

HIRETECH[®]

www.hiretech.biz

DISC FLOOR SANDER MODEL HT7-2

**From Serial Number
00607 (220/240 Volt) & 00466 (110/120 Volt)**



PRINTED IN THE UK

OWNERS MANUAL & OPERATING INSTRUCTIONS

NORTH AMERICAN SAFETY INSTRUCTIONS



WARNING: *This floor sanding machine must be grounded.*

This floor-sanding machine shall be grounded while in use to protect the operator from electric shock. The machine is provided with a three-conductor cord and a moulded three-contact grounding type attachment plug to fit the proper grounding type receptacle. The Green (or Green and Yellow) conductor in the cord is the grounding wire. Never connect this wire to other than the grounding pin of the attachment plug.

This floor-sanding machine is provided with an attachment plug as shown in sketch A. It is intended for use on a nominal 120 volt circuit. If a properly grounded receptacle as shown in sketch A is not available, an adaptor as shown in sketch 'C' should be installed as shown in sketch B if the outlet box that houses the receptacle is grounded. Be sure to fasten the grounding tab with a metal faceplate screw.



WARNING: *Risk of explosion.*

Floor sanding can result in an explosive mixture of fine dust and air. Use floor-sanding machine only in a well-ventilated area free from any flame or match.



WARNING: *Of potential injury.*

Moving Parts - to reduce the risk of injury, unplug the machine before replacing abrasive sheets or carrying out any form of adjustment or servicing.

USE AND APPLICATION

This machine is intended for commercial use connected with the laying and maintaining of wooden floors and decks.

These types of surfaces may be found both in commercial and household environments.

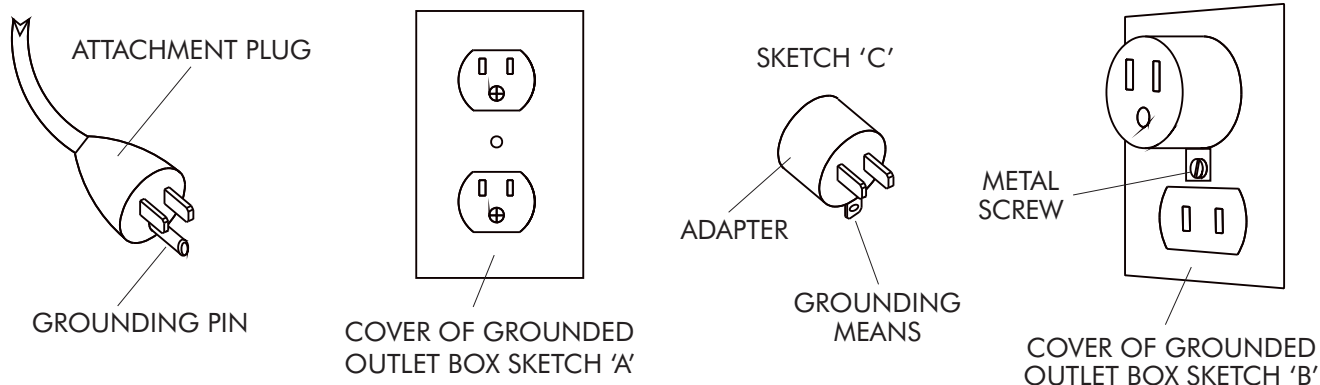

CONTENTS

WARNING	i	Parquet & Block Floors	5
MAINS CABLE WIRING - PLUG	i	Between Coats of Finish (Varnish)	5
SPARE PARTS	1	ABRASIVE PAPER GUIDE	6
SPECIFICATION	1	SERVICE AND ROUTINE MAINTENANCE	
SAFETY	1	General	7
SET UP		Visual Inspection	7
Assembly and Transport	2	Dust Control System	7
Installing Abrasive Disc	2	Drive	7
PREPARATION	2	Lubrication	7
OPERATION	2,3	Care of Motor	7,8
FLOOR SANDING TECHNIQUE		Sanding Pad Removal & Replacement	8
Drum Floor Sander	4	Sanding Pad Trimming	9
Disc Floor Sander	4	Adjusting the Castors	10
Orbital Floor Sander	4	Electrical Testing	10
Hand Sanding	4	FAULT FINDING	11
FLOOR TYPES		HT7-2 PARTS DRAWING	12
Sanding Plank & Strip Floors	4	HT7-2 PARTS LIST	13
Veneered, Laminated & Thinner Floors	4	HT7-2 CIRCUIT DIAGRAM	14
		DECLARATION OF CONFORMITY	15
		SERVICE & REPAIR	16

WARNING

For safe operation of this machine, read and understand all instructions. Look for the 'warning/caution' symbol.



This symbol means that if you do not follow the instructions injury can occur to the operator and damage to the machine and floor may result.

MAINS CABLE WIRING - PLUG

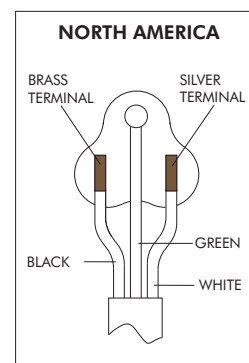
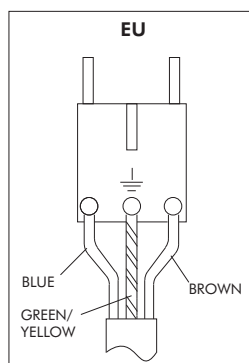
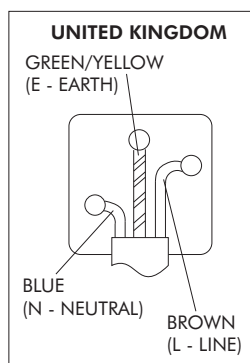

SPARE PARTS

Use Hiretech genuine spare parts only for service and repair. Use of non-approved parts will void the product warranty. See the back cover of this manual for the terms and conditions of the Hiretech Limited Warranty.

Hiretech® reserves the right to make changes or improvements to its products without prior notice.

SPECIFICATION

The HT7-2 Hiretech Edger (Disc Floor Sander) will sand hard and soft wood floors, cork and composition floors and any solid wood surface that requires rapid sanding and leveling to a fine finish. Ideal for confined areas such as closets and stair treads the HT7-2 will sand right up to the edge of a floor without damage to the base (skirting) board. Completely self contained with a high efficiency dust pick-up the HT7-2 is a high performance sander suitable for professional and home owner use.

Power Supply:	110/120 V 50/60 Hz 220/240 V 50/60 Hz
Off Load Current:	110/120 V 8A 220/250 V 5A
Average Load Current:	110/120 V 15A 220/250 V 8A
Noise:	100 dBA at 1metre (3' 3")
Switch:	Bias Off, double pole.
Motor:	Continuous heavy duty AC/DC self cooling 4 brush.
Motor RPM:	13,000
Disc RPM:	3,000
Sanding Pad:	7" (178mm) dia. Metal backed and rubber bonded.
Disc Guard:	High impact ABS with bronze bush.
Drive:	Hardened steel alloy pinion and large diameter aluminium bronze drive gear.
Moving Parts:	Sealed for life ball bearings.
Dust Pickup:	Seated oversize vacuum fan, disposable paper dust or cloth bag.bags
Vibration:	0.04 M ² H Aeq8 (8 Hr. RMS)
Weight:	16.4kg (36.2lbs)
Abrasive:	7" (178") dia. x 7/8" (22mm) dia. centre hole. 24 to 120 grit fibre or paper back.



CAUTION - read the following Safety and Operational notes before using your HT7-2 Disc Floor Sander.

SAFETY

1. For safety it is recommended that a residual current circuit breaker (ground fault interrupter) is used with this machine.
2. Check the operating voltage is correct and that the machine is switched OFF (O) before connecting to the power supply.
3. Never attempt to lock the switch in the ON (I) position with tape or by any other means.
4. Always disconnect from the power supply when changing the abrasive disc, servicing the floor sander, replacing the dust bag or leaving the machine unattended.
5. Always replace the dust bag (paper type) or empty the dust bag (cloth type) when the dust in the bag reaches the 'MAX' line or when the machine is left unattended.
6. Never dispose of or empty the contents of the dust bag into a fire or incinerator.
7. Never reuse the paper dust bag or use a non standard bag. Cloth type bags must be in good condition with no holes.
8. Always wear a dust mask when using the floor sander, handling the dust bag or cleaning the machine after use.
9. Wear ear protection when using the floor sander.
10. Ensure adequate ventilation of the work area to avoid the formation of a combustible mixture of flying dust and air.
11. Never smoke when using or servicing the floor sander or when handling the dust bag.
12. Never expose the machine to rain or damp. Always store in a dry place.
13. Stop the floor sander immediately if damage to the machine or abrasive disc is suspected.
14. Never allow the power cable to come into contact with the sanding disc when the floor sander is in operation. If the power cable becomes damaged and the inner conductors are exposed switch the power OFF and remove the plug before attempting to move the machine. The cable must be replaced by an authorised agent or qualified electrician using genuine Hiretech spare parts only.
15. Keep hands, feet and loose clothing away from all moving parts of the machine.
16. Punch down or remove all nails, screws, tacks and other fixings from the floor before sanding to prevent contact with the sanding disc.
17. Never use the machine above waist height as control will be lost.
18. Keep children and pets clear at all times.
19. If the machine should fail to operate refer to the fault finding guide on page 8.

SET UP

Assembly and Transport

1. Always carry the floor sander by the two handles with the bag frame in the up position and the power cable stowed around the bag frame. Protect the sanding disc with an abrasive disc and ensure that the clamp bolt is secure. Ensure that the floor sander is secure and cannot move when being transported in a vehicle. The floor sander is heavy. Take care when lifting and carrying the machine.
2. To prepare the floor sander for use place the machine on the floor and remove the cable from the bag frame. Check that the cable is in good condition and that all fittings are secure.
3. Lower the dust bag support frame and fit a paper dust bag following the instructions printed on the bag. Do not reuse or use a non standard bag. If a cloth type bag is used ensure that it is tied securely around the dust outlet and that the bag is in good condition with no holes.
4. To dismantle the floor sander reverse procedure 2 to 3 above.

Installing Abrasive Disc

1. Ensure the power cable is disconnected from the power supply.
2. Tip the floor sander upside down and rest the machine on its top and handles.
3. Remove the Wrench Ref.61 from the clips inside the skirt of the floor sander situated in between the castors and remove the Bolt Clamp Ref.59 and Washer Clamp Ref.58 from the centre of the sanding disc.
4. Select a suitable grade of abrasive disc (see Abrasive Paper Guide on page 5).
5. Place the bolt clamp through the centre of the washer clamp and abrasive disc and carefully thread the bolt into the sanding disc.



CAUTION - never fit more than one abrasive disc. If more than one abrasive disc is fitted the setup of the sander will be affected and the clamp bolt and washer and sanding pad will be damaged.

6. Using the wrench, tighten the bolt clamp ensuring that the abrasive disc is centred and the washer clamp is properly located. The bolt should be secure but do not try to over tighten. Heavy grit abrasive discs will seat down as you tighten the bolt so take care to ensure the washer

clamp is properly located. Heavy grit abrasive discs may not lie flat on the sanding disc, this is quite normal and the abrasive disc will flatten immediately upon operation.

7. Do not use damaged or incorrectly sized abrasive discs under any circumstance, damage will result to the machine and floor.

PREPARATION

1. Where possible remove all furniture from the area or room. The HT7-2 Disc Floor Sander features an efficient dust pickup, however, some dust will escape. Protect all vulnerable furnishings with dust sheets.
2. Remove all tacks, staples and other unwanted fixings from the floor. Failure to do so will result in damage to the abrasive disc and sanding disc.
3. Punch all nails below the surface of the floor using a suitable nail punch and hammer. Any screws used to fix boards should be counter sunk below the surface. During sanding, any nails or screws that become exposed must be punched or counter sunk further.
4. Firmly fix all loose boards or blocks.
5. Remove heavy wax, grease and dirt deposits by hand.
6. Sweep and vacuum the floor thoroughly to remove dirt and discarded fixings.
7. Ensure good ventilation by opening windows.
8. If sanding a work bench or similar work piece follow the instructions above to prepare it ready for sanding. Make sure that the work piece is secure. Never use the floor sander above waist height.

Note: Use Hiretechgenuine floor sander abrasives for the best sanding performance and finish.

OPERATION

1. Move the floor sander to the location of your work.
2. Make sure the switch is in the OFF (O) position then connect the power cable to a suitable power supply ideally located behind or to one side of the machine and work area.
3. Wear a dust mask and ear defenders.
4. Kneel behind the machine on one knee (use knee pads to protect knees) and hold both handles with the power cable held in the right hand in a small loop and then pass the cable over the right shoulder. Tilt the floor sander back so that the

sanding disc does not touch the floor or work piece.

5. Switch ON by pushing the ON/OFF switch to (I) position and hold in place with your thumb. To switch OFF (O), release the pressure on the switch and it will automatically return to the OFF position.



CAUTION - the HT7-2 Disc Floor Sander is a powerful machine. Always ensure you have a firm grip before switching on.

6. Now lower the floor sander slowly forward so that the abrasive disc comes into contact with the floor or work piece. At the same time move the machine in a sideways motion so when the abrasive disc comes into contact with the work surface it is moving to one side. This will ensure that the sander does not dwell in one position and damage the floor or work piece.



CAUTION - to prevent damage to the floor surface, work piece or machine follow these rules.

- i. Always ensure that the floor sander is moving when in operation and the sanding disc is in contact with the floor.
 - ii. Never lift the back of the machine when sanding.
 - iii. Never apply pressure to try to increase the rate of sanding. Damage to the floor or work piece will occur.
 - iv. Never bounce or drop the floor sander on to the floor or work piece, always lower the machine gently.
 - v. Never dwell in one place, move steadily at all times.
 - vi. Never allow the power cable to come into contact with the sanding disc.
7. When the dust in the dust bag reaches the 'MAX' line stop sanding. Switch OFF (O) and disconnect the power cable from the power supply and remove the paper dust bag. Turn the top of the paper dust bag over to stop the escape of dust and dispose of into a suitable container.

Never reuse the paper dust bag or empty it. Never dispose of it into a fire. If the cloth bag is used empty into a suitable container being careful to contain the dust. Do not dispose of the contents into a fire.

8. Fit a new paper dust bag, or refit the cloth bag. Reconnect the floor sander to the power supply and continue sanding.

9. When taking a break from work switch OFF 'O' and disconnect the power cable from the supply, remove and dispose of the paper dust bag, or empty the cloth bag as detailed in 7. above. Never leave the floor sander unattended with a dust bag in place containing dust.

10. On completion disconnect the power cable from the supply. Remove and dispose of the paper dust bag, or empty the cloth bag as detailed in 7. above. Replace the bag frame in its up position and stow the power cable. Leave the old abrasive disc in place to protect the sanding disc. Carry out maintenance as recommended in Maintenance and Servicing.



DANGER - never leave the floor sander unattended with dust in the dust bag. Always remove the dust bag and dispose of into a suitable container.

FLOOR SANDING TECHNIQUE

HT8-1.2 Floor Sander (Drum) - a powerful floor sander designed for the rapid leveling and sanding of all types of wood flooring excluding thin laminated or veneered floors. Load the sander with abrasive making sure that it is skin tight around the drum. Loose sheets will tear. Place the sander on the right hand wall (unless you are making an angled cut on uneven floors) with about two thirds of the floor in front of you. Start the sander with the drum off the floor then walk forward at an even pace and ease the drum on to the floor. As you near the end of the pass, gradually raise the drum off the floor. Practice this technique before turning on the sander.

Cover the same path you made on the forward cut by pulling the machine backwards and easing the drum to the floor as you begin the backward pass until you reach the original starting point, then ease the drum off the floor.

When two thirds of the floor is sanded, turn the floor sander around and sand the remaining third in the same way. Overlap the one third area by 0.6 to 0.9 meters (2 to 3 feet) with the two thirds area to blend the two areas together.



WARNING - never bounce the sanding drum or dwell in one place as this will sand dips and hollows in the floor.

HT7-2 Disc Floor Sander (Edger) - a powerful disc floor sander designed for sanding along the edges of a floor without damaging the baseboards or moldings. Also suitable for smaller areas where the HT8-1.2 Floor Sander will not reach like stair treads and closets load the abrasive disc making sure the retaining bolt is tight. Start the edger with the disc off the floor then lower the disc to the floor as you move the sander. Work progressively moving the sander in a sweeping motion from side to side.

HTF-2 Floor Sander (Orbital) - a orbital action floor sander designed for re-finishing, sanding between coats of varnish and re-surfacing floors in good condition. load the abrasive sheet, pad or strip. Start the sander, move immediately and sand in the direction of the grain using the same technique as the drum floor sander. For difficult to reach areas use the disc floor sander with a fine grit abrasive, or sand by hand.

Hand Sanding - to sand difficult to reach areas scrape and sand the floor by hand. Use a scraper to remove old finishes, always scraping in the direction of the grain, and then sand by hand using the same grit abrasive as you finished with when machine sanding. See Floor Sanding Technique diagrams on page 5.

FLOOR TYPES

PLANK & STRIP FLOORS

Old floors in good condition - when the floor is in good condition - no uneven edges, cupping or crowning of planks and strips - and you want to re-surface the floor, sanding back to new wood, start sanding in the direction of the planks or strips - with the wood grain. Start with a medium grit abrasive. Complete the first cut with the HT8-1.2 Floor Sander then sand up to the baseboards and door thresholds with the HT7-2 Disc Floor Sander, using a medium grit abrasive, blending the edges in with the main floor area. Sweep the floor. Using a medium/fine grit abrasive, sand the main floor area with the drum sander and then complete the floor with the edger using a fine grit abrasive. Sweep the floor. Finish sanding the main floor area with the drum floor sander using a fine grit abrasive. If the floor is in particularly good condition (level with no deep scratches or blemishes) you may re-surface the floor using the HTF-2 Floor Sander, however, as the sanding action of this machine is less aggressive than the HT8-1.2 Floor Sander the job will take more time.

Uneven floors - when the floor is uneven sand diagonally at 45° across the room in both directions using the HT8-1.2 Floor Sander with a coarse grit abrasive. Only make one cut on both diagonals, this will achieve a basic level. Now complete the floor as for a level strip or plank floor. Use the same grit abrasive as was used on the 45° cut for the first cut parallel to the planks or strips.

Floors with an existing finish - when re-finishing a floor remove as little of the existing surface as possible. If the old finish is worn and the floor is generally in good condition use the HTF-2 Floor Sander with **Hiretech** abrasive pads and strips which have been especially designed for re-finishing floors. These will maintain the integrity of any stain used to colour the wood and prepare the surface for a new coat of finish. If the floor is badly marked and scratched and has to be sanded back to new wood use the HT8-1.2 Floor Sander and HT7-2 Disc Floor Sander. Always try a medium grit paper first, particularly on a diagonal cut. If 90% of the old finish is removed and the floor is generally leveled, you do not need to use a coarse grit abrasive.

VENEERED, LAMINATED & THINNER FLOORS

Use the HTF-2 Floor Sander for veneered and laminated floors or thinner floors that may have been subjected to repeated sanding. The HTF-2 will remove old surface finishes and prepare the floor for re-finishing. Sand the floor using the same method as a strip, plank, or parquet floor. If the floor has deeper scratches or marks these should be sanded

out by hand and blended in with the main floor. To check the wood depth in the floor remove a baseboard or molding from around the edge of the floor. This should provide access to the edge of the floor for inspection.

PARQUET & BLOCK FLOORS

The grain of the wood will run in a number of directions so sand the floor in the direction of the main source of natural light in the room. If there is no source of natural light sand in the direction of the longest side of the room or, if the room is square, in the direction the furniture is laid out and how people normally use and view the room.

This technique will help mask any imperfections in the

floor. Complete the sanding operation as detailed for plank or strip floors.

BETWEEN COATS OF FINISH (VARNISH)

Use the HTF-2 Floor Sander to sand between coats of floor finish, particularly when using water based varnishes. These types of finishes tend to raise the wood grain when first applied to raw wood. Allow each coat of varnish to dry completely following the manufactures directions. Use Hiretech abrasive pads to sand between each coat of varnish. The fine abrasive pads will remove light brush/applicator marks and raised grain while maintaining the integrity of the coat of varnish applied.

FLOOR SANDING TECHNIQUE

Level uneven floors.

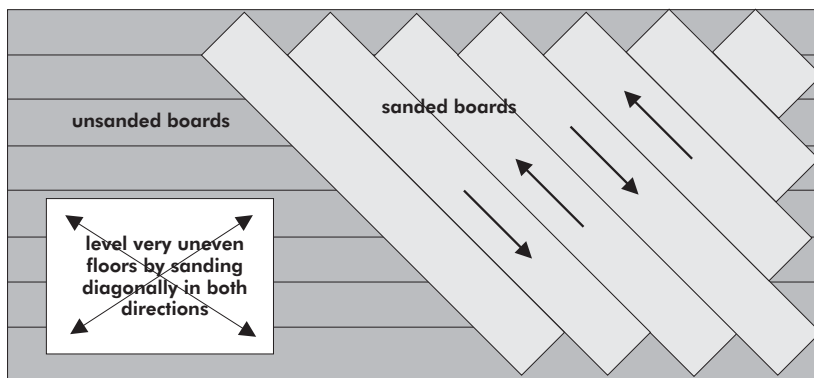

Sand main floor area.

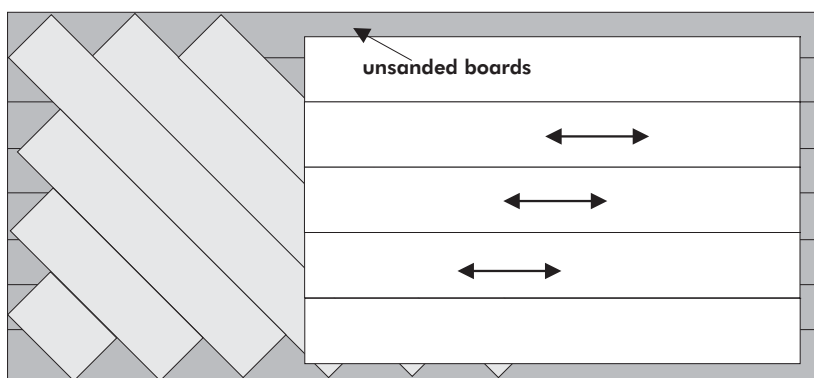

Plank and Strip Floors - sand in the direction the boards are laid, with the wood grain.

Parquet and Wood Block Floors - sand in the direction of the main source of natural light. If there is no natural source of light, sand in the direction of the longest side of the room. If the room is square, sand in the direction the furniture is laid out and how people normally use the room.

Sand and blend edges in with main floor area.

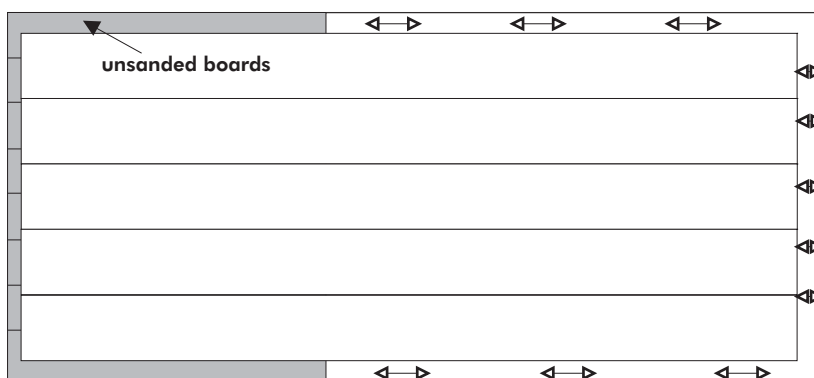

FLOOR SANDER ABRASIVE GUIDE

Abrasive Grade	Floor Type and Condition
Grit P24 Open Coat (Very Coarse non-glogging)	For removing surface coatings from old floors such as varnish, stains and wax polishes. For the rapid sanding and removal of scratches and marks. Sanding level the joints of sub-flooring like particle board and masonite.
Grit P24 (Very Coarse)	For the rapid sanding and removal of scratches and marks. Sanding level the joints of sub-flooring like particle board and masonite.
Grit P36 to P50 (Coarse/Medium)	For removing surface coatings from old floors such as varnish, stains and wax polishes. For the rapid sanding and removal of scratches and light marks. Sanding level the joints of sub-flooring like particle board and masonite.
Grit P60 to P80 (Medium)	For the rapid sanding and removal of scratches and light marks. Sanding level the joints of sub-flooring like particle board and masonite.
Grit P100 to P120 (Medium/Fine)	Intermediate sanding of all types of wood floor. For final sanding of all types of wood floor.
Grit P150 - P180 (Fine/Very Fine)	For final sanding of all types of wood floor. First sanding of cork or composition floors. For sanding between coats of solvent based and 2 pack varnishes.

DO NOT OVER-SAND USE ONLY AS HEAVY GRADE ABRASIVE AS IT TAKES TO DO THE JOB. PROGRESS FROM FIRST GRADE USED THROUGH FOLLOWING GRADES TO REMOVE ALL VISIBLE SANDING MARKS. DO NOT MISS A GRADE.

FLOOR SANDER ABRASIVES

Hiretech Abrasives	HT8/DU8 FLOOR SANDER SHEET 20 & 50/CASE	HT8 EX FLOOR SANDER BELTS 5/CASE	HT7/SUPER 7 EDGER DISC FIBRE BACKED 25/CASE	HT7/SUPER 7 EDGER DISC PAPER BACKED 25 & 50/CASE	HTF FLOOR SANDER SHEET ADHESIVE BACKED 25 & 50/CASE	HTF ABRASIVE PAD 20/CASE
Hiretech recommend the following abrasive range which are suitable for all floor types and applications.						
P16	-	-	01025	-	-	-
P24 Grit Open Coat	01001	-	-	01044	-	-
P24 Grit	01002	01010	01026	-	-	-
P36 Grit	-	01011	-	-	-	-
P40 Grit	01003	01012	-	01045	01750	-
P50 Grit	-	01013	01027	-	-	-
P60 Grit	-	01014	-	-	01751	-
P80 Grit	01004	01015	01028	01046	01752	-
P100 Grit	-	01016	-	-	-	-
P120 Grit	01005	01017	01030	01048	01754	-
P150 Grit	-	01018	-	-	-	-
P180 Grit	-	-	-	-	01756	-
P280 Grit/Backing Pad	-	-	-	-	-	01769

SERVICE & ROUTINE MAINTENANCE



CAUTION - maintenance and repairs must be carried out by authorised personnel only. To prevent injury, always remove the power cable from the power supply before undertaking any work on the machine. Do not operate this machine unless it is fully assembled and all guards are in place. Use Hiretech genuine spare parts only.

General

1. Always make a list when first examining the machine, to remind you of parts or action needed on completion of repair/service.
2. The HT7-2 is subject to high speeds. All screws should be fitted using a suitable thread lock compound.
3. On completion of any work or service on an electrical tool or appliance statutory safety tests must be carried out by a competent person and recorded (see Testing for Electrical Safety page 7 and 8).
4. The HT7-2 needs no lubrication during routine servicing.
5. Always ensure that the electrical supply is disconnected before starting any routine servicing or repair.

Visual Inspection

1. To clean the machine and remove dust, use a vacuum cleaner to avoid damage and prevent inhalation of dust.
2. Examine all guards and mechanical parts for condition including the Disc Guard Ref.54 which should be undamaged and moving freely.
3. Examine the sanding pad, a worn or damaged pad must be replaced to maintain performance and to avoid injury. There must be a minimum of 4mm ($\frac{5}{32}$ ") 'tread depth'.
4. Examine the power cable for damage. If the outer insulation shows the slightest of abrasions or the inner conductors are exposed then the cable must be replaced. The cable must not be repaired with tape or insulation sleeve.
5. Ensure all labels are sound, readable and secure.
6. Check that the castors are sound and moving freely. If a castor is found to be loose or damaged then the 'cutting' angle must be checked and reset as necessary (see Setting Castors page 9). Replace damaged castors.

7. Check the condition of the Bolt-Clamp Ref.59 and clean the threads.
8. Check that the Wrench Ref.61 is in place and in good condition.
9. If a cloth type bag is in service check the condition, clogged dust bags or bags with holes make for inefficient dust pickup.

Dust Control

1. Turn the sander upside down and rest the machine on the handles. Check the dust skirt for pieces of abrasive disc and build up of dust. Clean as needed.

Drive

1. The drive gear does not require maintenance under normal operating conditions.

Lubrication

1. The HT7-2 features sealed for life bearings which do not require any lubrication. In the unlikely event that a bearing has to be replaced use a Hiretech genuine spare part only as the grease contained in the bearings is special. A standard bearing is not suitable and may result in further damage.
2. Should the gearbox require service the gear housing and gears must be cleaned thoroughly and the gearbox refilled with grease Part No. 011270. This is a special grease designed for the high speed and temperatures generated within the gear box. Under no circumstance must a standard automotive grease be used. Using such a grease will result in gear failure and damage to the motor and other components. The grease may also melt and leak from the gear box staining the floor or work piece being sanded.

Care of Motor

1. The motor must be kept clean and free from grease and dust.
2. The motor brushes must be checked regularly. As it is necessary to remove the Cover Motor Ref.4 during routine electrical testing, it is then a simple matter to check the condition of the motor brushes and avoid costly breakdowns.
3. Replace ALL FOUR motor brushes when any one brush has worn to 12mm ($\frac{15}{32}$ ") or less in length. Brushes MUST slide freely in the brush holders.

There is no need to remove or disconnect any internal leads when changing the brushes, only the small braided shunt (pigtail) is disconnected to release the brush.

4. To replace the motor Brushes Ref. 12.
 - i. Remove the four Screws Ref.1 from the Cover Motor and lift the cover off.
 - ii. Remove the four Spring Brush Ref.17 and set to one side. The springs are removed by pushing the spring tag in towards the brush and lifting out.
 - iii. Using a cross recess screwdriver remove the four brush shunt (pigtail) retaining screws and lock washers Ref.16.
 - iv. Remove the four brushes.
 - v. Thoroughly clean the brush assembly and housing using a soft brush and a suitable vacuum cleaner.
 - vi. Inspect the four brushes for damage or wear and if any one brush is found to be damaged or worn to a length of $\frac{5}{8}$ "(16mm) or less then replace all four brushes. Always replace all four brushes together.
 - vii. When replacing brushes ensure that each brush moves freely in each holder and fit the brush with the shunt (pigtail) in such a position as to allow free movement throughout the brush life. Ensure that each brush shunt is connected securely with the Screw and Washer Ref.16. (two spare screws and washers are provided with each pack of brushes). The brush should be fitted so that the brush shunt (pigtail) is at the bottom of the brush.
 - viii. Refit the brush springs by inserting into the holder with the coil spring over the brush then push in until the tag comes into contact with the holder, slide the tag away from the brush and release. The brush spring will clip into position. Check the springs and brushes for correct alignment and free movement.
 - ix. Carry out electrical safety test and record results (see Testing for Electrical Safety page 7 and 8).
 - x. Finally check that all leads and cables are clear of moving parts and will not be trapped when refitting the cover motor.
 - xi. Refit the cover motor and secure with the four Screws Ref. 1.

Sanding Pad

It is very important to maintain the HT7-2 Edger sanding pad in perfect condition for score free sanding and to maximise the life of the abrasive disc.

In normal operation the sanding pad needs little maintenance apart from periodic trimming, however, if the pad is worn below its minimum thickness or it is damaged it must be replaced.

Reasons for Removing/Replacing the Sanding Pad

1. The sanding pad is worn below its minimum tread thickness of 4mm ($\frac{5}{32}$ "
2. Physical damage that cannot be removed by trimming.
3. To gain access to maintain/repair the fan, gears, motor and bearings.
4. To remove an obstruction from the dust pickup.

Removal and Replacement of the Sanding Pad

1. Disconnect the edger from the power supply.
2. Turn the edger upside down and rest it on its handles.
3. Remove the Bolt Clamp (Ref.59) and Clamp Washer (Ref.58).
4. Using a 18mm (11/16") hardwood dowel approximately 150mm (6") long, lock the Fan Intake (Ref.31) in position to stop it turning by inserting the dowel through the underside of the edger to the rear of the sanding pad.
5. Using service tool Part No.011730 Sanding Pad Wrench, remove the sanding pad in a counter clockwise direction (right hand thread). Take care to support the edger.

Note: The sanding pad can be tight, if needed use a soft mallet to tap the wrench to help removal.



CAUTION - when the sanding pad becomes loose carefully remove it by hand. Take care not to lose the Shims (Ref.56) which may come away with the sanding pad. These shims, which may vary in quantity with a minimum of two, are used on the Shaft Drive (Ref.47) to pack out the sanding pad.

6. Thoroughly clean the Guard Disc (Ref.54) and refit all the Shims (Ref. 56) if removed.
7. Fit a new sanding pad and tighten using the service tool.

Reasons for Trimming the Sanding Pad

1. As part of routine maintenance.
2. The sanding pad has been damaged.
3. The sanding pad has been replaced.
4. The sanding pad has been removed to gain access to other components or to remove an obstruction from the dust pick-up.
5. The castors have been replaced and/or adjusted.

Trimming the Sanding Pad

1. Disconnect the edger from the electrical supply and place the edger on a flat, smooth surface such as a work bench. Visually check to see that only the front of the sanding pad is in contact with the surface it is standing on. That is, the castors are adjusted so that the edger is 'tipped' forward.
2. Use a piece of paper or 0.005" feeler gauge to check under and around the sanding pad to confirm that only the front part of the sanding pad is in contact with the surface it is standing on.

The correct contact area is illustrated in the diagram below.

If the contact area is wrong or can not be identified accurately check and adjust the castors as detailed below in - Adjusting the Castor

3. To trim the sanding pad fix a piece of fine grit floor sander abrasive (120 grit) face up to a solid flat board that is large enough to stand on and operate the edger. Place the board on a flat even floor and the edger on top of the board with the pad over the abrasive. Do not fit an abrasive disc.



CAUTION - make sure that the Clamp Bolt (Ref.59) is secure and properly tightened

4. Connect the edger to the power supply, stand on the board and tip the edger back and switch 'ON'. Carefully lower the edger so that the sanding pad comes into contact with the abrasive. Move the edger from side to side across the abrasive under its own weight for a few seconds. Tip the edger back and switch 'OFF'
5. Disconnect from the power supply and check the condition of the sanding pad. You should witness an even surface with no high or low spots around the whole surface of the sanding pad in the contact area as shown in the diagram below.

Note: Do not hold the edger in place, always keep it moving across the abrasive sheet. Do not over trim the sanding pad or you will reduce it's life. Do not lift or force the edger while trimming the pad, allow the edger to move under it's own weight. The sanding pad minimum tread depth is 4mm (5/32").

Sanding Pad Trimmed Contact Area

Sanding Pad Static Contact Area

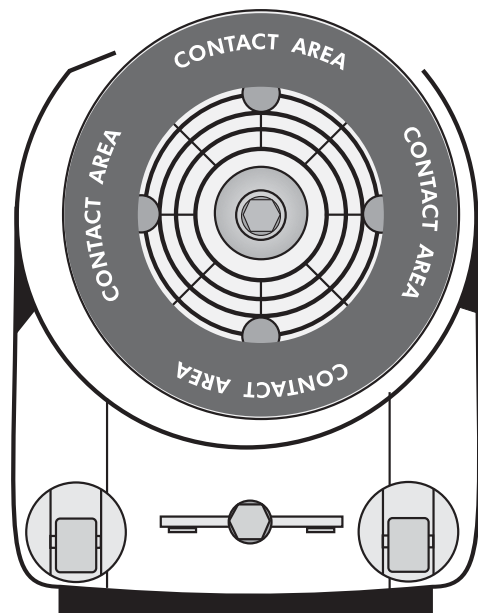
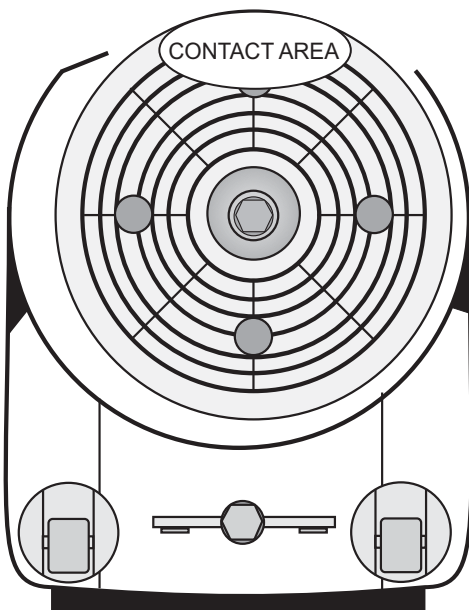

Adjusting the Castors

The castors are set to achieve the correct contact area across the sanding pad as illustrated in the diagrams above.

1. To check the castor setting place a clean sheet of glass across the two castors and the sanding pad. Inserting a 0.005" feeler gauge (or a sheet of paper) between the glass and the sanding pad. Check the correct contact area is achieved (see diagram above - Sanding Pad Static Contact Area)

An alternative method is to lightly dampen the rubber sanding pad and then place the glass sheet across the two castors and sanding pad. Apply light pressure to the glass sheet, which will witness the dampened area of the sanding pad in contact with the glass.



WARNING - use toughened glass only with a minimum thickness of 6mm (1/4") with rounded/polished edges. Take care when handling glass. Always use suitable gloves, eye protection and protective clothing.

- 2 To adjust the castors loosen the two castor lock nuts using the special tool Part No. 011720 and 5mm ball allen key. Adjust the castors and check the contact area on the sanding pad. When the contact area is correct tighten the two castor lock nuts securely. Use a suitable thread lock compound. Finally check the contact area is still correct after tightening the castor lock nuts.
4. Trim the sanding pad as detailed above.

Electrical Testing.



CAUTION - testing for electrical safety should only be undertaken by a competent person and all results recorded. Do not exceed 1250 volt insulation test duration of 3 seconds.

1. Examine the power cable for damage. If the outer insulation shows the slightest of abrasions or the inner conductors are exposed then the cable must be replaced. The cable must not be repaired with tape or insulation sleeve.
2. Open and check the mains plug for condition, loose connections, damaged wires, etc.
3. Remove the four Screws Ref.1 and lift off the Cover Motor Ref.4 to check the switch, connections, leads etc. Pay special attention to any gaskets, 'O' rings and seals intended to exclude dust from the switch and switch housing area. These must be maintained in good condition.
Carefully brush and vacuum clean the switch and brush block assembly and inside the cover motor.
4. Refit the cover motor taking care not to trap any leads.
5. Using a piece of insulation tape or a small soft wedge lock the bias off switch in the 'ON' position.
6. Use the standard procedure test for electrical safety (Class I Earthed Appliances [U.K.]). Do not exceed 1250 volt insulation test duration of 3 seconds.
7. Record the test results.
8. Complete a functional (run) test and record results.



CAUTION - when undertaking a functional (run) test make sure the machine is secure. Remember the sanding disc will rotate..

FAULT FINDING

FAULT	CAUSE	ACTION
The machine does not run.	<p>The power cable is not connected to the power supply.</p> <p>The motor brushes are worn.</p> <p>The voltage is too low.</p>	<p>Connect the power cable to the power supply.</p> <p>Replace the motor brushes.</p> <p>Check the main power complies with the machine's serial plate data.</p>
The machine will not pickup dust.	<p>The dust bag is full.</p> <p>There is an obstruction in the dust pickup.</p>	<p>Replace the paper dust bag or empty the cloth dust bag.</p> <p>Disconnect the machine from the power supply, turn the machine over and check for obstruction.</p>
The machine does not sand evenly.	<p>The sanding pad is damaged.</p> <p>The castors are out of adjustment.</p>	<p>Check and replace the sanding pad.</p> <p>Check and adjust the castors.</p>
The sander scores or burns the wood.	The machine is not being operated properly.	Read the instructions, do not apply pressure when sanding.
The machine runs slow.	<p>The voltage is low.</p> <p>A motor brush is not making contact.</p>	<p>Check the supply voltage.</p> <p>If an extension lead is being used it is undersize and/or it is coiled.</p> <p>Check and refit or replace the motor brushes.</p>

DISC FLOOR SANDER MODEL HT7-2

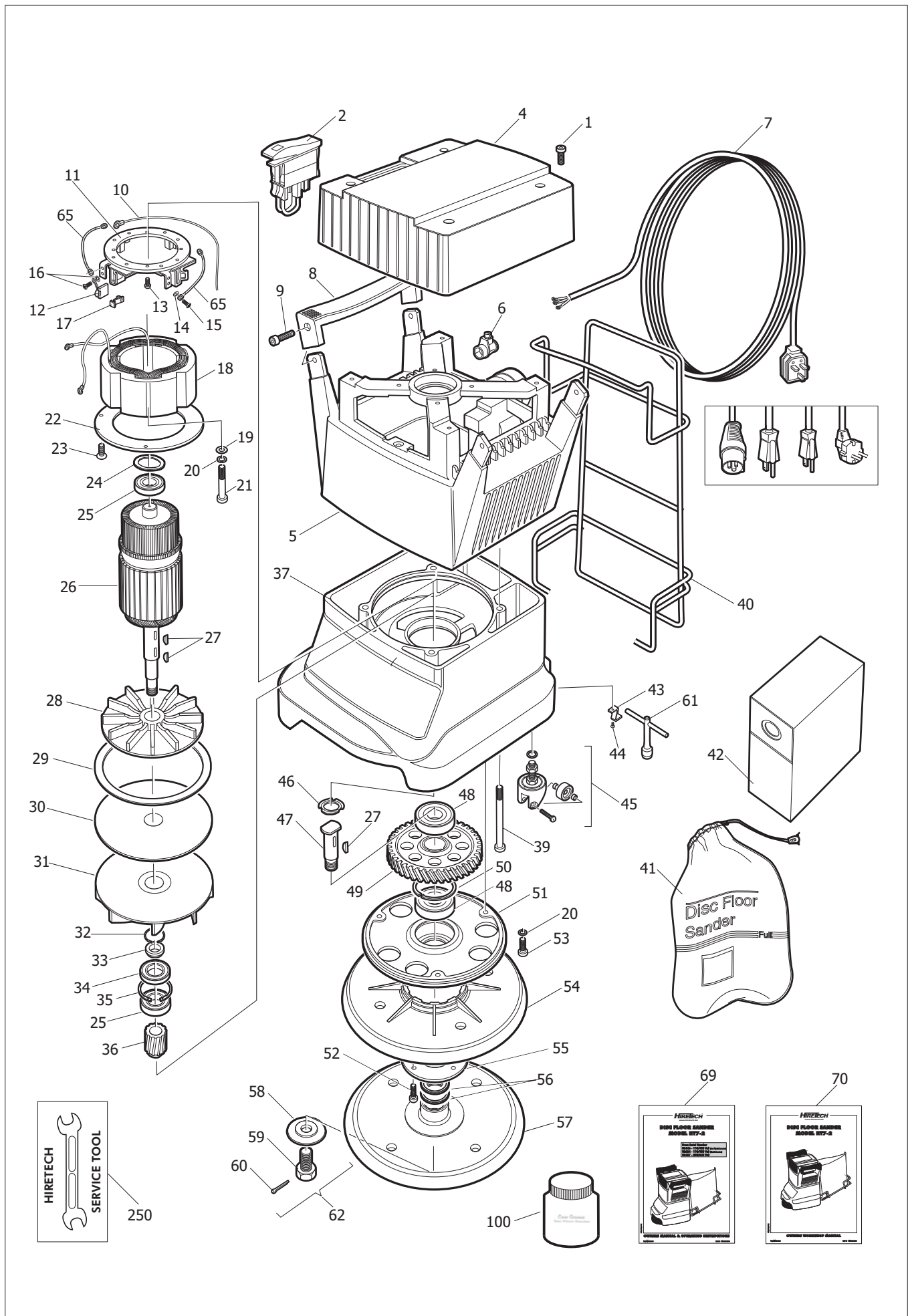

DISC FLOOR SANDER MODEL HT7-2

Ref.	PSTK	Pack Qty.	Description	Ref.	PSTK	Pack Qty.	Description
1	010010	4	Screw	46	010540	1	Spring Load
2	011600	1	Switch 220/240 Volt (Bias Off)	47	010550	1	Shaft Drive
2	011610	1	Switch 110/120 Volt (Bias Off)	48	010560	2	Bearing
4	010050	1	Cover Motor	49	010570	1	Gear Drive
5	010070	1	Housing Motor	50	010580	1	Ring Retaining
6	010080	1	Strain Relief	51	010590	1	Cover Gear
7	010090	1	Cable Main Assembly 220/240 Volt (UK)	52	010220	4	Screw & Washer Set
7	010100	1	Cable Main 110 Volt (NA)	53	010610	3	Screw
7	010110	1	Cable Main Assembly 220 Volt (EEC)	54	010620	1	Guard Disc
7	010120	1	Cable Main Assembly 240 Volt (AUS)	55	010630	1	Retainer
7	010130	1	Cable Main Assembly 110 Volt (UK)	56	010640	4	Shim
8	010140	2	Handles Pack of 2	57	012310	1	Sanding Pad (Metal Backed)
9	010150	4	Screw Handle	58	010660	1	Washer Clamp
10	010160	1	Cable Switch Assembly	59	010670	1	Bolt Clamp
11	010170	1	Brush Block Assembly	60	010680	1	Pin Cotter
12	010180	4	Brush Motor	61	010690	1	Wrench
13	010190	4	Screw Pack of 4	62	010720	1	Washer, Clamp and Pin Cotter Kit
14	010200	4	Washer	65	010750	2	Brush Shunt
15	010210	4	Screw	69	011680	1	Owners Manual & Operating Instructions
16	010220	4	Screw and Washer Set	70	011820	1	Owners Workshop Manual
17	010230	4	Brush Spring				
18	010240	1	Field 110/120 Volt HT7				
18	010250	1	Field 220/240 Volt HT7				
19	010260	2	Washer Clamp				
20	010270	5	Washer Lock				
21	010280	2	Screw				
22	010290	1	Baffle				
23	010300	3	Screw				
24	010600	1	Spring Washer				
25	010320	2	Bearing				
26	010330	1	Armature 110/120 Volt				
26	010340	1	Armature 220/240 Volt				
27	010350	3	Key				
28	010360	1	Fan Motor				
29	010370	1	Gasket				
30	010380	1	Plate Exhaust				
31	010390	1	Fan Intake				
32	010400	1	Ring Retainer				
33	010410	1	Spacer Bearing				
34	010420	1	Seal				
35	010430	1	Ring Retainer				
36	010440	1	Pinion				
37	010450	1	Housing Gear				
39	010470	4	Screw				
40	010480	1	Frame Bag Support				
41	010490	1	Bag Dust Cloth				
42	07038	25	Disposable Paper Dust Bag HT7/HTF Pack 2 (box 25)				
42	07040	50	Disposable Paper Dust Bag HT7/HTF (box 50)				
43	010510	2	Clip Wrench				
44	010520	2	Screw				
45	010530	2	Castor & Nut				

The following items are not illustrated.

Special Tools

250	011720	1	Service Tool - Castor Adjuster
250	011731	1	Service Tool - Sanding Pad Fitting/Removal
250	011740	1	Service Tool - Pinion Fitting/Removal
250	011850	1	Service Tool - Extractor Gear Cover
250	011860	2	Service Tool - Extractor Seal

Consumables

110	010760	1	Carton Transit
100	011270	1	Grease Gear Disc Floor Sander

HT7-2 CIRCUIT DIAGRAM

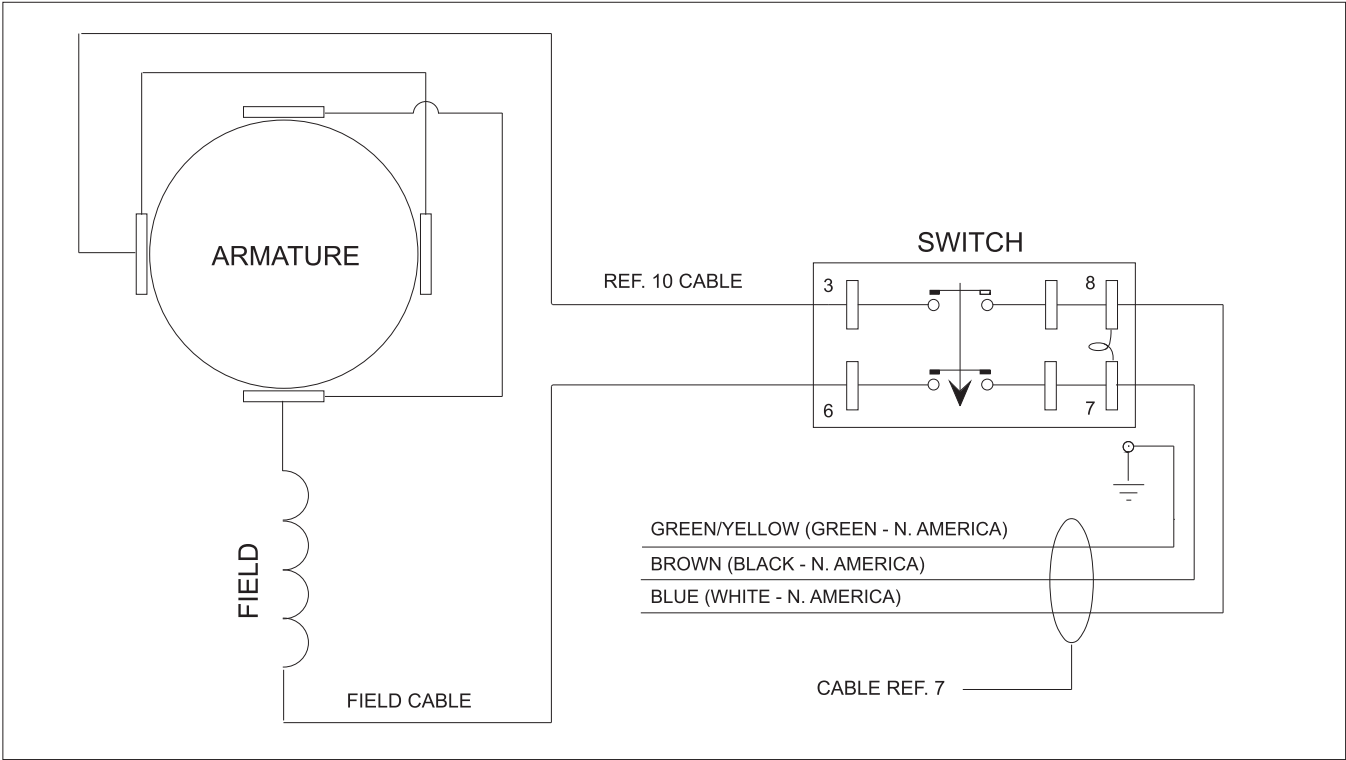

DECLARATION OF CONFORMITY

This declaration identifies the product, manufacturer's name and address, and applicable specifications recognised in the European community.

DECLARATION OF CONFORMITY



Manufacturer's Name: Hire Technicians Group Ltd.

Manufacturer's Address: Chalk Hill House
8 Chalk Hill
Watford
Herts Wd19 4BH

declares that the product:

Product Name: Hiretech Disc Floor Sander

Model Name: HT7.2 230 Volt 50Hz Insulation Class 1
HT7.2 110 Volt 50Hz Insulation Class 1

conforms to the following:

Machinery Directive (Harmonised)	89/392-EU as amended
Low Voltage Directive (Harmonised)	73/23/EU as amended
Electromagnetic Compatibility Directive	89/336/EU as amended

following the provisions of the directives:

89/392/EU, 93/44EU, 73/23/EU, 93/68/EU, 89/336/EU, 91/368/EU,
92/31/EU

EN60 335-1-88 (HD 251-1-3) BS 3456-201	EN292-1-91
EN292-2-91	EN60204-1-92
EN55014-93 (BS 800)	EN 50082-1-92
IEC 745-2-4 (HD 400.2) (BS 2769-2-2.4)	

electrical safety test procedures comply with:

IEC 335 pt. 1-2, HD251 1-3 1982, BS 2769 & 3456, CSA C22.2,
KEMA K78A1/W1 & W3, NEMKO 503./89, DIN VDE 0700 1/04.88
HD 264.S2 15/07.86

Where the product is licensed to carry a National Approval Mark it is certified that all such products comply with the terms of that license.

C.J. Hedger, Director of Engineering. 1 April 2012

SERVICE & REPAIR

Contact your reseller for the name of your local service agent. Service and repairs undertaken by non-approved service agents will void the product warranty. If you should have difficulty in obtaining service please contact your distributor nearest to you at the address given below.

For the latest list of Hiretech dealers check on the Hiretech web site at www.hiretech.biz/contact/dealerlist.html.

Name	Address	Telephone, Facsimile, Email & Web
Hiretech Pty Ltd	Unit 2 62 Owen Street Glendenning NSW 2761 AUSTRALIA	Tel: +61 29625 9337 Fax: +61 29625 4770 Email: sales@hiretech.com.au Web: www.hiretech.com.au
Abmast Inc (Canada East)	6935 Rue Picard Saint-Hyacinthe QC J2S 1H3 CANADA	Tel: (800) 361-0854 Fax: (800) 341 0554 Email: asimard@abmast.com Web: www.abmast.com
S T C as Praha	Konevova 33 130 00 Praha 3 CZECH REPUBLIC	Tel: + 4202 22585810 Fax: +42 02 22584421 Email: ruzena.muzikantova@stcnet.cz
Tool Matic A/S	Vedskollevej Herfolge 4681 DENMARK	Tel: +45 56250708 Fax: +45 56250705 Email: sales@tool-matic.dk Web: www.tool-matic.dk
VIF Diffusion	rue du Chateau-BP70112 59052 Roubaix Cedex 1 FRANCE	Tel: +33 320 207880 Fax: +33 320 207889 Email: infos@vif-furniture.com
Tucks Limited	Hume Avenue Park West Industrial Estate Dublin 12 REPUBLIC OF IRELAND	Tel: +353 (01) 621 5555 Fax: +353 (01) 621 5563 Email: info@tucks.ie Web: www.tucks.ie
Turner Morris (Pty) Ltd	39 Robyn Road Benrose P.O. Box 27252 2011 SOUTH AFRICA	Tel: +27 11 618 4313 Fax: +27 11 618 2620 Email: dbnsales@turnermorris.co.za Web: www.turnermorris.co.za
Hire Technicians Group Ltd	Chalk Hill House 8 Chalk Hill Watford Herts WD1 4BH UNITED KINGDOM	Tel: +44 01923 332424 Fax: +44 01923 332525 Email: sales@hiretech.biz Web: www.hiretech.biz
Hiretech North America Inc	PO Box 1564 Cliffotn Park NY 12065 USA	Tel: +1 518 348 1300 (800) 563 2472 Fax: +1 518 348 1400 (800) 465 5981 Email: sales.usa@hiretech.biz Web: www.hiretech.biz

HIRETECH LIMITED WARRANTY

Hiretech warrants to the original purchaser that the Hiretech machine covered by this warranty is free from defects in workmanship and materials. Should any part fail in the period of two years from the date of the original purchase as a result of a defect, Hiretech will (at its option) either repair or replace the part without charge provided that the machine has been operated in accordance with the Owners Manual and Operating Instructions.

Should any such defect arise, please contact your nearest authorised repair agent. Standard service over land mainland freight costs will be refunded on warranty repairs at the sole discretion of Hiretech or the authorised repair agent. If the repair is non-warranty, the customer will be advised before any work is undertaken.

This warranty is the sole warranty by Hiretech and is in lieu of all other warranties express or implied and releases Hiretech from all other obligations and liabilities.

This warranty does not apply to normal wear and tear to the machine, and in particular does not cover normal wear parts such as mains cable, wheels, switches, relays, brushes, rubber parts, hoses and bearings. This warranty also does not cover, and Hiretech will not be liable for, excessive wear caused by abnormal use.

Hiretech will under no circumstances be liable for alterations to the machine or for damage caused by third persons, or for misuse or abuse of the machine, or damage caused during transportation. Repairs of the machine made or attempted by persons other than those specifically authorised by Hiretech shall render this warranty void and Hiretech will not be liable for such repairs, the cost of such repairs, or the consequences of such repairs. Where spare parts are used on the machine and they do not conform to Hiretech specifications, this warranty will be rendered void and Hiretech will not be liable.

Hiretech will not be liable for any indirect or consequential loss, damage, cost or expense of any kind whatever and however caused whether arising under contract, tort (including negligence) or otherwise including (without limitation) loss of production, loss of profits or contracts or of operating time or goodwill or anticipated savings.

*Every effort has been made to present all information in this publication accurately, however no liability is accepted for any inclusions or advice given or for omissions from this publication. Hiretech reserves the right to make changes or improvements to its products without prior notice. Hiretech® is a registered trademark of Hire Technicians Group Ltd., all other trademarks are the property of their respective owners.
© Hire Technicians Group Ltd.*



MANUFACTURED BY

HIRE TECHNICIANS GROUP LIMITED
CHALK HILL HOUSE, 8 CHALK HILL, WATFORD,
HERTS, WD19 4BH. UNITED KINGDOM

TEL: +44 (0)1923 332424 FAX: +44 (0)1923 332425
E-mail: sales@hiretech.biz Web: www.hiretech.biz