

SAFE LIFTING



**PRECAST/TILT-UP CONCRETE
PANELS & ELEMENTS**



REINFORCING • PRECAST • TILT-UP

Introduction

The team at Reid™ prides itself on being much more than a supplier of components for the precast and tilt-up industries. We work in partnership with our customers in all facets of planning and preparation, design, manufacture, installation, rigging, lifting and bracing...all critical stages in the safe, efficient and fast construction of precast and tilt-up structures.

This guide to site safety is just one example of our commitment to the industry. Keep it with you at all times while on site and if you have any questions, we are just a phone call away.

SAFE SITE RULES

1. Even before you begin the job, make sure you plan it out in as much detail as possible. Crane locations, sequence of panel lifting, placing and fixing, positions of overhead wires...anything that could affect the safety of your crew as the job progresses.
2. Work together with the supervising engineer and the builder. Keep the communication lines open at all times, and if you have a concern, discuss it with them before you proceed.

3. Use this SAFE LIFTING booklet as your guide to the correct INSTALLATION, RIGGING, LIFTING and BRACING methods of concrete panels.
4. Ensure that your workmates are also aware of the importance of safe site procedures.
5. **KEEP THIS BOOKLET WITH YOU AT ALL TIMES WHILE ON SITE.**
6. For those few occasions when you need more information about safe lifting and bracing practices, you can contact our specialist engineers on 1300 780 250.
7. Always use the right tools as well as the lifting and bracing components that are specified.

SYMBOLS THAT SAVE

As you go through this guide, you'll notice several symbols that are vital in ensuring the safety of you and your crew. Take a look below, and every time any one of these symbols appears in the following pages, make sure you STOP... READ ... UNDERSTAND and ONLY THEN, continue.



**ATTENTION:
IMPORTANT INFORMATION**



WEAR FOOT PROTECTION



WEAR HEAD PROTECTION



NO WELDING



WEAR EYE PROTECTION



WEAR HEARING PROTECTION

CONTENTS

SECTION	PAGE
1. Planning and Preparation	4
2. Identification	6
3. Anchor Installation	12
4. Stripping and Rigging	20
5. Lifting	31

SAFETY STANDARDS

The recommendations contained in this guide are consistent with the following publications:

- Standards Australia
- AS3850-2003 Tilt-up Concrete Construction
- Australian Safety and Compensation Council
- National Code of Practice for Precast, Tilt-up and Concrete elements in Building Construction
- National Precast Concrete Association of Australia
- Precast Concrete Handbook
- WorkSafe Victoria
- Industry Standard, Precast and Tilt-up Concrete for Building
- Construction and Erection of Bridge Beams
- WorkSafe WA
- Code of Practice: Tilt-up and Precast Concrete Construction

1.1 BEFORE YOU DO ANYTHING...

1. Ensure you have all the appropriate engineering drawings on-site:

- Certified Lifting and Bracing Drawings which detail:
 - all load conditions
 - loads to be applied to element during lifting and bracing
 - lifting point design
 - rigging design
 - bracing design

2. Familiarise yourself with relevant Codes of Practice, (refer to page 3 of this Guide).

 *3. ONLY USE fully qualified crane companies/operators and riggers.

4. Carry out lifting/bracing in accordance with Certified Lifting and Bracing Drawings.

5. Any queries should be referred to a suitably qualified engineer.

6. Prior to lift, identify that lifting points, clutches etc. are as specified in the Certified Lifting and Bracing Drawings.

7. Check the Proof Load Test Tag on clutches.

8. Check for any wear and tear on lifting components before you start each lift.

9. Check that lifting inserts and clutches are compatible (design and brand).

 *10. ALWAYS maintain a CLEAR ZONE around lift area, (in accordance with Codes of Practice).

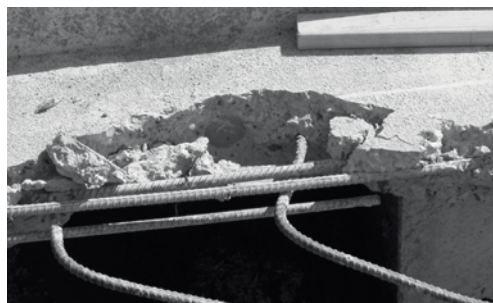

Incorrect use of Foot Anchor instead of Eye Anchor



A complex series of errors – site preparation, incorrect bracing

1.2 SAFETY MAKES SENSE

Every year hundreds of people are injured at work, in factories and on construction sites. The risk of injuries occurring can be significantly reduced if you take the time to follow the steps outlined in this booklet.

Reid™ lifting clutches are designed with a factor of safety 5 times the rated WLL.



1.3 COMMITTED TO SAFETY

Reid™ is committed to assisting you to have as safe a workplace as possible. It all starts with our design engineers providing Certified Lifting and Bracing drawings. The components we supply are all rigorously tested to ensure they conform to the appropriate standards and have specified safety margins built in.

When you use Reid™ lifting and bracing component systems, you are getting much more than construction products; we work with you right from the design stage through every facet of installation, rigging, lifting and bracing.

It is our aim that you will find Reid™ Concrete Lifting Systems:

- **Faster** • **Safer** • **Easier** • **Smarter**

2.1 ANCHORS AND LIFTING CLUTCHES

Anchors or lifting inserts are cast-in fixings that allow the connection of the lifting rig to the precast or tilt-up concrete element to be lifted. These precast elements include:

- Factory precast manholes, pipes, beams, columns, wall panels, stairs, arches, etc.
- Site cast tilt-up, wall panels, bridge beams, etc.

The various systems have been designed to allow safe, efficient lifting from various directions without damaging concrete surfaces.

The safe lifting and installation of any of these elements requires:

- The correct anchor to be specified and cast in
- The correct number of anchors to be used
- The correct positioning of the anchors and additional reinforcement (if specified)
- The correct rigging of the lifting slings
- The correct minimum concrete strength at time of lift
- Correct clutch engagement

2.2 TYPES OF LIFTS

There are three types of lifts, (different types of anchors may be used for each lift type).

NOTE: Refer section 4 for more detailed information.

1. Face (or Top) Lift

The initial direction of lift is in line with the anchor axis. The lift puts the anchor mainly in tension,

1. Face or Top Lift

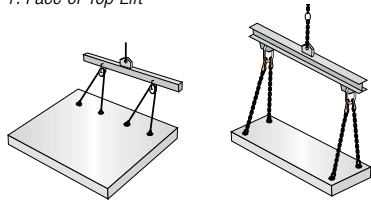

2. Edge Lift

The initial direction of lift is transverse, or perpendicular, to the anchor axis which puts the anchor into shear to begin with and then move into tension as the lift is completed.

3. Rotational Edge Lift

The initial lift is shared by some of the anchors. This load puts the anchors into in-plane shear at the start, which becomes tension as the load is rotated for placement.

Whereas other anchors that start in tension are subject to shear towards the end of the lift.

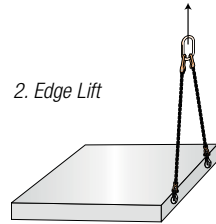

3. Rotational Edge Lift

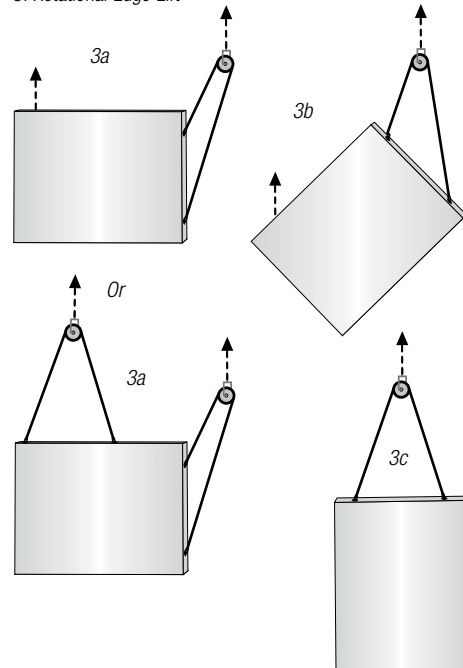

2.3 TYPES OF LIFTING ANCHORS

Anchors can be classified as either Facelift, Edgelift or General Lifting.

2.3.1 FaceLift™ Anchors

These anchors are cast into the face or top of the element with a void former used to form the void into which the clutch is placed to engage the anchor. They are supplied as an assembly consisting of a Void Former, Anchor and Chair. There are various types of FaceLifters as follows:

a) Ramset™ FaceLifter™

The Ramset™ FaceLifter™ uses a "plate anchor" in its assembly.

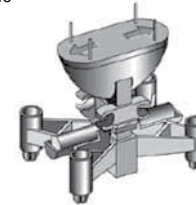

b) SwiftLift™ FaceLifter™

The SwiftLift™ FaceLifter™ uses a "SwiftLift™ Foot Anchor" in its assembly.



c) EconoTilt™ FaceLifter™

The EconoTilt™ FaceLifter™ uses a "SwiftLift™ Foot Anchor" in its assembly.



2.3.2 EdgeLift™ Anchors

EdgeLift™ anchors are cast into the edge of the element with a void former used to form the void into which the clutch is placed to engage the anchor. The different types of EdgeLift™ Anchors are as follows:

a) SwiftLift™ JAWS™: Load range 3t, 5t, 7t & 10t WLL (Max)

These anchors are a plate style anchor. All three types require a Shear Bar for shear lifts. The JAWS™ ULTRA™ uses an additional reinforcing bar in accordance with the Technical Data Sheet.

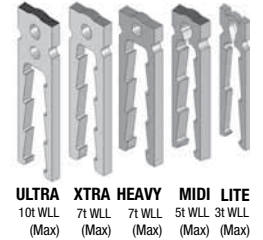

b) Two Hole Anchor System: Load range 6t & 9t WLL (Max)

6t & 9t WLL (Max) These anchors are a plate style anchor and must be used with an additional reinforcing bar to achieve full capacity in tension. It also requires a Shear bar id used for Shear Lifts.



c) SwiftLift™ EdgeMaster™: Load range 2.5t WLL (Max)

2.5t WLL (Max) This anchor uses a plastic Void Former, SwiftLift™ Foot Anchor and an EdgeLift™ Bracket in its assembly. It is sold re-assembled as shown in the picture.



2.3.3 EdgeLift™ anchors have two lifting configurations, one for shear and one for tension.

Shear Lift

A shear bar MUST be used with ALL plate style anchors for shear lifts.



The leg of the shear bar stops the anchor pulling out when tilting the panel. Correct installation of the shear bar is critical – refer Reid™ Technical Data Sheet.

Tension Lift



Reid™ EdgeLift™ Anchors with a second hole require an additional reinforcing bar. This bar will increase the lifting capacity of the anchor in weak concrete or thin elements. The additional reinforcing bar must be used as specified to achieve full capacity.

2.3.4 General Lifting Anchors

These anchors are cast into the precast element with a void former used to form the void into which the clutch is placed to engage the anchor. They are used for a variety of precast elements including pit lids, water tanks, wing walls, box culverts, pipes as well as bridge beams. The type of anchor used depends on the geometry and mass of the precast element, refer to the lifting procedure. The different types of General Lifting Anchors are as follows;

a) SwiftLift™ Foot Anchor:

Load range: 1.3t-32t WLL (Max)



b) SwiftLift™ Combination Anchor:

Load range: 1.3t-5t WLL (Max)



c) SwiftLift™ Eye Anchor:

Load range: 10t-32t WLL (Max)



d) Spread Anchor:

Load range: 2.5t-5.0t WLL (Max)



NOTE:



- The distance between anchors or from any edge as well as the length of the anchors are critical factors that affect the capacity of the anchor.
- The concrete strength also affects the lifting capacity of the anchor, (short anchors may need higher strength concrete)

ALWAYS USE THE LONGEST POSSIBLE ANCHOR AVAILABLE IN ANY PARTICULAR SIZE RANGE.



The foot anchor holds into the concrete by developing a “pull out cone” in the concrete. The diameter of the cone on the surface of the concrete is approximately six times the depth of the anchor.

2.4 LIFTING CLUTCHES

There are two main types of Lifting Clutches which engage with the head of the Anchor, (refer to diagram 2.4.1 below)



Reid™ SwiftLift™ Clutch SwiftLift™ Jaws™ Clutch

Special variations of these designs are available to enable remote release from the anchor.

2.5 CLUTCH IDENTIFICATION

All clutches should carry specific identification. Refer to diagram 2.5.1

IMPORTANT MARKINGS TO LOOK FOR ON CLUTCHES:

- 1- The manufacturer's logo to ensure the clutch complies with relevant codes.
- 2- The nominal size or class of anchors that the clutch is designed to be used with. WLL rating (to AS3850)
- 3- A test tag showing that the clutch has been proof tested by an appropriately qualified laboratory to the required proof load for the particular clutch rating/class.

The date of the test and the date it is required to be revalidated.

NOTE: It is a requirement of Australian Standards AS3850 that all clutches are tested every 12 months.

4- Manufacturing Batch Certification. A unique number that identifies the specific batch of manufacture.

Diagram 2.5.1

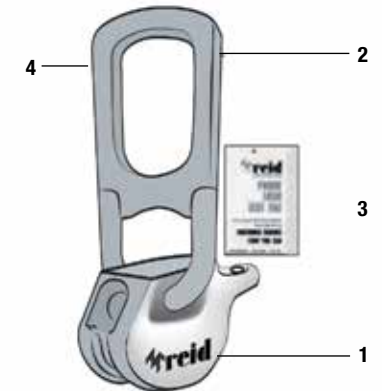

SwiftLift™ clutch with tag

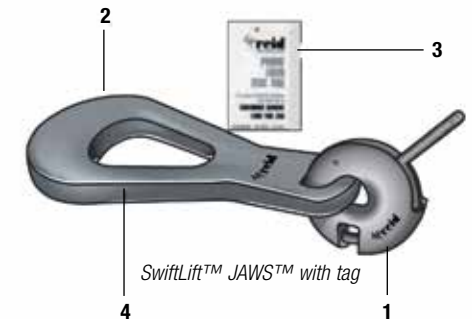

SwiftLift™ JAWS™ with tag

2.6 ANCHOR IDENTIFICATION

The key things to look for include:

1. The Manufacturer's Name/Logo

This enables you to identify the manufacturer and therefore their published performance information and specification of their product.

2. Load Class

The Load Class/Rating of the anchor should be easily visible to the naked eye when the anchor is correctly cast into the concrete. This to allows for quick confirmation prior to use.

3. Length of Anchor

This is relevant for SwiftLift™ Foot & Eye Anchors as they are designed into a variety of different precast elements which can vary in length, width and thickness. The length of the SwiftLift™ Anchor is a critical aspect of the design.

4. Manufacturer's batch number

A manufacturer's batch number is stamped on anchors. These are manufactured from mild steel plate such as the SwiftLift™ Jaws™ and the Two Hole Anchor.

SwiftLift™ Foot Anchor Identification

Diagram 2.6.1 shows the important markings to look for on Reid™ SwiftLift™ Foot anchors.

- 1- The manufacturer's name/logo
- 2- Nominal load class or rating
- 3- Length of anchor



Diagram 2.6.1
SwiftLift™ Foot Anchor identification

SwiftLift Combination Anchor and SwiftLift Eye Anchor Identification

Diagram 2.6.2 shows the important markings to look for on the head and shaft of the Reid™ SwiftLift™ Combination and SwiftLift™ Eye Anchors.

- 1- The manufacturer's name/logo
- 2- Nominal load class or rating

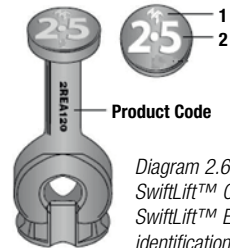

Diagram 2.6.2
SwiftLift™ Combination and
SwiftLift™ Eye Anchor
identification

SwiftLift™ Jaws™ Anchor identification

Diagram 2.6.3 shows the important markings to look for on the Reid™ SwiftLift™ Jaws™ anchors.

- 1- The manufacturer's name/logo
- 2- Nominal load class or rating
- 4- The manufacturer's batch number

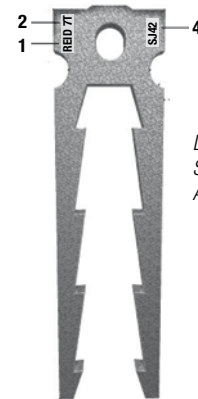

Diagram 2.6.3
SwiftLift™ Jaws™
Anchor identification

Two Hole Anchor Identification

Diagram 2.6.4 shows the important markings to look for on the Reid™ Two Hole anchors.

- 1- The manufacturer's name/logo
- 2- Nominal load class or rating
- 4- The manufacturer's batch number

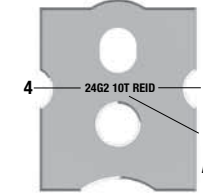

Diagram 2.6.4
Two Hole Anchor
identification

SwiftLift™ Edgemaster™ Identification

Diagram 2.6.5 shows the important markings to look for on the SwiftLift™ EdgeMaster™ anchors. Refer to the SwiftLift™ foot anchor ID section for more detail regarding markings.

- 1- The manufacturer's name/logo
- 2- Nominal load class or rating
- 3- Length of anchor



Diagram 2.6.5
SwiftLift™ Edgemaster™
Anchor identification

Ramset™ FaceLifter™ Identification

Diagram 2.6.6 shows the important markings to look for on the Ramset™ FaceLifter™ anchors.

- 1- The manufacturer's name/logo
- 2- Nominal load class or rating
- 3- Length of anchor
- 4- The manufacturer's batch number

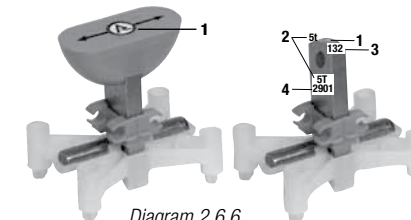

Diagram 2.6.6
Ramset™ FaceLifter™ Anchor identification

SwiftLift™ FaceLifter™ and EconoTilt™ FaceLifter™ Identification

Diagram 2.6.7 shows the important markings* to look for on the SwiftLift™ FaceLifter™ and EconoTilt™ FaceLifter™ anchors.

*Refer to SwiftLift™ Foot anchor ID section for more detail regarding markings.

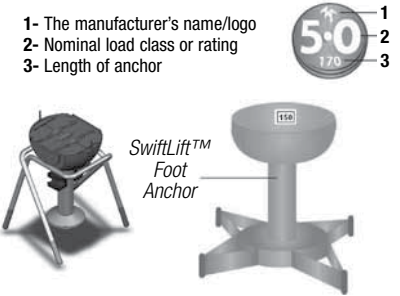

Diagram 2.6.7
SwiftLift™ FaceLifter™ and
EconoTilt™ FaceLifter™ anchor identification

Spread Anchor Identification

Diagram 2.6.8 shows the important markings to look for on the Reid™ Spread anchors.

- 1- The manufacturer's name/logo
- 2- Nominal load class or rating

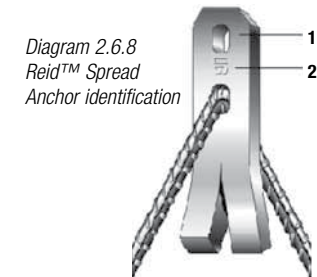

Diagram 2.6.8
Reid™ Spread
Anchor identification

3.1 VOID SELECTION

3.1.1 Rubber Round Void Former

- The void former is a round shape that produces the exact void in the concrete for the clutch to engage correctly. It also comes with a bolt attached to enable fixing to formwork or mould.
- Can be attached to the form for positive anchor location.
- Also used to “puddle” into wet concrete after pouring.
- Available to suit SwiftLift™ Anchor sizes: 1.3t, 2.5t, 5.0t, 10.0t, 20.0t, 32.0t.
- Typically used when an anchor needs to be located in the top surface of a product (as cast)



3.1.2 Steel Round Void Former

- Specifically designed for applications where it is necessary to strip formwork without removing the void.
- Typically used when an anchor needs to be located in the bottom surface of a product (as cast)
- Has a long lifespan.
- Simple to use and fast to install.
- Available to suit SwiftLift™ Anchor sizes: 1.3t, 2.5t, 5.0t, 10t



3.1.3 Articulated Void Former



- Typically used when an anchor needs to be located in the side surface of a product (as cast)
- Provides a positive connection to the anchor.
- Used as an alternative to the rubber void former for a longer service life.
- Require regular maintenance to ensure freedom of movement.
- Available to suit SwiftLift™ Anchor sizes: 1.3t, 2.5t, 5.0t.

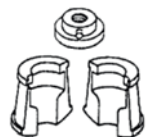

3.1.4 Colleted Void Former

- Manufactured from steel for optimal life.
- Suited perfectly for centrifugally spun pipes.
- Ideal for applications requiring positive anchor location and rigidity.
- Available to suit SwiftLift™ Anchor sizes: 1.3t, 2.5t, 5.0t.

3.1.5 Plastic Round Void Former



- Typically used as a replacement for the rubber round void former when the number of products to be cast is very small.
- Manufactured from plastic.
- Round in shape and disposable.
- Available to suit SwiftLift™ Anchor sizes: 2.5t, 5.0t.

3.1.6 SwiftLift Jaws Void Former



- Colour Coded to match SwiftLift™ JAWS™ Anchors.
- Made from high quality reusable rubber.
- Available to suit SwiftLift™ JAWS™ Anchor sizes: 10.0t (Blue), 7.0t (Orange), 5.0t (Terracotta).

3.2 EDGELIFT ANCHOR INSTALLATION

3.2.1 SwiftLift™ JAWS™ Anchors

1. Void installation

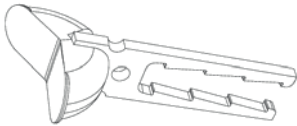

- Flex open Void Former to allow anchor installation.
- Install Anchor into void former
- Anchor and void assembly

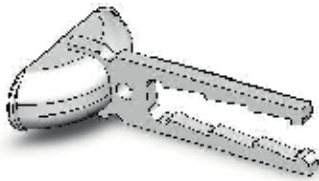

2. Positioning Anchor-Void Assembly

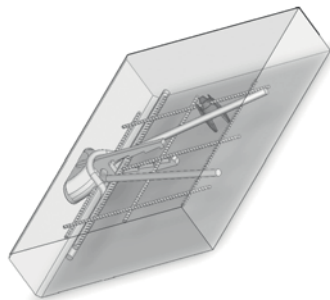

- The Anchor and Void assembly is placed into position. Central mesh and perimeter bar are located between the JAWS™ legs.

3. Setting Bolts

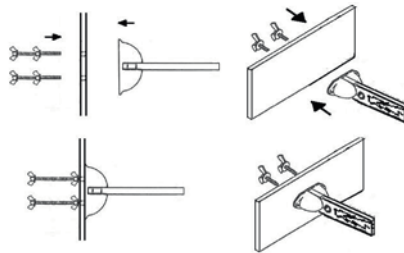

- Secure anchor and void assembly to the sideform with two setting bolts.

4. Shear Bar and/or Tension Bar Installation



- Install Shear Bar and use tie wire to secure the anchor, void, mesh and Shear bar into position.

DO NOT WELD TO ANCHOR

- For JAWS™ ULTRA and Two Hole Anchor, install Tension Bar as well. Once again use tie wire to secure into position.

DO NOT WELD TO ANCHOR

5. Final Set-up position for:

- JAWS™ Standard – SJS
- JAWS™ Heavy – SJH

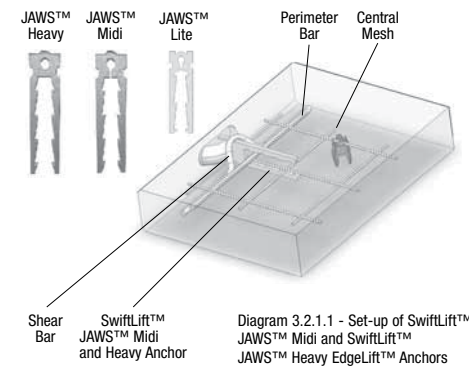

c. JAWS™ Ultra™ – SJU

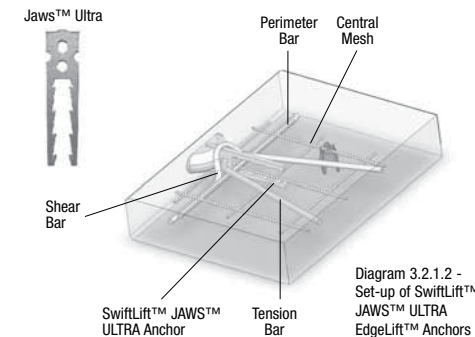

NOTES from Diagram 3.2.1.1 & 3.2.1.2

- Shear Bar to be installed over the head of the anchor seated in the semi-circle cut-out of the anchor.
- Perimeter Bar pass through the legs of the anchor
- Central Mesh to be positioned between the legs of the anchor.
- Tension Bar for JAWS™ ULTRA to be positioned through second hole of anchor as show in diagram 3.2.1.2

3.2.2 SwiftLift™ EdgeMaster™

1. Fix the EdgeMaster™ to the sideform

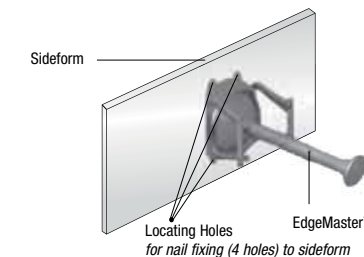
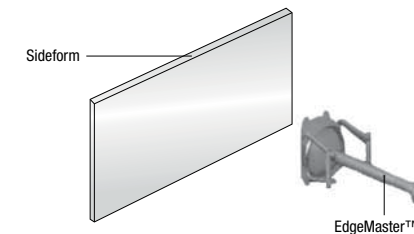

- The EdgeMaster™ is pre-assembled with void former, anchor and shear bar bracket.
- The EdgeMaster™ Void former has four locating holes.
- The EdgeMaster™ can be fixed to the form by nailing or with double sided tape.

- Nailing - Drive four nails through the EdgeMaster™ Void former locating holes to attach to sideform.
- Double Side Tape - Attach the double sided tape to the face of the EdgeMaster™ Void former then fix to sideform.

3.3 FACELIFT ANCHOR INSTALLATION

FaceLift™ Anchors are cast into the concrete with void formers to create the void in the concrete. Once the void former is removed, the Lifting Clutch is attached to the head of the anchor.

FaceLift™ anchors are supplied as preassembled sets to match common panel thicknesses, the void former 5-8mm below the concrete panel surface to allow for easy finishing of the panel.

The preassembled sets which are placed in the panel during setup (before concrete pour) need to be attached to the reinforcing mesh to ensure they remain in the correct position and orientation during the pour and finishing.

3.3.1 Ramset™ FaceLift™ Anchors

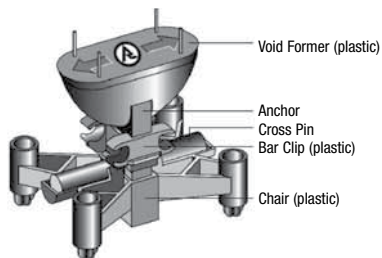

1. Installing Ramset™ FaceLifters™ (For 125 and 150mm only)



Place two Bars on Barclip of FaceLifter™
Tie-Wire FaceLifter™ in Place
FaceLifter™ Secured

2. Location and Orientation of Ramset™ FaceLifters

- FaceLift™ Anchor location must be as per shop drawings or lifting design drawings.
- The Ramset™ FaceLift™ anchor must be placed as per the arrow indicators on the top of the Void Former (fig 2).

- Incorrect orientation can result,
 - Inadequate rotation of panel
 - Inadequate capacity of anchor

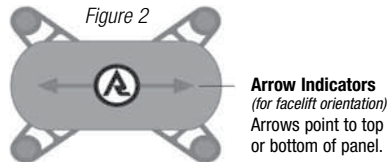

3.3.2 SwiftLift™ FaceLift™ Anchors

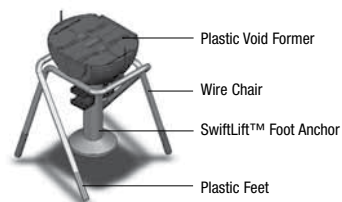

1. Installing SwiftLift™ FaceLifters™

Anchors to be installed as per the photo shown below.

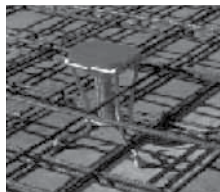

2. Location and Orientation for SwiftLift FaceLifters

- FaceLift™ Anchor location must be as per shop drawings or lifting design drawings.
- The SwiftLift™ FaceLift™ anchor must be placed as per the arrow indicators on the top of the Void Former as shown below.
- Incorrect orientation can result,
 - Inadequate rotation of panel
 - Inadequate capacity of anchor

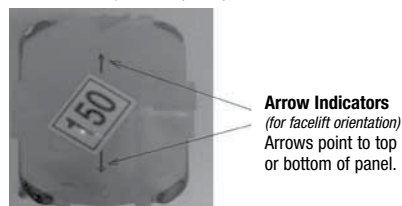

3.4 GENERAL LIFTING ANCHOR INSTALLATION

SwiftLift™ Foot, Combination and Eye Anchors are cast into the concrete with a void former used to create the void into which the clutch is placed to engage the anchor. As there are a number of different types of void formers, the installation method varies for each type.

3.4.1 Rubber Round Void Former Installation

1. Flex the void former open to allow anchor installation.

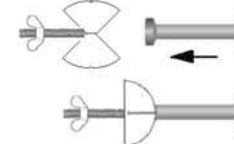

2. For secure attachment to the form, pass the Setting Bolt through the form and fasten with wing nut.

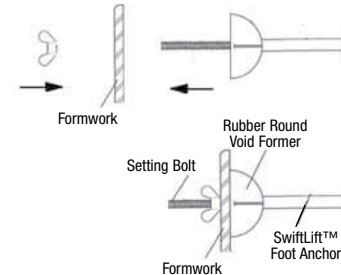

3. If you are going to puddle the anchor in, hold the assembled Void Former and Anchor by the Setting Bolt and puddle the anchor in until the face of the void is flush with surface of concrete.

NOTE: Using a concrete vibrator tool around the anchor should be minimised

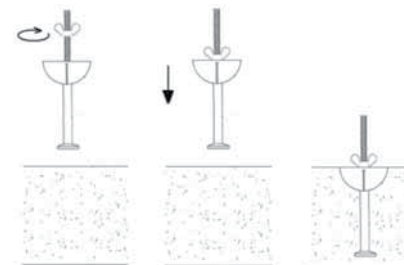

3.4.2 PUDDLING

Puddling is the practice of installing anchor and void assemblies in fresh concrete. Where puddling is required, contact Reid for advice on the best method for your application and anchor assembly.

3.4.2 Steel Round Void Former Installation

1. Secure Rubber ring around anchor head.

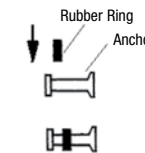

2. Secure Steel Round Void Former to the formwork with a Setting Bolt.

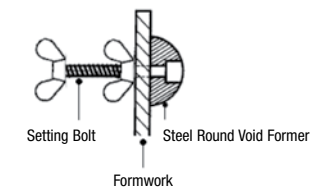
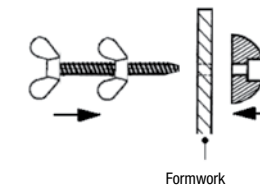

3. Insert SwiftLift™ Anchor with the attached rubber ring into the Steel Round Void Former.

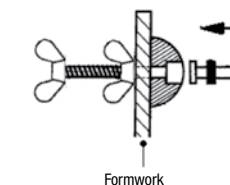

4. SwiftLift™ Anchor in final position secured to a Steel Round Void Former

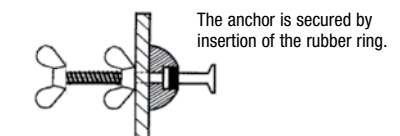

3.4.3 Articulated Void Former Installation

1. Attach Articulated Void Former to SwiftLift™ Anchor.

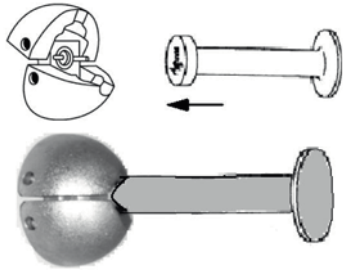

2. Secure assembled Articulated Void Former to formwork as per diagram below.

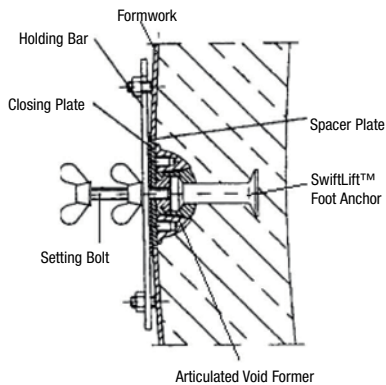

3.4.4 Colleted Void Former Installation

1. Attach the Collet Set and Collet Collar to the SwiftLift™ Anchor head.

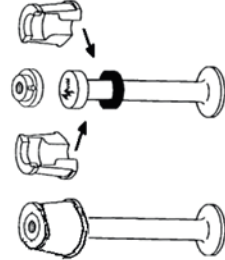

2. Insert the SwiftLift™ Anchor with the attached Collet Set and Collet Collar into the Steel Void Former.

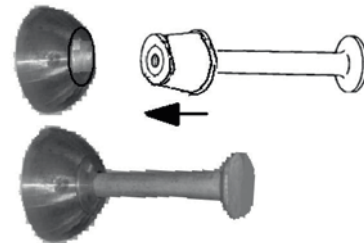

3. Secure the assembled Colleted Void Former with SwiftLift™ Anchor to formwork as per diagram below.

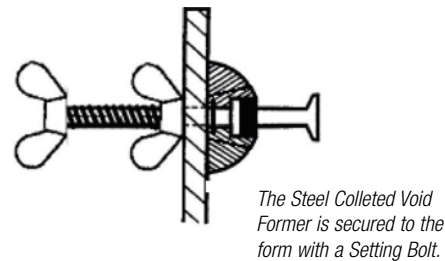

3.4.5 Plastic Round Void Former Installation

1. Attach Plastic Collet Set to SwiftLift™ Anchor Head.

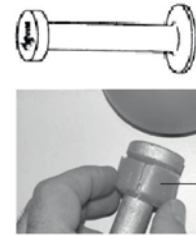

Plastic Collet Set on head of SwiftLift™ Anchor

2. Insert SwiftLift™ Anchor with attached Plastic Collet Set into the Plastic Void Former.

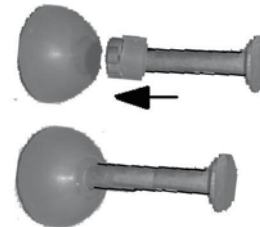

3. If using a SwiftLift™ Foot Anchor, the assembly with Round Plastic Void Former can be used with a Plastic Chair or it can be puddled into the wet concrete.

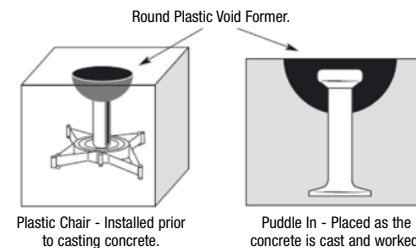

3.4.6 Installing SwiftLift™ Combination or Eye Anchors

SwiftLift™ Combination/Eye Anchors require additional reinforcing steel, (hanger bars) to be connected to the anchor in order to achieve the required lifting capacity. The length of hanger bar required with each of these anchors in 10MPa concrete is given in table 3.4.6.1. Refer SwiftLift™ Design Manual for further information.

Table 3.4.6.1

SwiftLift™ Combination/Eye Anchors Working Load Limits - 10MPa concrete(1)		
Anchor	Bar Diameter (mm)	Bar Length(1) (mm)
1.3	8	1000
2.5	12	1500
5.0	16	2000
10.0	20	2700

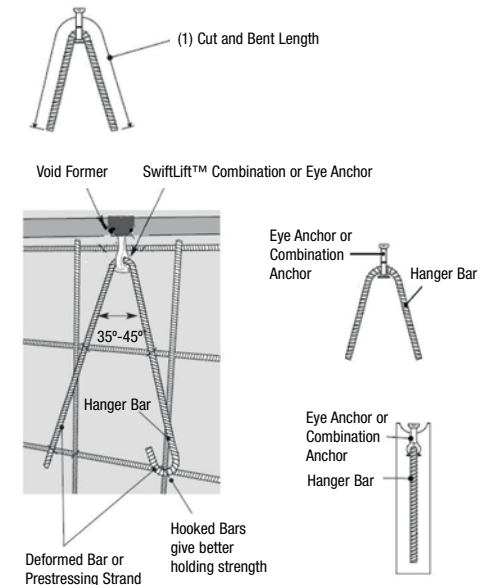

4.1 REMOVING VOID FORMERS & STRIPPING

4.1.1 EdgeLifter™ Void Formers

- Strip sideform, formwork and false work from the panel.
- The EdgeLifter™ Void former is levered out of concrete as shown in the diagram below.

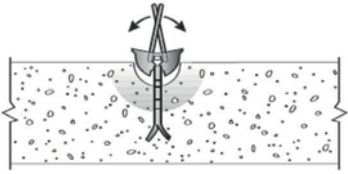

4.1.2 FaceLifter™ Void Formers

- Correct removal of FaceLifter™ void former is shown in the images below.



A – Hammer screwdriver (off centre) into void former



B – Lift void former



C – Repeat "A" from opposite end

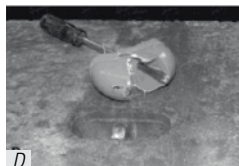

D – Remove void former exposing FaceLift™ anchor head

4.1.3 SwiftLift™ Void Formers

1. Steel Round/Colleted Void Formers

Correct removal of these void former types is shown in the images below:

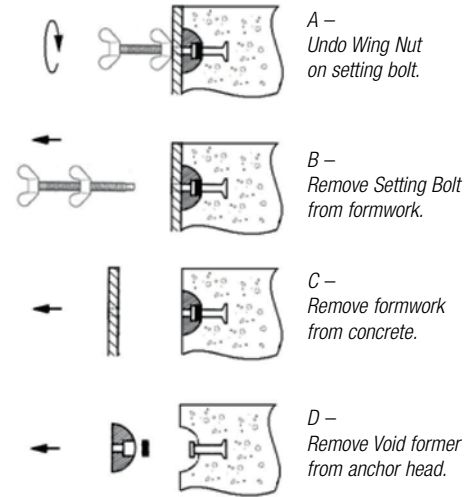

The Steel Round Void Former can also be used for applications where it is necessary to strip without removing the void from the formwork.

2. Rubber Round Void Formers

For rubber round void formers and articulated void formers there are holes located on the void which aid the removal process. Refer to diagram below for detail.

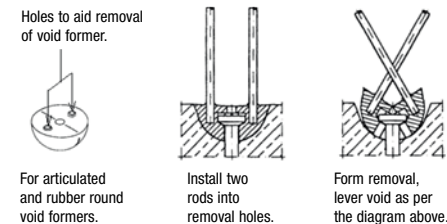

3. Plastic Round Void Formers

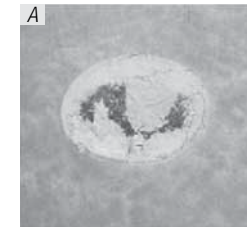

A – The recess former as seen after concrete has set.



B – Using a self-drilling hex head wood screw and electric drill, drill into the centre of the recess former.

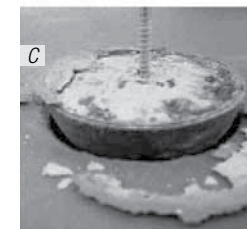

C – The screw will contact the centre of the lifting anchor head and the recess former will pop with ease.



D – The recess former is removed leaving a clean void and the collet, which is easily pulled off to allow the clutch to engage on the anchor.

4.2 CLUTCHES

IMPORTANT:



1. Reid™ Clutches/Lifting Eyes are manufactured in different sizes and ratings to match specific anchors. THE CORRECT CLUTCH MUST BE USED WITH THE CORRECT ANCHOR, i.e. 2.5t clutch with 2.5t anchor

2. When delivered to site, clutches must carry a current proof load test tag.

3. All clutches must be inspected for wear and tear before every lift.

3a. SwiftLift™ Clutches should be checked regularly to ensure they have not been damaged or that jaw opening H is not greater than H max shown in Table 4.2.1.

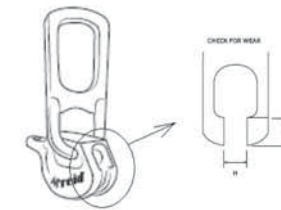

Table 4.2.1

Size (mm)	H max (mm)	M min (mm)
1.3	13	5.5
2.5	18	5.5
5.0	25	8.0
10.0	32	12.0
20.0	46	18.0
32.0	58	24.0

3b. JAWS™ Clutches should be checked regularly to make sure they have not been damaged or that the jaw opening J and the locking ring diameter P are as shown in Table 4.2.2. Ensure that the Locking Ring Arm is not removed.

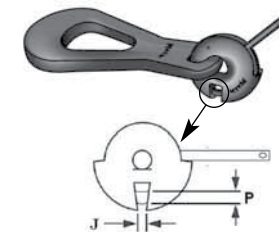

Table 4.2.2

Type	WLL (max)	J (mm)	P (mm)
SJHLC	7t	20	16
SJULC	10t	20	20

4.2.1 CLUTCH INSPECTION

Every Clutch or Lifting Eye is tested using the Reid Production Standard Operating Procedures. The following is an example of the test and traceability procedure:

1. Chemical Analysis

Every material batch

2. Unique Identification

All identified.

3. Dimensional Inspection

100% inspection

4. Visual Examination

Physical appearance and welds for defects

5. Xray Radiography

Tested by a NATA laboratory for internal voids

6. Hardness Testing

Every batch by heat treatment

7. Magnetic Particle Inspection

For surface defects and cracks

8. Proof Load

2 x WLL 100% of lifting eyes as per AS 3850 requirement.

9. Test Batch Identification

100% of Lifting Eye or clutch hard stamped with test batch number.

10. Release Inspection and Tagging

100% of lifting clutches to establish testing traceability and compliance to all above requirements.

4.2.2 TRACEABILITY

Reid maintain traceability of all the lifting eyes and clutches. Traceability is established by the unique sphere number and batch number to every one of the above tests and inspections. Records are maintained for every test and inspection and we retain all radiographs.

This is your guarantee of a quality and safe lifting product from Reid.

4.2.3 PROOF LOAD TEST REPORTS

Reid issues proof load test reports for lifting clutches from the initial in-service date. The initial service date is the later of:

- The date on the factory load test tag,
- If no tag is on the Lifting Eye or clutch then the Proof Load Test Report date, or
- The clutch, or lifting eye, invoice date from the authorised Reid reseller of the equipment.

Removal of the load test tag, field modifications or material damage to the clutch will render this certificate null and void. Certification of Reid clutches and lifting eyes extends only to clutches supplied directly to the end user by Reid, or official Reid distributor partners. Clutches or lifting eyes supplied by third party resellers are not covered by this certification, without written consent from Reid.

4.3 FACE LIFTING

4.3.1 SwiftLift™ FaceLift™ and EconoTilt™ Anchors

The SwiftLift™ Clutches have been exclusively designed and approved for use with Reid™ SwiftLift™ Anchors. They are available in a range of Working Load Limits. They have been designed so that they cannot spontaneously disengage whilst the system is under load at any orientation, provided they are installed correctly. When the lift is complete and the load released, the SwiftLift™ Clutch is quickly and simply disengaged. A special "remote release" SwiftLift™ Clutch is available for Tilt-up applications on SwiftLift™ FaceLifters™.

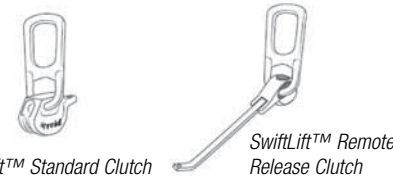

1. SwiftLift™ Clutch is attached to the SwiftLift™ anchor by lowering the clutch slot over the anchor head and rotating the clutch tab until it rests on the concrete surface.

NOTE: Tab MUST be on the side that will be uppermost when lifting.

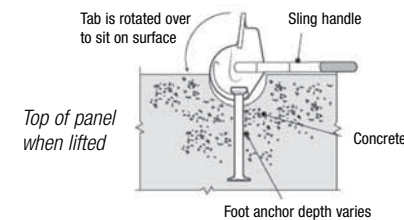

2. As the load is raised, the anchor takes the full tensile load.

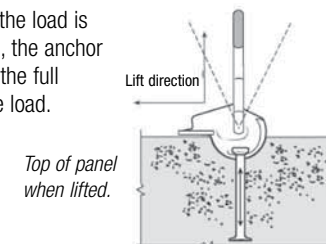

3. As the panel rotates to the vertical position, the clutch comes in contact with the concrete surface inside the void. This transfers the lifting force into the concrete and the anchor prevents the clutch from slipping out of the recess.

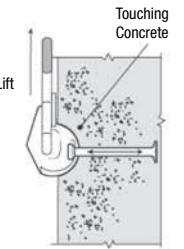

4. Lifting away from the tab is also safe provided the tab does not rise more than 30° from the concrete surface. If it does, lower to the ground and reset.

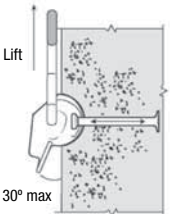

5. The SwiftLift™ Remote Release Clutch has an extended arm. This clutch is used with the SwiftLift™ FaceLifter™ which has a reduced void former to prevent rotation around the loop during disconnection. The Remote Release Arm allows disconnection to take place from the ground level with a Remote Release Rope. It is easily disconnected from the anchor head once the load has been removed.

N.B. - Disconnection is only possible when the load has been removed.

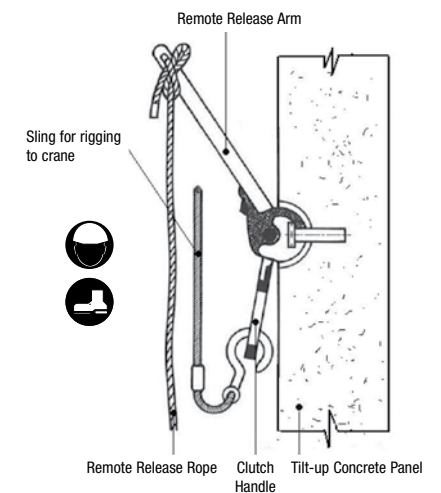

NOTE: It is always important to follow the standard rigging guidelines for concrete panels.

4.3.2 Ramset™ FaceLifter™ Anchors

The two types of clutches which can be used to lift the Ramset™ FaceLifter™ are the JAWS™ Heavy Clutch and the Ramset™ FaceLifter™ Hire Clutch. Both are a Lock Ring style lifting clutch. JAWS™ Heavy Clutch is readily available and the preferred clutch suited to the Ramset™ FaceLifter™.

It is attached to the FaceLifter™ by lowering the clutch slot over the plate anchor and rotating the locking ring arm until it rests on the concrete surface. The locking ring arm has a hole to allow for the attachment of a remote release rope.

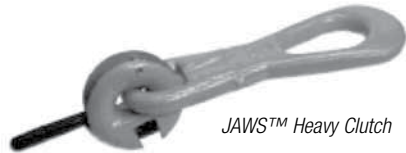

JAWS™ Heavy Clutch

1. Lower clutch slot over anchor.

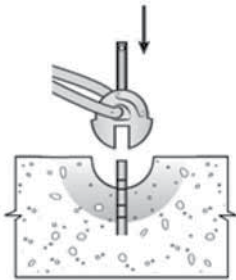

2. Rotate the locking ring arm until it rests on the concrete surface.

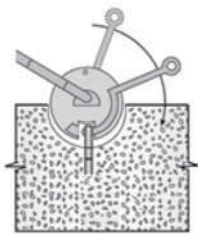

3. Before lifting, ensure clutch is FULLY engaged with the locking pin in full lock position.

NOTE: Locking Ring Arm MUST be on the side that will be uppermost when lifting.

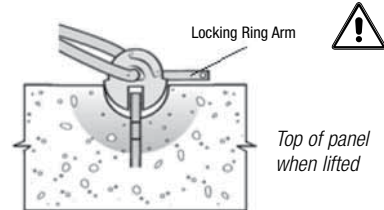

Top of panel when lifted

4. As the panel rotates to the vertical position, the clutch handle is positioned on top of the Locking Ring Arm.

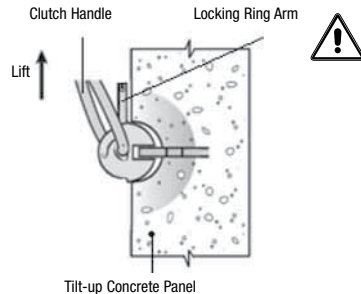

Tilt-up Concrete Panel

5. When the Precast Panel has been placed into its final position, disengaging the Locking Ring Arm can take place from the ground level with a Remote Release Rope.

N.B. - Disconnection is only possible when the load has been removed.

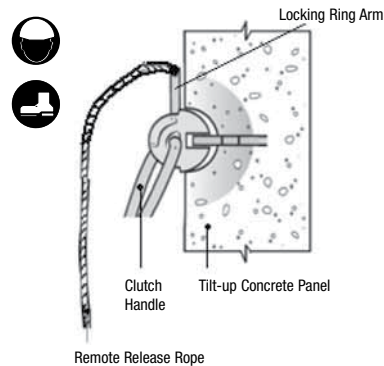

Remote Release Rope

4.4 EDGE LIFTING

4.4.1 SwiftLift™ JAWS™ Anchors



SJHLC and SJULC SwiftLift™ JAWS™ Lifting Clutch

SwiftLift™ JAWS™ Clutches are used to engage the SwiftLift™ JAWS™ Anchors to enable lifting of precast concrete panels. They are available in two load groups and are also colour coded to match the corresponding SwiftLift™ JAWS™ anchor and void former as follows;

Description	WLL (max)	Colour
Lite Lifting Clutch	3 Tonne	Green
Heavy Lifting Clutch	7 Tonne	Orange
Ultra Lifting Clutch	10 Tonne	Blue

JAWS™ SYSTEMS PART NUMBERS

	Ultra	Xtra	Heavy	Midi	Lite
Colour Code	Blue	Light Blue	Orange	Terracotta	Green
Anchor	SJU	SJX	SJH	SJM	SJL
Void Former	SJUVF	SJUVF	SJHVF	SJHVF	SJLVF
Support Plate	MFSP	MFSP	MFSP	MFSP	SJLSP
Clutch	SJULC	SJULC	SJHLC	SJHLC	SJLLC
Shearbar	SJURB	SJHRB	SJHRB	SJWRB	SJLRB

1. The SwiftLift™ JAWS™ Clutches are attached to the SwiftLift™ JAWS™ Anchor by lowering the clutch slot over the SwiftLift™ JAWS™ EdgeLift™ Anchor and rotating the locking ring arm until it rests on the concrete surface. The locking ring arm has a hole to allow for a remote release rope to be attached with a D-shackle.



DO NOT LIFT
Clutch is NOT engaged.

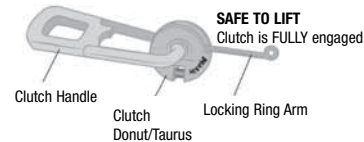

SAFE TO LIFT
Clutch is FULLY engaged.

Clutch Handle
Clutch Donut/Taurus
Locking Ring Arm

(A) Lower Clutch Slot over Anchor

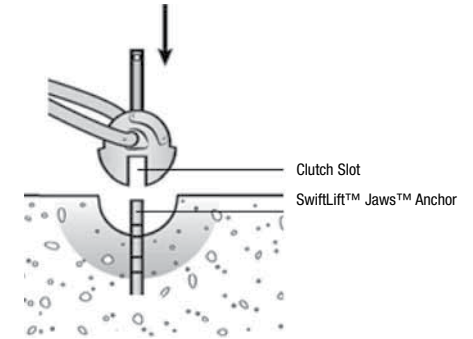

Clutch Slot
SwiftLift™ Jaws™ Anchor

(B) Rotating the Locking Ring Arm until it rests on the concrete surface

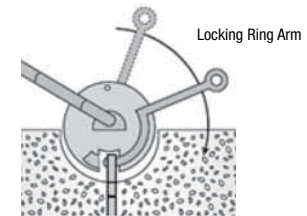

Locking Ring Arm

(C) Locking Ring Arm in the FULLY engaged position

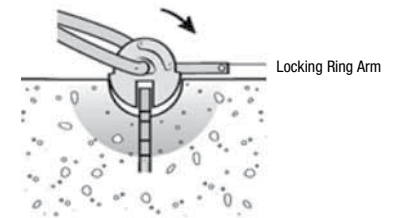

Locking Ring Arm

2. For edgelifting precast panels off the casting table/bed, the fully engaged SwiftLift™ JAWS™ Clutches are loaded in the direction shown in the diagram below.

EDGE LIFT

Void, Clutch and Anchor Relationship

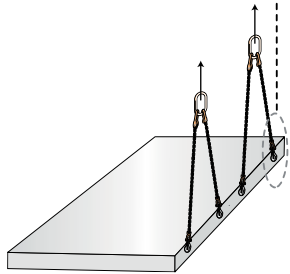
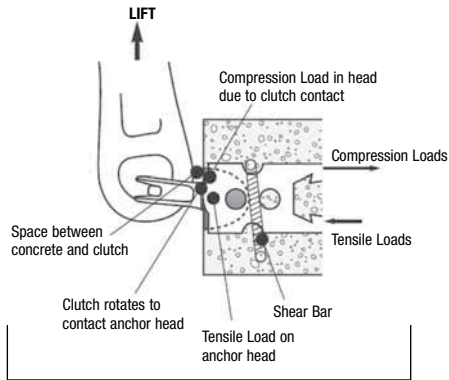

3. Once the precast panel has been fully lifted off the casting table/bed, the fully engaged SwiftLift™ JAWS™ Clutches are loaded as shown in the diagram below.

PARALLEL LIFT

Void, Clutch and Anchor Relationship

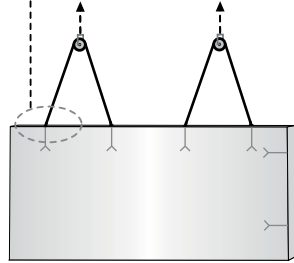
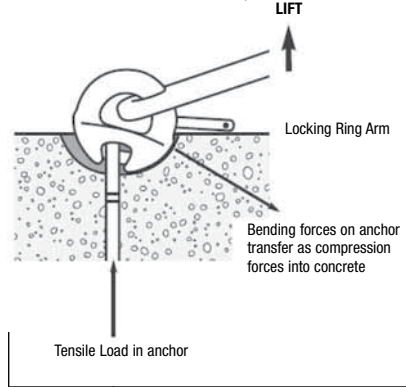

4.5 ROTATIONAL EDGELIFTING

4.5.1 Rigging Set-up

Many precast panels require a mid-air rotation so they can be positioned for final placement. An example of the rigging requirement for this is shown in the diagram to the right. (Note the position of the Locking Ring Arms).

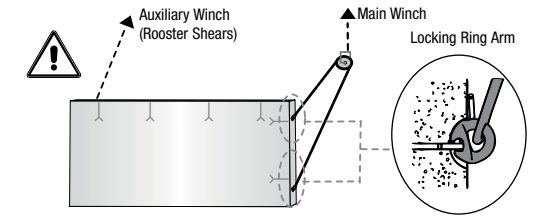

4.5.2 Initial lift

Depending on the lift design, up to 70% of the mass of the precast element can be taken by the tail lifter during rotation. The tail lifter is subjected to the highest applied load at the initial stages of the rotational lift as shown in the diagram to the right.

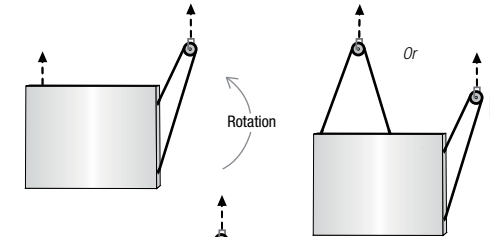

4.5.3 Mid-way through Rotation

As the panel is mid-way through the rotation, more and more load is transferred to the top pair of anchors and simultaneously less load is being applied on the tail lifter as shown in the diagram to the right.

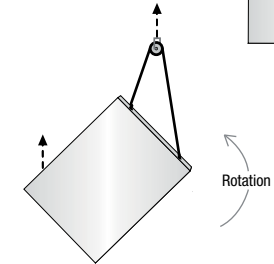

4.5.4 Position for Installation

When the precast panel is in its final position, the top pair of edgelifters are taking the entire load of the precast panel. The tail lifter is no longer required and the clutch is disengaged from this lifter. The panel is then ready for installation as shown in the diagram to the right.

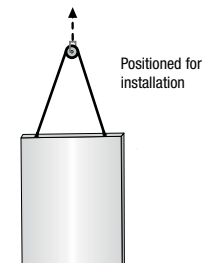

4.5.5 Remote Releasing

When the Precast Panel has been placed into its final position, disengaging the Locking Ring Arm can take place from the ground level with a Remote Release Rope. See diagram to the right.

N.B. - Disconnection is only possible when the load has been removed.

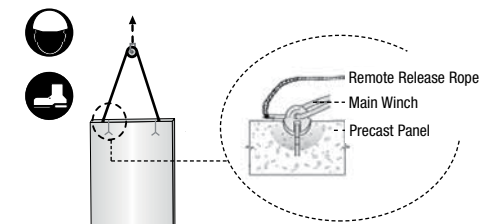

4.6 EFFECT OF SLING ANGLES

Sling angle effects need to be considered in the initial lift design stage. Whilst it is recommended to keep the sling angle under 60 degrees, any angle can be used as long as it was included in the initial anchor rating stage.

Always use the rigging design as specified by an appropriately qualified engineer to ensure the applied loads on anchors do not exceed their designed capacity.

NOTE:

1. THE SHORTER THE SLINGS, THE HIGHER THE LOAD ON THE ANCHORS.

For example, at an angle of 170° the load on each sling is six times the weight of the actual load being lifted.

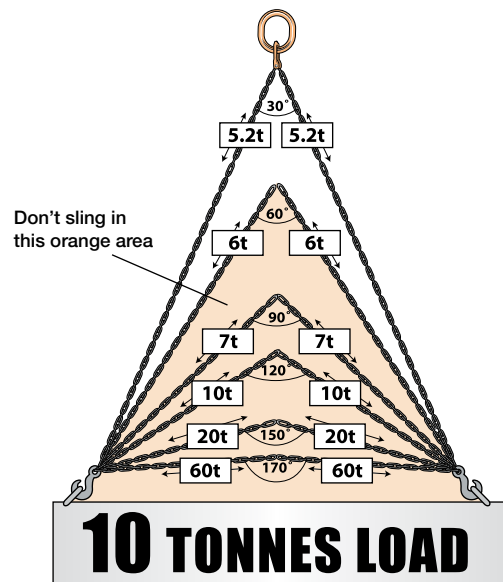

Never make sling length shorter than the distance between two anchors.

4.7 EFFECTIVE RIGGING

Using a spreader beam with two sets of chains will ensure the legs are equally loaded.

4.7.1 RECOMMENDED

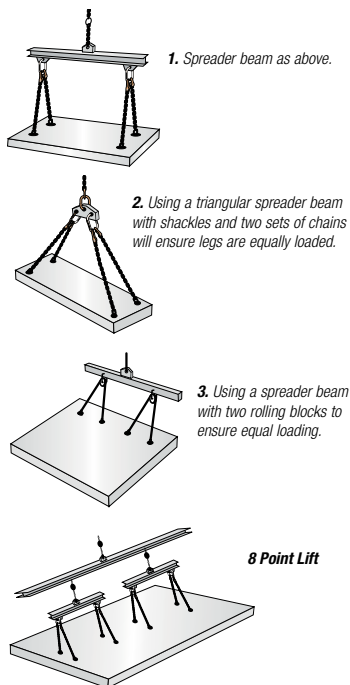

Other rigging details as per below diagrams:

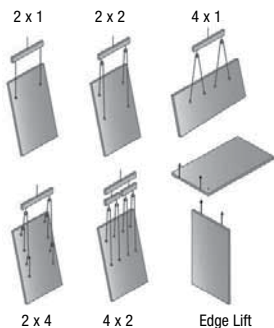

Minimum concrete strength at time of lift should be as per referenced shop drawings or lifting design drawings.

IMPORTANT:

Prior to lifting, slowly take up any slack in the lifting chains and slings. Check that all hooks are connected to the lifting clutches and that all lifting clutches are engaged to the lifting anchors. Ensure that load direction and sling angles are correct and that all rigging gear is free to move as the full load is applied.

Impact loads caused by sudden realignments of the load, excess slack in lifts and/or take up and movement of lifting machines over ground with load suspended can cause significantly increased loads on lifting equipment which under some conditions may exceed the capacity of anchors and cause failure.

4.8.2 TO BE AVOIDED

Uneven slings from a central lifting point. When lifting with four slings, any slight variation in sling lengths will cause the load to be shared between ONLY three slings NOT four, causing individual anchor and sling loads to increase significantly.

As a result you can potentially exceed the design capacity of the anchors and corresponding clutches.



4.9 STRONGBACKS

Strongbacks are used to provide additional stiffness to the concrete panel when its shape makes lifting too difficult using standard lift procedures.

NOTE:

- DESIGN AND LOCATION OF STRONGBACKS MUST BE CARRIED OUT BY A QUALIFIED ENGINEER.**
- IF A STRONGBACK IS TOO FLEXIBLE OR THE BOLTS ARE NOT LOCATED CORRECTLY, THE CONCRETE PANEL MAY STILL CRACK.**
- THE STRONGBACK/S MUST BE LOCATED TO ALLOW RIGGING TO OPERATE WITHOUT INTERFERENCE AT ALL ANGLES OF THE LIFT OPERATION.**
- DUE TO THEIR WEIGHT, CARE MUST BE TAKEN WHEN REMOVING STRONGBACKS. IF ALLOWED TO FALL OR SWING THEY CAN BE DANGEROUS AND DAMAGE PANELS AND EQUIPMENT.**

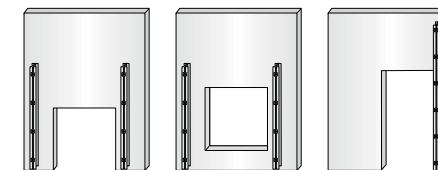

4.10 PIPE HANDLING

4.10.1 Sling Configuration

The sling is made up as a two-legged chain sling with two Reid™ SwiftLift™ Clutches and a shortening hook to enable one chain leg to be shortened. This allows for either symmetrical or asymmetrical lifting.

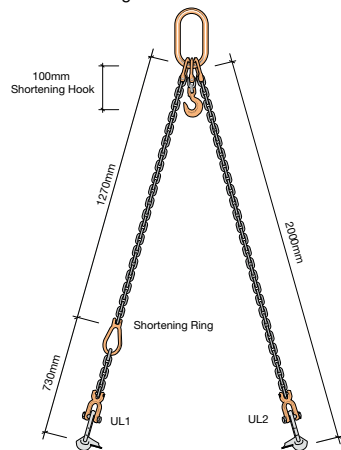

4.10.2 Transport, Lowering and Placing

The pipes are handled with the sling in its symmetrical mode and are lowered into the trench close to the last pipe laid.

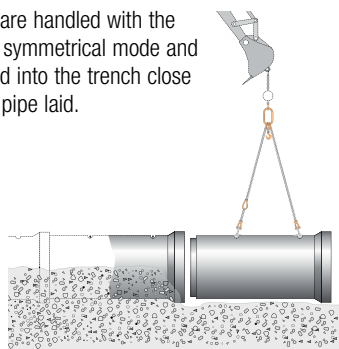

4.10.3 Jointing

The crane hook is lowered so that both slings become slack. This enables the sling to UL1 to be shortened by placing the shortening ring onto the shortening hook. UL2 is then disconnected from the pipe to be jointed and attached to the furthest anchor on the previously laid pipe.

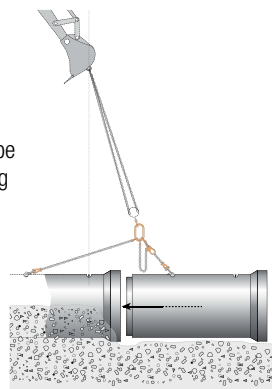

1. NEVER MAKE CHAIN LENGTH SHORTER THAN THE DISTANCE BETWEEN TWO ANCHORS

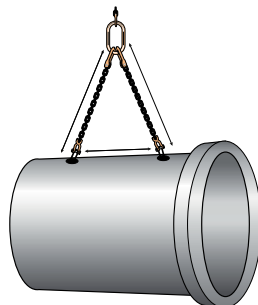

2. USE A SPREADER BETWEEN CHAINS TO AVOID DAMAGE TO CONCRETE ELEMENTS SUCH AS MANHOLE RISERS



5.1 RELEASING PANELS FROM CASTING BED

When lifting panels from the casting bed, it is very important not to overload the lifting anchors. Overloading can be caused by:

- Releasing agent not releasing properly.
- High “panel to bed” suction ratio.
- Incorrectly located anchors.
- Water or other liquid around the panel preventing air getting under the panel.
- Panels bouncing with sudden release causing shock loading.

To prevent overloading the anchors, the lift should be carried out as follows:

1. The crane takes up the slack of the rig and slowly increases the lifting force until the load on the anchors is only slightly above the force needed to lift the panel.
2. If the panel is not released, pry bars should be used to break the seal between the panel and casting bed. Do not apply loads at corner of panels.
3. Once the panel has been released it can be lifted as normal.

NOTE:
AVOID USING EXCESSIVE LIFTING FORCE AS THIS MAY CAUSE THE PANEL TO RELEASE SUDDENLY AND BOUNCE HARD DOWN ON THE ANCHORS WHICH MAY RESULT IN DAMAGE TO THE PANEL AND ANCHORS.

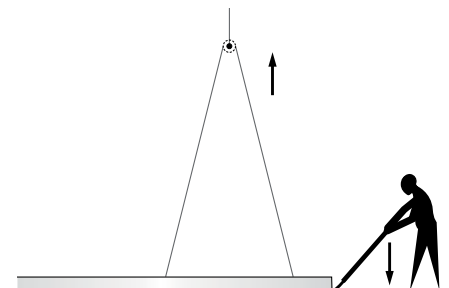

5.2 CONCRETE STRENGTH AND EDGE DISTANCE

Any concrete to which bracing will be fixed must have a minimum of 15MPa compressive strength at time of fixing.

Free edges must be treated with care to avoid damage and loss of support. It is recommended that the distance to any free edge be at least three times the anchor depth.

5.3 LIFTING

1. Prior to lifting, attach braces to panels to avoid putting workmen at risk on site



2. Use a small wheeled dolly under each brace foot to avoid damage to the concrete ground slab as the panel is lifted into place.

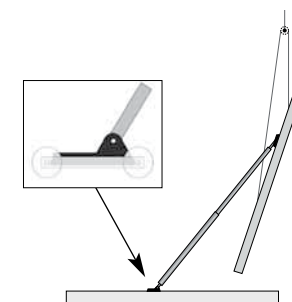

3. Pin the base of the panel using rebar or bolt a block to the concrete ground slab to provide a “stop” for the panel.

5.4 RE-USEABLE LIFTING EQUIPMENT

The only Australian Standard that is specific to precast concrete lifting systems (proprietary or non proprietary) is AS3850-2003, Tilt up Concrete Construction. Other Australian Standards refer to concrete construction in general and reinforcing for concrete but do not cover the use of these materials in their relevance to the lifting and handling of precast concrete elements.

AS3850-2003 requires a minimum Factor of Safety (FOS) of 2.5 on lifting inserts, with a higher minimum FOS on reusable lifting equipment (both subject to all reduction factors being at a minimum and complying with other conditions of the standard). The standard defines reusable lifting equipment as "A device that is directly connected to the lifting insert", and a lifting insert as "A component or system cast or fixed into the panel for later attachment of a lifting device".

Reid SwiftLift Foot Anchors are designed and manufactured not only in accordance with this Australian Standard, but also in consideration of other internationally recognised standards and codes of practice. Reid SwiftLift Foot Anchors also incorporate a higher minimum FOS of 3 on the minimum actual performance. This higher FOS ensures that the anchors will never be loaded above 40% of their yield strength when used within their rated Working Load Limit (WLL).

The principle factors that affect the reusability of Reid SwiftLift Foot anchors are:

- Overloading of the anchor past its WLL
- The condition of the concrete at time of lift
- Deformation of the anchor
- Corrosion of the anchor
- Other actions that have a physical impact on the anchor's materials properties or the anchor shape, i.e. welding to the anchor

Therefore, provided that the anchors have never been loaded past their WLL, that there is no physical deformation or corrosion of the anchor, that the concrete is still sound and in its original state, and that the loads are and have been applied at low speeds and at low frequency, they will continue to perform their design task repetitively.

Please note these comments relate only to the anchors themselves, and we point out that in these considerations the design of the concrete, anchor embedment and condition of the concrete also need to be assessed. For example an anchor rated at 10 tonne does not mean it has been installed in a manner that will safely carry 10 tonne.

5.5 Bracing

5.5.1 Reid Props

Reid props are high capacity steel props suitable for the positioning and temporarily stabilising of:

- Precast elements
- Retaining walls
- Tilt up panels
- Block walls
- Formwork

Panels can break or props fail if the bracing configuration is not right. These diagrams show the most common modes of failure.

Common modes of failure

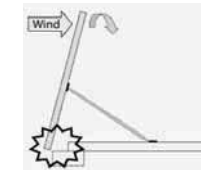

Bracing too low.
Foot of panel not confined

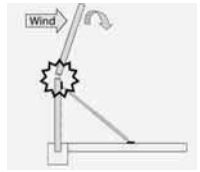

Too much unsupported panel
above brace point

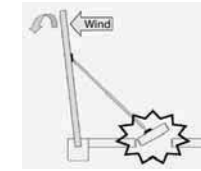

Support not strong enough to
carry load from wind.

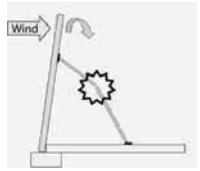

Props not strong enough

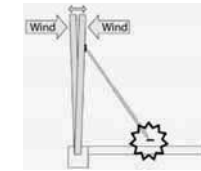

Bolt in footplate or panel plate
rattled loose by panel shake



Construction overload from traffic,
backfill, or another structure

5.5.2 SELECTING THE CORRECT PROP

The selection of prop length is made by taking into account the panel height, the load the prop must carry, and the position of the anchoring point on the ground. Ideally, the arrangement should be as below:



As a rule of thumb, a 3/4/5 triangle is a good installation configuration guideline.



Foot & Wall Bolting

Foot brace using a
BraceSet anchor, wall
brace using an anchored
ferrule

5.5.3 LIFTING PANEL & PROP

For safety it is best to attach the props to the panels prior to lifting.

Lift the panel carefully into place, the feet of the attached props will need to be lifted out as the panel is positioned to avoid scraping along the ground. Small dollies can be used for this.



Once the panel is placed in its correct position and approximately vertical, the feet of the props can be secured using suitable safety bolts and flat washers. As with the prop head, the foot plate must be secured with suitable safety bolts, and BraceSet anchors are recommended. Use the correct torque setting to ensure the anchor does not shake loose.



Once the foot of the prop is secure, the prop shaft is rotated to adjust its length to true panel.



Each panel must have at least two support props.

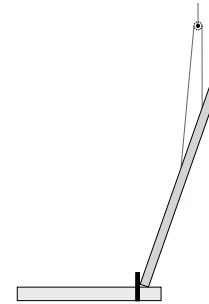

NOTE:

1. **DO NOT ATTACH TOP BRACE FOOT PLATES TO PANELS AFTER LIFT HAS OCCURRED.**
2. **BRACE FOOT BOLTS MUST BE TIGHTENED TO THE CORRECT TORQUE LEVEL TO ENSURE THE ANCHOR IS CORRECTLY SET.**
3. **CHECK TORQUE LEVELS OF BRACE FOOT BOLTS AFTER STRONG WINDS.**

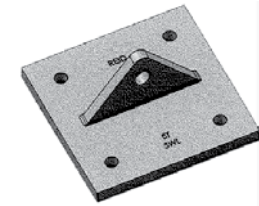

NOTE:

Lifting Plates can be used in instances where a lifting anchor has been overlooked or is missing. Requires 4 x BraceSet anchors.

The advice in this publication is of a general nature only. Where any doubt exists as to the safety of a particular installation or lift procedure, seek the guidance of a professional engineer, or phone Reid™ on:

1300 780 250

Your safety is our primary concern.

Don't Guess - ASK!!

Working With You Right From The Start

Right from the outset, you'll come to appreciate our singular focus on you and your business. Reid™ can provide the technical expertise and advice on all facets of Precast element lifting and bracing, as well as concrete connection and reinforcement. Our engineers can work with you from the start - all you do is supply your structural or shop drawings:

- Certified Lifting and Bracing Drawings that comply with all appropriate standards
 - On-site assistance anywhere in Australia
 - Over the phone technical support

Leading The Industry In Product Innovation & Safety

Our knowledge of the industry has enabled us to evolve into a company that is a leader in product innovation and service, with a singular focus on Tilt-up and Precast safety and efficiency. Many of our products are developed and produced in our Australian manufacturing plants. Raw material quality, x-ray testing, surface hardness testing, and proof load testing are just some of the stringent safeguards we undertake to ensure products that carry the Reid™ brand are the very best on the market.

It's this focus that lifts the responsibility off your shoulders... Reid™, partnering you and your business.

Customer Service Centre
1300 780 250
www.reid.com.au

ITW Construction Systems Australia Pty. Ltd. ABN 48 004 297 009 Trading as Reid™.

™Trademarks of ITW Construction Systems Australia Pty. Ltd. ™Ramset is a trademark of Cetram Pty. Ltd.

*Conditions apply © Copyright 2010 WPAUG11. All information contained in this document is correct at time of printing but is subject to change without notice.



REINFORCING • PRECAST • TILT-UP