

# Atlas Copco Instruction Manual



Instruction Manual  
for AC Generators  
English

**QES 60 Jd S3A ESF**

**QES 85 Jd S3A ESF**

**QES 105 Jd S3A ESF**

**QES 120 Jd S3A ESF**

**QES 150 Jd S3A ESF**

**QES 200 Jd S3A ESF**

4045HFG81

4045HFG82\_A

4045HFG82\_B

4045HFG82\_C

6068HFG82\_A

6068HFG82\_B

*Atlas Copco*



**QES 60-85-105-120-150-200 Jd S3 ESF**

**Instruction Manual for AC Generators**

Instruction manual ..... 5

Circuit diagrams ..... 109

**Original instructions**

Printed matter N°  
2954 91 G 00

10/2016



---

ATLAS COPCO - PORTABLE ENERGY DIVISION  
[www.atlascopco.com](http://www.atlascopco.com)

---

### **Warranty and Liability Limitation**

Use only authorized parts.

Any damage or malfunction caused by the use of unauthorized parts is not covered by Warranty or Product Liability.

The manufacturer does not accept any liability for any damage arising from modifications, additions or conversions made without the manufacturer's approval in writing.

Neglecting maintenance or making changes to the setup of the machine can result in major hazards, including fire risk.

While every effort has been made to ensure that the information in this manual is correct, Atlas Copco does not assume responsibility for possible errors.

Copyright 2016, Grupos Electrógenos Europa, S.A.U., Zaragoza, Spain.

Any unauthorized use or copying of the contents or any part thereof is prohibited.

This applies in particular to trademarks, model denominations, part numbers and drawings.



*Congratulations on the purchase of your QES generator set. It is a solid, safe and reliable machine, built according to the latest technology. Follow the instructions in this booklet and we guarantee you years of trouble free operation. Please read the following instructions carefully before starting to use your machine. While every effort has been made to ensure that the information in this manual is correct, Atlas Copco does not assume responsibility for possible errors. Atlas Copco reserves the right to make changes without prior notice.*

## Contents

<b>1</b>	<b>Safety precautions for on-site generator sets..... 8</b>	2.3.9	Spillage free skid..... 19	<b>4.2</b>	<b>Operating and setting Qc1111™/Qc2111™ .....25</b>
<b>1.1</b>	<b>Introduction..... 8</b>	2.3.10	Hot parts protection (CE compliance) ..... 19	4.2.1	Setting the Qc1111™/Qc2111™.....25
<b>1.2</b>	<b>General safety precautions..... 9</b>	<b>2.4</b>	<b>Electrical features.....20</b>	4.2.1.1	Button overview .....25
<b>1.3</b>	<b>Safety during transport and installation..... 11</b>	2.4.1	Emergency stop.....20	4.2.1.2	LED overview.....26
<b>1.4</b>	<b>Safety during use and operation ..... 11</b>	2.4.2	Qc1111™/Qc2111™ control module.....20	4.2.1.3	Graphical display.....26
<b>1.5</b>	<b>Safety during maintenance and repair..... 12</b>	2.4.3	Output terminal board .....21	4.2.1.4	Qc1111™/Qc2111™ menu overview.....29
<b>1.6</b>	<b>Tool applications safety ..... 14</b>	2.4.4	Earth leakage relay.....21	4.2.2	Generator set operating modes.....33
<b>1.7</b>	<b>Battery safety precautions..... 14</b>	<b>3</b>	<b>Installation and connection .....22</b>	4.2.2.1	Stop mode .....33
<b>2</b>	<b>Main parts ..... 15</b>	<b>3.1</b>	<b>Lifting .....22</b>	4.2.2.2	Auto mode / Mains failure .....34
<b>2.1</b>	<b>General description ..... 15</b>	<b>3.2</b>	<b>Installation .....22</b>	4.2.2.3	Manual mode.....35
<b>2.2</b>	<b>Markings ..... 17</b>	3.2.1	Indoor installation .....22	4.2.3	Front panel configuration.....36
<b>2.3</b>	<b>Mechanical features..... 18</b>	3.2.2	Outdoor installation .....22	<b>5</b>	<b>Maintenance ..... 38</b>
2.3.1	Engine and alternator ..... 18	<b>3.3</b>	<b>Connecting the generator set.....23</b>	<b>5.1</b>	<b>Maintenance schedule.....38</b>
2.3.2	Cooling system..... 18	3.3.1	Precautions for non-linear and sensitive loads.....23	5.1.1	Use of maintenance schedule .....42
2.3.3	Safety devices ..... 18	3.3.2	Quality, minimum section and maximum length of cables.....23	5.1.2	Use of service packs.....42
2.3.4	Bodywork..... 18	3.3.3	Connecting the load .....24	<b>5.2</b>	<b>Preventing low loads .....43</b>
2.3.5	Control panel ..... 18	<b>4</b>	<b>Operating instructions .....25</b>	5.2.1	General.....43
2.3.6	Data plate and serial number..... 18	<b>4.1</b>	<b>Before starting.....25</b>	5.2.2	Risks of low load operation .....43
2.3.7	Drain plugs and filler caps..... 18			5.2.3	Best practices.....43
2.3.8	Rustproof plastic fuel tank..... 18				

<b>5.3</b>	<b>Alternator maintenance procedures</b> .....	<b>44</b>	5.5.2.1	Checking belt wear.....	51	<b>8</b>	<b>Disposal</b> .....	<b>70</b>
5.3.1	Measuring the alternator insulation resistance.....	44	5.5.2.2	Checking tensioner spring tension.....	52	<b>8.1</b>	<b>General</b> .....	<b>70</b>
<b>5.4</b>	<b>Engine maintenance procedures</b> .....	<b>44</b>	5.5.2.3	Replacing fan and alternator belts.....	52	<b>8.2</b>	<b>Disposal of materials</b> .....	<b>70</b>
5.4.1	Engine oil level check.....	44	5.5.3	Measuring the valve clearance.....	53	<b>9</b>	<b>Options available</b> .....	<b>71</b>
5.4.2	Engine oil and oil filter change.....	45	<b>5.6</b>	<b>Engine consumable specifications</b> .....	<b>54</b>	<b>9.1</b>	<b>Circuit diagrams</b> .....	<b>71</b>
5.4.3	Coolant check.....	46	5.6.1	Engine fuel specifications.....	54	<b>9.2</b>	<b>Overview of the electrical options</b> .....	<b>71</b>
5.4.3.1	Monitoring coolant condition.....	46	5.6.2	Engine oil specifications.....	54	<b>9.3</b>	<b>Description of the electrical options</b> .....	<b>71</b>
5.4.3.2	Topping up of coolant.....	46	5.6.3	Engine coolant specifications.....	55	9.3.1	Automatic battery charger.....	71
5.4.3.3	Replacing the coolant.....	47	<b>6</b>	<b>Checks and trouble shooting</b> .....	<b>57</b>	9.3.2	Battery switch.....	72
5.4.4	Air filter check.....	47	<b>6.1</b>	<b>Engine troubleshooting</b> .....	<b>57</b>	9.3.3	Engine coolant heater.....	72
5.4.4.1	Main parts.....	47	<b>6.2</b>	<b>Alternator troubleshooting</b> .....	<b>60</b>	9.3.4	Air heater for cold start.....	72
5.4.4.2	Recommendation.....	48	<b>6.3</b>	<b>Solving Qc1111™/Qc2111™ controller alarms</b> .....	<b>61</b>	9.3.5	Outlet sockets (S) - 3-phase.....	73
5.4.4.3	Cleaning the dust trap.....	48	6.3.1	Qc1111™/Qc2111™ alarms and remedies.....	61	9.3.6	Dual frequency.....	74
5.4.4.4	Replacing the air filter element.....	48	6.3.2	Alarm overview.....	62	9.3.7	IT-relay.....	75
5.4.5	Replacing fuel filter.....	48	6.3.2.1	Warning alarm icons.....	62	<b>9.4</b>	<b>Overview of the mechanical options</b> .....	<b>76</b>
5.4.6	Bleeding the fuel system.....	49	6.3.2.2	Electrical trip alarm icons.....	65	<b>9.5</b>	<b>Description of the mechanical options</b> .....	<b>76</b>
<b>5.5</b>	<b>Adjustments and service procedures</b> .....	<b>50</b>	6.3.2.3	Shutdown alarm icons.....	66	9.5.1	External fuel tank connection (with/without quick couplings).....	76
5.5.1	Battery care.....	50	<b>7</b>	<b>Storage of the generator set</b> .....	<b>69</b>	9.5.2	Oil drain pump.....	77
5.5.1.1	Electrolyte.....	50	<b>7.1</b>	<b>Storage</b> .....	<b>69</b>	9.5.3	Undercarriage (axle, towbar, towing eyes).....	77
5.5.1.2	Activating a dry-charged battery.....	50	<b>7.2</b>	<b>Preparing for operation after storage</b> .....	<b>69</b>	9.5.4	Skid frame.....	77
5.5.1.3	Recharging a battery.....	50						
5.5.1.4	Make-up distilled water.....	51						
5.5.1.5	Periodic battery service.....	51						
5.5.2	Checking belt tensioner spring tension and belt wear.....	51						

<b>10</b>	<b>Technical specifications .....</b>	<b>78</b>
<b>10.1</b>	<b>Technical specifications for QES 60 units .....</b>	<b>78</b>
<b>10.2</b>	<b>Technical specifications for QES 85.....</b>	<b>82</b>
<b>10.3</b>	<b>Technical specifications for QES 105 units.....</b>	<b>87</b>
<b>10.4</b>	<b>Technical specifications for QES 120 units.....</b>	<b>92</b>
<b>10.5</b>	<b>Technical specifications for QES 150 units.....</b>	<b>97</b>
<b>10.6</b>	<b>Technical specifications for QES 200 units.....</b>	<b>102</b>
<b>10.7</b>	<b>Critical bolt connections - torque values.....</b>	<b>107</b>
<b>10.8</b>	<b>Conversion list of SI units into British units .....</b>	<b>108</b>
<b>10.9</b>	<b>Data plate .....</b>	<b>108</b>

# 1 Safety precautions for on-site generator sets

To be read attentively and acted accordingly before towing, lifting, operating, performing maintenance or repairing the generator set.

## 1.1 Introduction

The policy of Atlas Copco is to provide the users of their equipment with safe, reliable and efficient products. Factors taken into account are among others:

- the intended and predictable future use of the products, and the environments in which they are expected to operate,
- applicable rules, codes and regulations,
- the expected useful product life, assuming proper service and maintenance,
- providing the manual with up-to-date information.

Before handling any product, take time to read the relevant instruction manual. Besides giving detailed operating instructions, it also gives specific information about safety, preventive maintenance, etc.

Keep the manual always at the unit location, easy accessible to the operating personnel.

See also the safety precautions of the engine and possible other equipment, which are separately sent along or are mentioned on the equipment or parts of the unit.

These safety precautions are general and some statements will therefore not always apply to a particular unit.

Only people that have the right skills should be allowed to operate, adjust, perform maintenance or repair on Atlas Copco equipment. It is the responsibility of management to appoint operators with the appropriate training and skill for each category of job.

### **Skill level 1: Operator**

An operator is trained in all aspects of operating the unit with the push-buttons, and is trained to know the safety aspects.

### **Skill level 2: Mechanical technician**

A mechanical technician is trained to operate the unit the same as the operator. In addition, the mechanical technician is also trained to perform maintenance and repair, as described in the instruction manual, and is allowed to change settings of the control and safety system. A mechanical technician does not work on live electrical components.

### **Skill level 3: Electrical technician**

An electrical technician is trained and has the same qualifications as both the operator and the mechanical technician. In addition, the electrical technician may carry out electrical repairs within the various enclosures of the unit. This includes work on live electrical components.

### **Skill level 4: Specialist from the manufacturer**

This is a skilled specialist sent by the manufacturer or its agent to perform complex repairs or modifications to the equipment.

In general it is recommended that not more than two people operate the unit, more operators could lead to unsafe operating conditions. Take necessary steps to keep unauthorized persons away from the unit and eliminate all possible sources of danger at the unit.

When handling, operating, overhauling and/or performing maintenance or repair on Atlas Copco equipment, the mechanics are expected to use safe engineering practices and to observe all relevant local safety requirements and ordinances. The following list is a reminder of special safety directives and precautions mainly applicable to Atlas Copco equipment.

Neglecting the safety precautions may endanger people as well as environment and machinery:

- endanger people due to electrical, mechanical or chemical influences,
- endanger the environment due to leakage of oil, solvents or other substances,
- endanger the machinery due to function failures.

All responsibility for any damage or injury resulting from neglecting these precautions or by non-observance of ordinary caution and due care required in handling, operating, maintenance or repair, also if not expressly mentioned in this instruction manual, is disclaimed by Atlas Copco.



The manufacturer does not accept any liability for any damage arising from the use of non-original parts and for modifications, additions or conversions made without the manufacturer's approval in writing.

If any statement in this manual does not comply with local legislation, the stricter of the two shall be applied.

Statements in these safety precautions should not be interpreted as suggestions, recommendations or inducements that it should be used in violation of any applicable laws or regulations.

## 1.2 General safety precautions

- 1 The owner is responsible for maintaining the unit in a safe operating condition. Unit parts and accessories must be replaced if missing or unsuitable for safe operation.
- 2 The supervisor, or the responsible person, shall at all times make sure that all instructions regarding machinery and equipment operation and maintenance are strictly followed and that the machines with all accessories and safety devices, as well as the consuming devices, are in good repair, free of abnormal wear or abuse, and are not tampered with.
- 3 Whenever there is an indication or any suspicion that an internal part of a machine is overheated, the machine shall be stopped but no inspection covers shall be opened before sufficient cooling time has elapsed; this to avoid the risk of spontaneous ignition of oil vapour when air is admitted.
- 4 Normal ratings (pressures, temperatures, speeds, etc.) shall be durably marked.
- 5 Operate the unit only for the intended purpose and within its rated limits (pressure, temperature, speeds, etc.).
- 6 The machinery and equipment shall be kept clean, i.e. as free as possible from oil, dust or other deposits.
- 7 To prevent an increase in working temperature, inspect and clean heat transfer surfaces (cooler fins, intercoolers, water jackets, etc.) regularly. See the maintenance schedule.
- 8 All regulating and safety devices shall be maintained with due care to ensure that they function properly. They may not be put out of action.
- 9 Pressure and temperature gauges shall be checked regularly with regard to their accuracy. They shall be replaced whenever outside acceptable tolerances.
- 10 Safety devices shall be tested as described in the maintenance schedule of the instruction manual to determine that they are in good operating condition.
- 11 Mind the markings and information labels on the unit.
- 12 In the event the safety labels are damaged or destroyed, they must be replaced to ensure operator safety.
- 13 Keep the work area neat. Lack of order will increase the risk of accidents.

14 When working on the unit, wear safety clothing. Depending on the kind of activities these are: safety glasses, ear protection, safety helmet (including visor), safety gloves, protective clothing, safety shoes. Do not wear the hair long and loose (protect long hair with a hairnet), or wear loose clothing or jewellery.

15 Take precautions against fire. Handle fuel, oil and anti-freeze with care because they are inflammable substances. Do not smoke or approach with naked flame when handling such substances. Keep a fire-extinguisher in the vicinity.

### 16a On-site generator sets (with earthing pin):

Earth the generator set as well as the load properly.

### 16b On-site generator sets IT:

**Note:** This generator set is built to supply a sheer alternating current IT network.  
Earth the load properly.

### **1.3 Safety during transport and installation**

To lift a unit, all loose or pivoting parts, e.g. doors and towbar, shall first be securely fastened.

Do not attach cables, chains or ropes directly to the lifting eye; apply a crane hook or lifting shackle meeting local safety regulations. Never allow sharp bends in lifting cables, chains or ropes.

Helicopter lifting is not allowed.

It is strictly forbidden to dwell or stay in the risk zone under a lifted load. Never lift the unit over people or residential areas. Lifting acceleration and deceleration shall be kept within safe limits.

#### 1 Before towing the unit:

- check the towbar, the brake system and the towing eye. Also check the coupling of the towing vehicle,
- check the towing and brake capability of the towing vehicle,
- check that the towbar, jockey wheel or stand leg is safely locked in the raised position,
- ascertain that the towing eye can swivel freely on the hook,
- check that the wheels are secure and that the tyres are in good condition and inflated correctly,
- connect the signalisation cable, check all lights and connect the pneumatic brake couplers,
- attach the safety break-away cable or safety chain to the towing vehicle,
- remove wheel chocks, if applied, and disengage the parking brake.

#### 2 To tow a unit use a towing vehicle of ample capacity. Refer to the documentation of the towing vehicle.

3 If a unit is to be backed up by a towing vehicle, disengage the overrun brake mechanism (if it is not an automatic mechanism).

4 In case of transporting a non-trailer unit on a truck, fasten it to the truck by attaching straps via fork lift slots, via the holes in the frame at the front and back or via the lifting beam. To prevent damage, never put straps on the roof surface of the unit.

5 Never exceed the maximum towing speed of the unit (mind the local regulations).

6 Place the unit on level ground and apply the parking brake before disconnecting the unit from the towing vehicle. Unclip the safety break-away cable or safety chain. If the unit has no parking brake or jockey wheel, immobilize the unit by placing chocks in front of and/or behind the wheels. When the towbar can be positioned vertically, the locking device must be applied and kept in good order.

7 To lift heavy parts, a hoist of ample capacity, tested and approved according to local safety regulations, shall be used.

8 Lifting hooks, eyes, shackles, etc., shall never be bent and shall only have stress in line with their design load axis. The capacity of a lifting device diminishes when the lifting force is applied at an angle to its load axis.

9 For maximum safety and efficiency of the lifting apparatus all lifting members shall be applied as near to perpendicular as possible. If required, a lifting beam shall be applied between hoist and load.

10 Never leave a load hanging on a hoist.

11 A hoist has to be installed in such a way that the object will be lifted perpendicular. If that is not possible, the necessary precautions must be taken to prevent load-swinging, e.g. by using two hoists, each at approximately the same angle not exceeding 30° from the vertical.

12 Locate the unit away from walls. Take all precautions to ensure that hot air exhausted from the engine and driven machine cooling systems cannot be recirculated. If such hot air is taken in by the engine or driven machine cooling fan, this may cause overheating of the unit; if taken in for combustion, the engine power will be reduced.

13 Generator sets shall be stalled on an even, solid floor, in a clean location with sufficient ventilation. If the floor is not level or can vary in inclination, consult Atlas Copco.

14 The electrical connections shall correspond to local codes. The machines shall be earthed and protected against short circuits by fuses or circuit breakers.

15 Never connect the generator set outlets to an installation which is also connected to a public mains.

16 Before connecting a load, switch off the corresponding circuit breaker, and check whether frequency, voltage, current and power factor comply with the ratings of the generator set.

17 Before transportation of the unit, switch off all the circuit breakers.

## 1.4 Safety during use and operation

- 1 When the unit has to operate in a fire-hazardous environment, each engine exhaust has to be provided with a spark arrester to trap incendiary sparks.
- 2 The exhaust contains carbon monoxide which is a lethal gas. When the unit is used in a confined space, conduct the engine exhaust to the outside atmosphere by a pipe of sufficient diameter; do this in such a way that no extra back pressure is created for the engine. If necessary, install an extractor. Observe any existing local regulations.

Make sure that the unit has sufficient air intake for operation. If necessary, install extra air intake ducts.
- 3 When operating in a dust-laden atmosphere, place the unit so that dust is not carried towards it by the wind. Operation in clean surroundings considerably extends the intervals for cleaning the air intake filters and the cores of the coolers.
- 4 Never remove a filler cap of the cooling water system of a hot engine. Wait until the engine has sufficiently cooled down.
- 5 Never refill fuel while the unit is running, unless otherwise stated in the Atlas Copco Instruction Book (AIB). Keep fuel away from hot parts such as air outlet pipes or the engine exhaust. Do not smoke when fuelling. When fuelling from an automatic pump, an earthing cable should be connected to the unit to discharge static electricity. Never spill nor leave oil, fuel, coolant or cleansing agent in or around the unit.
- 6 All doors shall be shut during operation so as not to disturb the cooling air flow inside the bodywork and/or render the silencing less effective. A door should be kept open for a short period only e.g. for inspection or adjustment.
- 7 Periodically carry out maintenance works according to the maintenance schedule.
- 8 Stationary housing guards are provided on all rotating or reciprocating parts not otherwise protected and which may be hazardous to personnel. Machinery shall never be put into operation, when such guards have been removed, before the guards are securely reinstalled.
- 9 Noise, even at reasonable levels, can cause irritation and disturbance which, over a long period of time, may cause severe injuries to the nervous system of human beings.

When the sound pressure level, at any point where personnel normally has to attend, is:

  - below 70 dB(A): no action needs to be taken,
  - above 70 dB(A): noise-protective devices should be provided for people continuously being present in the room,
  - below 85 dB(A): no action needs to be taken for occasional visitors staying a limited time only,
  - above 85 dB(A): room to be classified as a noise-hazardous area and an obvious warning shall be placed permanently at each entrance to alert people entering the room, for even relatively short times, about the need to wear ear protectors,
  - above 95 dB(A): the warning(s) at the entrance(s) shall be completed with the recommendation that also occasional visitors shall wear ear protectors,
- above 105 dB(A): special ear protectors that are adequate for this noise level and the spectral composition of the noise shall be provided and a special warning to that effect shall be placed at each entrance.
- 10 The unit has parts of which the temperature can be in excess of 80 °C (176 °F), and which may be accidentally touched by personnel when opening the machine during or just after operation. Insulation or safety guards protecting these parts shall not be removed before the parts have cooled down sufficiently, and must be re-installed before operating the machine. As it is not possible to insulate or protect all hot parts by guards (e.g. exhaust manifold, exhaust turbine), the operator / service engineer must always be aware not to touch hot parts when opening a machine door.
- 11 Never operate the unit in surroundings where there is a possibility of taking in flammable or toxic fumes.
- 12 If the working process produces fumes, dust or vibration hazards, etc., take the necessary steps to eliminate the risk of personnel injury.
- 13 When using compressed air or inert gas to clean down equipment, do so with caution and use the appropriate protection, at least safety glasses, for the operator as well as for any bystander. Do not apply compressed air or inert gas to your skin or direct an air or gas stream at people. Never use it to clean dirt from your clothes.
- 14 When washing parts in or with a cleaning solvent, provide the required ventilation and use appropriate protection such as a breathing filter, safety glasses, rubber apron and gloves, etc.

- 15 Safety shoes should be compulsory in any workshop and if there is a risk, however small, of falling objects, wearing of a safety helmet should be included.
- 16 If there is a risk of inhaling hazardous gases, fumes or dust, the respiratory organs must be protected and depending on the nature of the hazard, so must the eyes and skin.
- 17 Remember that where there is visible dust, the finer, invisible particles will almost certainly be present too; but the fact that no dust can be seen is not a reliable indication that dangerous, invisible dust is not present in the air.
- 18 Never operate the generator set in excess of its limits as indicated in the technical specifications and avoid long no-load sequences.
- 19 Never operate the generator set in a humid atmosphere. Excessive moisture reduces the generator set insulation.
- 20 Do not open electrical cabinets, cubicles or other equipment while voltage is supplied. If such cannot be avoided, e.g. for measurements, tests or adjustments, have the action carried out by a qualified electrician only, with appropriate tools, and ascertain that the required bodily protection against electrical hazards is applied.
- 21 Never touch the power terminals during operation of the machine.
- 22 Whenever an abnormal condition arises, e.g. excessive vibration, noise, odour, etc., switch the circuit breakers to OFF and stop the engine. Correct the faulty condition before restarting.
- 23 Check the electric cables regularly. Damaged cables and insufficient tightening of connections may cause electric shocks. Whenever damaged wires or dangerous conditions are observed, switch the circuit breakers to OFF and stop the engine. Replace the damaged wires or correct the dangerous condition before restarting. Make sure that all electric connections are securely tightened.
- 24 Avoid overloading the generator set. The generator set is provided with circuit breakers for overload protection. When a breaker has tripped, reduce the concerned load before restarting.
- 25 If the generator set is used as stand-by for the mains supply, it must not be operated without control system which automatically disconnects the generator set from the mains when the mains supply is restored.
- 26 Never remove the cover of the output terminals during operation. Before connecting or disconnecting wires, switch off the load and the circuit breakers, stop the machine and make sure that the machine cannot be started inadvertently or there is any residual voltage on the power circuit.
- 27 Running the generator set at low load for long periods will reduce the lifetime of the engine.
- 28 When operating the generator set in Remote or Auto mode, observe all relevant local legislation.

## **1.5 Safety during maintenance and repair**

Maintenance, overhaul and repair work shall only be carried out by adequately trained personnel; if required, under supervision of someone qualified for the job.

- 1 Use only the correct tools for maintenance and repair work, and only tools which are in good condition.
- 2 Parts shall only be replaced by genuine Atlas Copco replacement parts.
- 3 All maintenance work, other than routine attention, shall only be undertaken when the unit is stopped. Steps shall be taken to prevent inadvertent starting. In addition, a warning sign bearing a legend such as “work in progress; do not start” shall be attached to the starting equipment.  
On engine-driven units the battery shall be disconnected and removed or the terminals covered by insulating caps.  
On electrically driven units the main switch shall be locked in open position and the fuses shall be taken out. A warning sign bearing a legend such as “work in progress; do not supply voltage” shall be attached to the fuse box or main switch.
- 4 Prior to stripping an engine or other machine or undertaking major overhaul on it, prevent all movable parts from rolling over or moving.

- 5 Make sure that no tools, loose parts or rags are left in or on the machine. Never leave rags or loose clothing near the engine air intake.
- 6 Never use flammable solvents for cleaning (fire-risk).
- 7 Take safety precautions against toxic vapours of cleaning liquids.
- 8 Never use machine parts as a climbing aid.
- 9 Observe scrupulous cleanliness during maintenance and repair. Keep away dirt, cover the parts and exposed openings with a clean cloth, paper or tape.
- 10 Never weld on or perform any operation involving heat near the fuel or oil systems. Fuel and oil tanks must be completely purged, e.g. by steam-cleaning, before carrying out such operations. Never weld on, or in any way modify, pressure vessels. Disconnect the alternator cables during arc welding on the unit.
- 11 Support the towbar and the axle(s) securely if working underneath the unit or when removing a wheel. Do not rely on jacks.
- 12 Do not remove any of, or tamper with, the sound-damping material. Keep the material free of dirt and liquids such as fuel, oil and cleansing agents. If any sound-damping material is damaged, replace it to prevent the sound pressure level from increasing.
- 13 Use only lubricating oils and greases recommended or approved by Atlas Copco or the machine manufacturer. Ascertain that the selected lubricants comply with all applicable safety regulations, especially with regard to explosion or fire-risk and the possibility of decomposition or generation of hazardous gases. Never mix synthetic with mineral oil.
- 14 Protect the engine, alternator, air intake filter, electrical and regulating components, etc., to prevent moisture ingress, e.g. when steam-cleaning.
- 15 When performing any operation involving heat, flames or sparks on a machine, the surrounding components shall first be screened with non-flammable material.
- 16 Never use a light source with open flame for inspecting the interior of a machine.
- 17 When repair has been completed, the machine shall be barred over at least one revolution for reciprocating machines, several revolutions for rotary ones to ensure that there is no mechanical interference within the machine or driver. Check the direction of rotation of electric motors when starting up the machine initially and after any alteration to the electrical connection(s) or switch gear, to check that the oil pump and the fan function properly.
- 18 Maintenance and repair work should be recorded in an operator's logbook for all machinery. Frequency and nature of repairs can reveal unsafe conditions.
- 19 When hot parts have to be handled, e.g. shrink fitting, special heat-resistant gloves shall be used and, if required, other body protection shall be applied.
- 20 When using cartridge type breathing filter equipment, ascertain that the correct type of cartridge is used and that its useful service life is not surpassed.
- 21 Make sure that oil, solvents and other substances likely to pollute the environment are properly disposed of.
- 22 Before clearing the generator set for use after maintenance or overhaul, submit it to a test run, check that the AC power performance is correct and that the control and shutdown devices function correctly.

## **1.6 Tool applications safety**

Apply the proper tool for each job. With the knowledge of correct tool use and knowing the limitations of tools, along with some common sense, many accidents can be prevented.

Special service tools are available for specific jobs and should be used when recommended. The use of these tools will save time and prevent damage to parts.

## **1.7 Battery safety precautions**

When servicing batteries, always wear protecting clothing and glasses.

- 1 The electrolyte in batteries is a sulphuric acid solution which is fatal if it hits your eyes, and which can cause burns if it contacts your skin. Therefore, be careful when handling batteries, e.g. when checking the charge condition.
- 2 Install a sign prohibiting fire, open flame and smoking at the post where batteries are being charged.
- 3 When batteries are being charged, an explosive gas mixture forms in the cells and might escape through the vent holes in the plugs.  
Thus an explosive atmosphere may form around the battery if ventilation is poor, and can remain in and around the battery for several hours after it has been charged. Therefore:
  - never smoke near batteries being, or having recently been, charged,
  - never break live circuits at battery terminals, because a spark usually occurs.

- 4 When connecting an auxiliary battery (AB) in parallel to the unit battery (CB) with booster cables: connect the + pole of AB to the + pole of CB, then connect the - pole of CB to the mass of the unit. Disconnect in the reverse order.

## 2 Main parts

### 2.1 General description

The QES 60-85-105-120-150-200 are generator sets, built for continuous running at sites where no electricity is available or as stand-by in cases of interruption of the mains. The QES 60-85-105-120-150-200 generator sets operate at 400V-50Hz and 480V-60hz. The QES 60-85-105-120-150-200 generator sets are driven by a fluid-cooled diesel engine, manufactured by John Deere. An overview of the main parts is given in the diagram below. Some parts of the unit might differ, depending on the version.

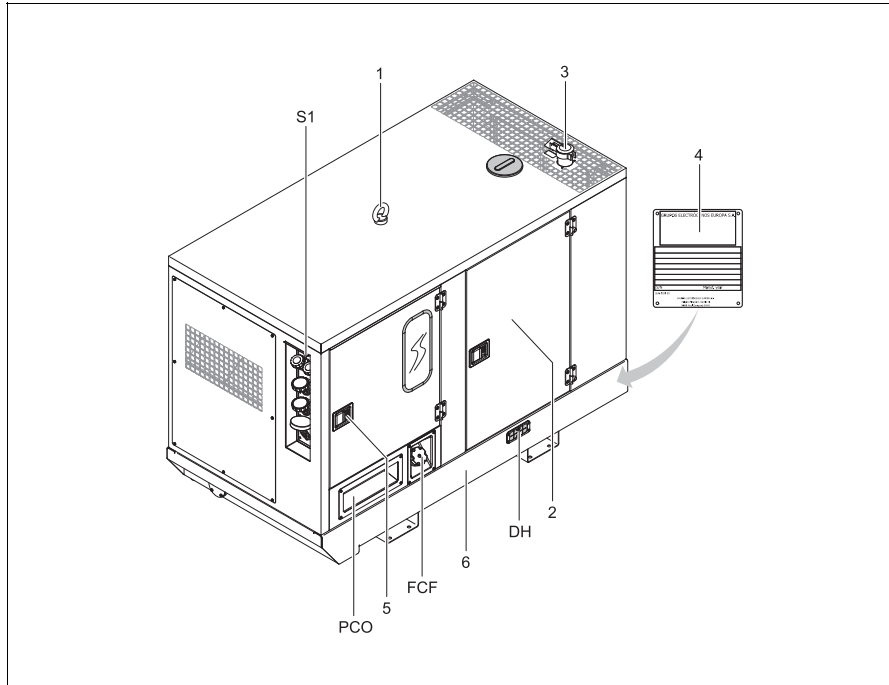

- 1 Lifting beam
  - 2 Side doors
  - 3 Engine exhaust
  - 4 Data plate
  - 5 Door, access to control and indicator panel
  - 6 Galvanized frame with forklift slots
- 
- DH Drain and access hole
  - FCF Filler cap fuel
  - PCO Power cable output
  - S1 Emergency stop

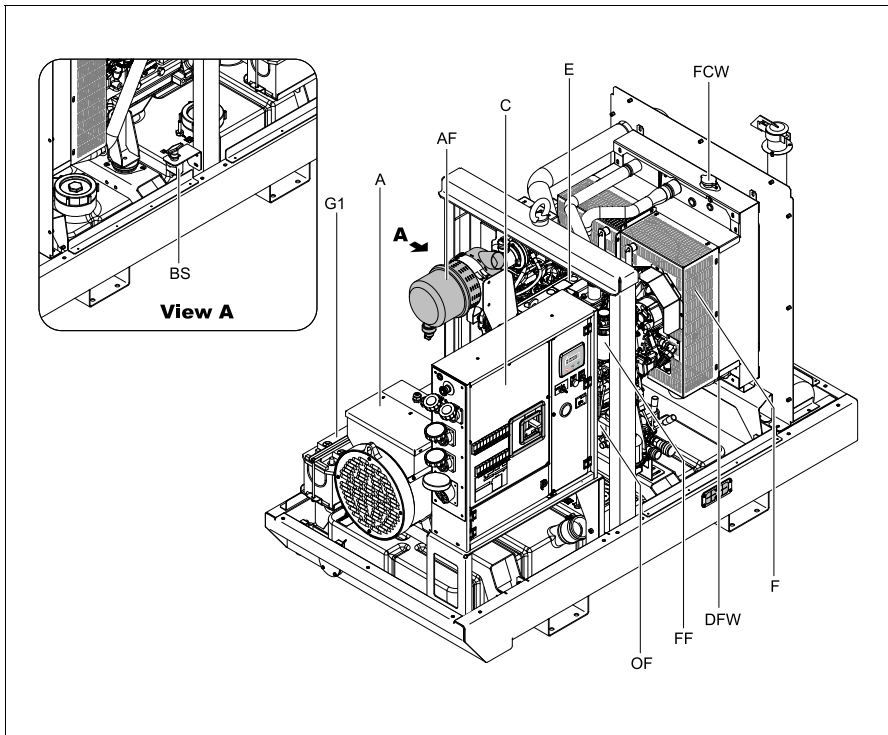

- A Alternator
- AF Air filter
- BS Battery switch
- C Cubicle
- DFW Drain flexible cooling water
- E Engine
- F Fan
- FCW Filler cap cooling water
- FF Fuel filter
- G1 Battery
- OF Oil filter



## 2.2 Markings

Markings provide instructions and information. They also warn of hazards. For convenience and safety, keep all markings in legible condition, replacing them when damaged or missing. Replacement markings are available from the factory.

A brief description of all markings provided on the generator set is given hereafter. The precise location of all markings can be found in the parts manual of this generator set.



Indicates the presence of electric shock hazards. Enclosures marked with these symbols should only be opened by trained or instructed people.



Indicates that these parts can become very hot during operation (e.g. engine, cooler, etc.). Always make sure that these parts are cooled down before touching them.



Indicates the sound power level in accordance with Directive 2000/14/EC (expressed in dB (A)).

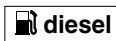

Indicates that the generator set may be refuelled with diesel fuel only.



Indicates the drain for the engine oil.



Indicates the drain for the coolant.



Indicates the drain plug for the engine fuel.



Use PAROIL E only.



Indicates that the alternator should not be cleaned with high pressurised water.

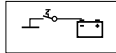

Indicates the battery switch.



Indicates that the unit may start automatically and that the instruction book has to be consulted prior to use.



Read the instruction manual before using the lifting eye.

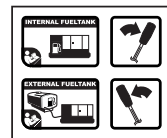

Indicates the 3-way valve.

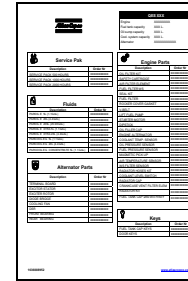

Indicates the different service packs, liquids and critical parts. These parts can be ordered to Atlas Copco.

## 2.3 Mechanical features

The mechanical features described in this chapter are standard provided on this generator set. For all other mechanical features, see chapter “Overview of the mechanical options” on page 76.

### 2.3.1 Engine and alternator

The alternator is driven by a fluid-cooled diesel engine. The engine’s power is transmitted through a direct disc coupling.

The generator set houses a single bearing alternator with a dedicated voltage regulator.

The synchronous brushless alternator has Class H rotor and stator windings in an IP21 housing.

### 2.3.2 Cooling system

The engine is provided with a water cooler. The cooling air is generated by a fan, driven by the engine.

### 2.3.3 Safety devices

The engine is equipped with low oil pressure and high coolant temperature shut-down switches.

### 2.3.4 Bodywork

The alternator, the engine, the cooling system, etc. are enclosed in a sound-insulated galvanized bodywork that can be opened by means of side doors (and service panels).

The generator set can be lifted by using the lifting eye integrated in the bodywork (roof). To be able to lift the QES 60 by means of a forklift, rectangular slots are provided in the frame.

The earthing rod, connected to the generator set’s earth terminal is located inside the generator set behind the alternator.

### 2.3.5 Control panel

The control panel grouping controller, fuel gauge, and control switch, is placed at the rear end of the right side of the generator set.

### 2.3.6 Data plate and serial number

The generator set is furnished with a data plate showing the product code, the unit number and the power output (see chapter “Data plate” on page 108).

The serial number is located at the front end of the right side of the frame.

### 2.3.7 Drain plugs and filler caps

The drain holes for the engine oil, the coolant and the plug for the fuel, are located and labelled on the frame. The fuel drain plug is located at the rear side, the others at the service side.

The drain flexible for engine oil can be brought to the outside of the generator set through the drain hole.



**The drain hole can also be used to guide external fuel tank connections. When connecting an external fuel tank, use the 3-way valves. Refer to chapter “External fuel tank connection (with/without quick couplings)”.**

The filler cap for the engine coolant is accessible via an opening in the roof. The fuel filler cap is located in the side panel.

### 2.3.8 Rustproof plastic fuel tank

To store fuel, which is classified as a hazardous product, the QES Jd generator sets are provided with a rustproof plastic fuel tank.

To extend the generator set autonomy, an optional external fuel tank can be installed near the generator set. See section “External fuel tank connection (with/without quick couplings)” on page 76.

Also, a 24-hours fuel tank can be optionally provided.

### **2.3.9 Spillage free skid**

A spillage free skid avoids accidental spilling of engine fluids and thus helps to protect the environment.

The leaking fluid can be removed via drain holes, secured by drain plugs. Tighten the plugs firmly and check for leakages. When removing the leaking fluid, observe all relevant local legislation.

### **2.3.10 Hot parts protection (CE compliance)**

The hot parts protection shields hot parts of the generator set (turbo and exhaust system) to reduce the risk of burns.

## 2.4 Electrical features

The electrical features described in this chapter are standard provided on this generator set. For all other electrical features, see chapter “Overview of the electrical options” on page 71.

### 2.4.1 Emergency stop

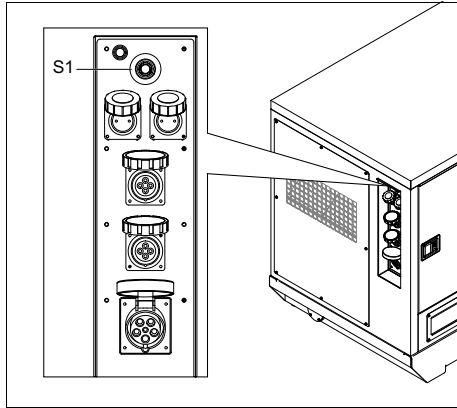

**S1** ..... Emergency stop button

Push the button to stop the generator set in case of an emergency. When the button is pressed, it must be unlocked, before the generator set can be restarted.

### 2.4.2 Qc1111™/Qc2111™ control module

To operate the generator set, the QES 60-85-105-120-150-200 control panel contains a Qc1111™ or Qc2111™ controller. The controller will carry out all necessary tasks to control and protect the generator set, which allows operation in many different applications. Additionally the optional Qc2111™ controller provides AMF functionality.

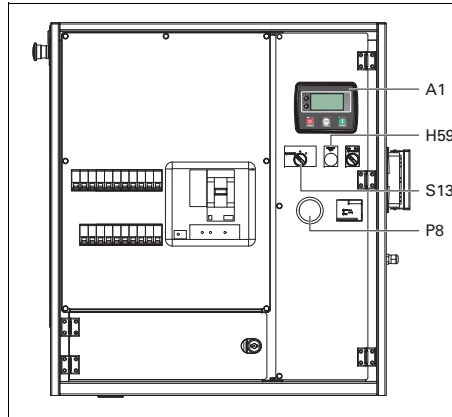

**A1** ..... Qc1111™/Qc2111™ display

**H59** ..... Preheat push button/indicator

**QES 60:** H59 is a push button used to manually activate the air heater (cold start option).

**QES 85-200:** H59 is a preheat indicator (yellow led) indicating when the engine air heater is operative.

**P8** ..... Fuel level gauge

**S13** ..... ON/OFF switch

Position O: No voltage is supplied to the Qc1111™/Qc2111™ module, the generator set will not start.

Position I: Voltage is supplied to the Qc1111™/Qc2111™ module, it is possible to start up the generator set.

Position Diagnostic (**QES 85-200 only**): for selecting the John Deere Service Advisor tool diagnostics.

### 2.4.3 Output terminal board

The cubicle provides a terminal board for easier connection of cables. It is situated below the control and indicator panel, hidden behind the control panel door and behind a small transparent door.

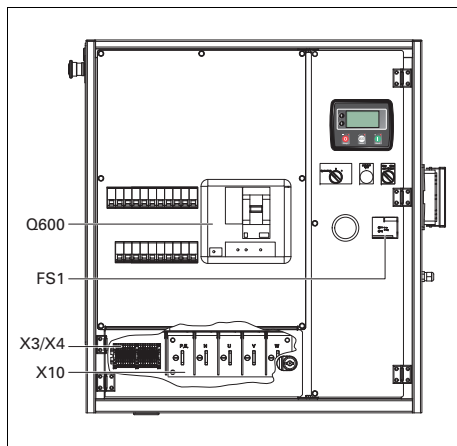

### *Q600... Main circuit breaker*

Interrupts the power supply to X10 when a short-circuit occurs at the load side, when the earth leak detector (30 mA) or the overcurrent protection (QES 60: 100 A, QES 80: 125 A, QES 100: 160 A, QES 120: 200 A, QES 150: 250 A, QES 200: 400 A) is activated, or when the shunt trip is energized. It must be reset manually after eliminating the problem.

### *X3/X4... Customer terminals*

### *X10 ..... Main power supply (400 V AC)*

Terminals L1, L2, L3, N (= neutral) and PE (= earthing), hidden behind the control panel door and behind a small transparent door.

### *FS1 ..... Earth leak detector*

Detects and indicates an earth fault current and activates the main circuit breaker Q600. The detection level can be set at 0.03 A fixed with instantaneous trip, but can also be adjusted between 0.1 A and 30 A with time delayed (0 - 4.5 sec) trip. FS1 has to be reset manually after eliminating the problem (Reset button) and has to be tested monthly (by pushing the Test button).

### 2.4.4 Earth leakage relay

An earth leakage relay provides protection in case of an earth leak current.

The functionality of the earth leakage relay should be tested daily to guarantee safe use of the generator set.

## 3 Installation and connection

### 3.1 Lifting

The lifting eye, to lift the generator set by means of a hoist, is integrated in the bodywork and easily accessible from the outside. The recesses in the roof have guiding rods at both sides.

When lifting the generator set, the hoist has to be placed in such a way that the generator set, which must be placed level, will be lifted vertically.

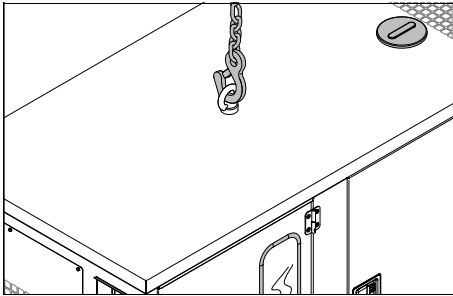

**Never use the guiding rods to lift the generator set.**



**Lifting acceleration and deceleration must be kept within safe limits (max. 2 g).**

**Helicopter lifting is not allowed.**

To be able to lift the QES 60 generator set by means of a forklift, rectangular slots are provided at the bottom of the frame.

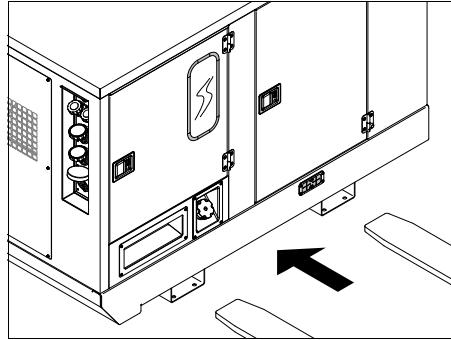

### 3.2 Installation

#### 3.2.1 Indoor installation

If the generator set is operated indoors, install an exhaust pipe of sufficient diameter to duct the engine exhaust towards the outside. Check for sufficient ventilation so that the cooling air is not recirculated.



**For more information about indoor installation, consult your local Atlas Copco dealer.**

#### 3.2.2 Outdoor installation

- Place the generator set on a horizontal, even and solid floor. The generator set can operate in a slant position not exceeding 15% (in both senses: front/rear and left/right).
- The generator set should be kept with the doors closed, in order to avoid the ingress of water and dust. Dust ingress reduces the lifetime of filters and may reduce your generator set's performance.
- Check that the engine exhaust is not directed towards people.
- Locate the rear end of the generator set upwind, away from contaminated wind streams and walls. Avoid recirculation of exhaust air from the engine. This causes overheating and engine power decrease.

- Leave enough space for operation, inspection and maintenance (at least 1 meter at each side).
- Check that the inner earthing system is in compliance with the local legislation.
- Use coolant for the engine cooling system. Refer to the Engine instruction book for the proper coolant mixture.
- Check the tightness of the bolts and nuts.
- Check that the cable end of the earthing rod is connected to the earth terminal.



**The generator set is wired for a TN-system to IEC 364-3, i.e. one point in the power source directly earthed - in this case the neutral. The exposed conductive parts of the electric installation must be directly connected to the functional earth. If operating the generator set in another power system, e.g. an IT-system, other protective devices required for these types must be installed. In any case only a qualified electrician is authorized to remove the connection between the neutral (N) and earth terminals in the terminal box of the alternator.**

### 3.3 Connecting the generator set

#### 3.3.1 Precautions for non-linear and sensitive loads



**Non-linear loads draw currents with high contents in harmonics, causing distortion in the wave form of the voltage generated by the alternator.**

The most common non-linear, 3-phase loads are thyristor/rectifier-controlled loads, such as convertors supplying voltage to variable speed motors, uninterruptable power supplies and Telecom supplies. Gas-discharge lighting arranged in single-phase circuits generate high 3rd harmonics and risk for excessive neutral current.

Loads most sensitive to voltage distortion include incandescent lamps, discharge lamps, computers, X-ray equipment, audio amplifiers and elevators.

Consult Atlas Copco for measures against the adverse influence of non-linear loads.

#### 3.3.2 Quality, minimum section and maximum length of cables

The cable connected to the terminal board of the generator set must be selected in accordance with local legislation. The type of cable, its rated voltage and current carrying capacity are determined by installation conditions, stress and ambient temperature. For flexible wiring, rubber-sheathed, flexible core conductors of the type H07 RN-F (Cenelec HD.22) or better must be used.

The following table indicates the maximum allowable 3-phase currents (in A), at an ambient temperature of 40°C, for cable types (multiple and single core PVC insulated conductors and H07 RN-F multiple core conductors) and wire sections as listed, in accordance with VDE 0298 installation method C3. Local regulations remain applicable if they are stricter than those proposed below.

Wire section (mm <sup>2</sup> )	Max. current (A)		
	Multiple core	Single core	H07 RN-F
2,5	22	25	21
4	30	33	28
6	38	42	36
10	53	57	50
16	71	76	67
25	94	101	88
35	114	123	110
50	138	155	138
70	176	191	170
95	212	228	205

The lowest acceptable wire section and the corresponding maximum cable or conductor length for multiple core cable or H07 RN-F, at rated current (20 A), for a voltage drop e lower than 5% and at a power factor of 0.80, are respectively 2.5 mm<sup>2</sup> and 144 m. In case electric motors must be started, oversizing the cable is advisable.

The voltage drop across a cable can be determined as follows:

$$e = \frac{\sqrt{3} \cdot I \cdot L \cdot (R \cdot \cos \varphi + X \cdot \sin \varphi)}{1000}$$

e = Voltage drop (V)

I = Rated current (A)

L = Length of conductors (m)

R = Resistance (Ω/km to VDE 0102)

X = Reactance (Ω/km to VDE 0102)

### 3.3.3 Connecting the load

#### 3.3.3.1 Site distribution panel

If outlet sockets are provided, they must be mounted on a site distribution panel supplied from the terminal board of the generator set and in compliance with local regulations for power installations on building sites.

#### 3.3.3.2 Protection



**For safety reasons, it is necessary to provide an isolating switch or circuit breaker in each load circuit. Local legislation may impose the use of isolating devices which can be locked.**

- Check whether frequency, voltage and current comply with the ratings of the generator set.
- Provide a load cable, without excessive length, and lay it out in a safe way without forming coils.

- Open the door of the control and indicator panel and the transparent door in front of the terminal board X10.
- Provide the wire ends with cable lugs suited for the cable terminals.
- Loosen the cable clamp and push the wire ends of the load cable through the orifice and clamp.
- Connect the wires to the proper terminals (L1, L2, L3, N and PE) of X10 and tighten the bolts securely.
- Tighten the cable clamp.
- Close the transparent door in front of X10.



## 4 Operating instructions



In your own interest, always strictly observe all relevant safety instructions.

Do not operate the generator set in excess of the limitations mentioned in the Technical Specifications.

Local rules concerning the setting up of low voltage power installations (below 1000 V) must be respected when connecting site distribution panels, switch gear or loads to the generator set.

At each start-up and at any time a new load is connected, the earthing and protections (GB trip and earth leakage relay) of the generator set must be verified. Earthing must be done either by the earthing rod or, if available, by an existing, suitable earthing installation. The protective system against excessive contact voltage is not effective unless a suitable earthing is made.

### 4.1 Before starting

- With the generator set standing level, check the engine oil level and top up if necessary. The oil level must be near to, but not exceed the high mark on the engine oil level dipstick.
- Check the coolant level in the expansion tank of the engine cooling system. The coolant level must be near to the FULL mark. Add coolant if necessary.
- Drain any water and sediment from the fuel pre-filter. Check the fuel level and top up if necessary. It is recommended to fill the tank after the day's operation to prevent water vapor in a nearly empty tank from condensing.
- Drain leaking fluid from the frame.
- Check the vacuum indicator of the air filter. If the red part shows completely, replace the filter element.
- Press the dust evacuator of the air filter to remove dust.
- Check the generator set for leakage, tightness of wire terminals, etc. Correct if necessary.
- Check that circuit breaker Q600 is switched off.
- Check that no circuit breakers have tripped and that the emergency stop is in the OUT position.
- Check that the load is switched off.
- Check that the earth fault protection (FS1) has not tripped (reset if necessary).

### 4.2 Operating and setting Qc1111™/Qc2111™

#### 4.2.1 Setting the Qc1111™/Qc2111™

##### 4.2.1.1 Button overview

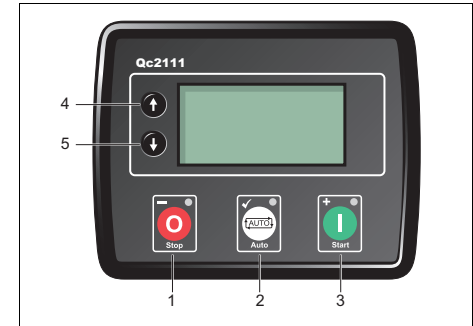

1



**STOP/RESET:** Allows to put the control module in **Stop/Reset** mode. When pressing the STOP button, the generator set will unload, the fuel supply de-energises and the engine shuts down. Pressing the STOP button will also clear any alarm conditions for which the triggering criteria have been removed.

2



**AUTO:** Allows to put the control module in **Auto** mode.

3



**START:** Allows to put the control module in **Manual/Start** mode.

4



**UP:** Is used for navigating the instrumentation, event log and configuration screens and to go to the previous parameter level.

5



**DOWN:** Is used for navigating the instrumentation, event log and configuration screens and to go to the next parameter level.

#### 4.2.1.2 LED overview



1	<b>Stop/Reset</b>	LED will flash upon electrical trip and shutdown fault.
2	<b>Auto</b>	LED indicates that the unit is in Auto Mode.
3	<b>Start/Manual</b>	LED will flash upon 'Waiting in Manual mode'.

#### 4.2.1.3 Graphical display

##### General



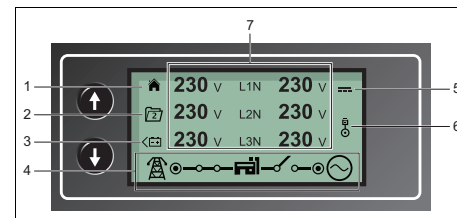





The Qc1111™ /Qc2111™ graphical display shows the instrumentation, active configuration, operating mode, load switching status and alarm conditions. It is segmented into 7 areas:













1	Instrumentation icon
2	Active configuration
3	FPE/Auto Run
4	Load switching icon
5	Alarm icon
6	Mode icon
7	Instrumentation and Unit e.g. voltage reading



## Icons overview

### Instrumentation icons

Display	Description
	Default home page displaying generator set voltage and mains voltage (Qc2111™ only)
	Generator voltage and frequency instrumentation screen
	Mains voltage and frequency instrumentation screen (Qc2111™ only)
	Generator current instrumentation screen
	Mains current instrumentation screen (Qc2111™ only)
	Load power instrumentation screen
	Engine speed instrumentation screen
	Hours run instrumentation screen
	Battery voltage instrumentation screen





Display	Description
	Oil pressure instrumentation screen
	Coolant temperature instrumentation screen
	Flexible sender instrumentation screen
	Appears when the event log is being displayed
	Current time held in the unit
	The current value of the scheduler run time and duration
	ECU diagnostic trouble codes
	Oil filter maintenance timers
	Air filter maintenance timers
	Fuel filter maintenance timers

### Active configuration icons









Display	Description
	Appears when the main configuration is selected
	Appears when the alternative configuration is selected

### Front panel editor (FPE) / Auto run icons

When running in Auto mode, an icon is displayed on the home page, in the FPE / Auto run section to indicate the source of the auto start signal.

Display	Description
	Appears when a remote start input is active
	Appears when a low battery run is active
	Appears in case of a mains failure (Qc2111™ only)
	Appears when a scheduled run is active

## Mode icons

Display	Description
	Appears when the engine is at rest and the unit is in stop mode
	Appears when the engine is at rest and the unit is in auto mode
	Appears when the engine is at rest and the unit is waiting for a manual start
	Appears when a timer is active, for example cranking time, crank rest etc.
	Appears when the engine is running, and all timers have expired, either on or off load. The animation speed is reduced when running in idle mode.
	Appears when the unit is in the front panel editor
	Appears when a USB connection is made to the controller
	Appears if either the configuration file or engine file becomes corrupted

## Load switching icons

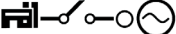
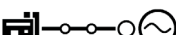
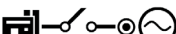
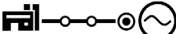
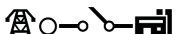
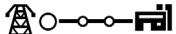
Display	Description
	Appears when the generator set is at rest or not available and when the generator breaker is open.
	Appears when the generator set is at rest or not available and the generator breaker has failed to open.
	Appears when the generator set is available and the generator breaker is open.
	Appears when the generator set is available and the generator breaker is closed.
	Appears when the mains supply is not available and the mains breaker is open. (Qc2111™ only)
	Appears when the mains supply is not available and the mains breaker is closed. (Qc2111™ only)

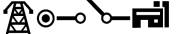
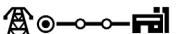
Display	Description
	Appears when the mains supply is available and the mains breaker is open. (Qc2111™ only)
	Appears when the mains supply is available and the mains breaker is closed. (Qc2111™ only)

Note: the controller gives only an indication of the position of the mains and generator set breaker and may be different from the actual breaker position.

## Alarm icons

To indicate the alarm that is currently active on the controller, an Alarm icon will be displayed in the Icon section.

For an overview of all controller alarms, see “Solving Qc1111™/Qc2111™ controller alarms” on page 61.

## Back light

The back light will be on if the unit has sufficient voltage while the unit is turned on. When the unit is cranking the back light is turned off.

#### 4.2.1.4 Qc1111™/Qc2111™ menu overview

##### Navigation menu



To enter the navigation menu, press both the UP and DOWN buttons simultaneously.

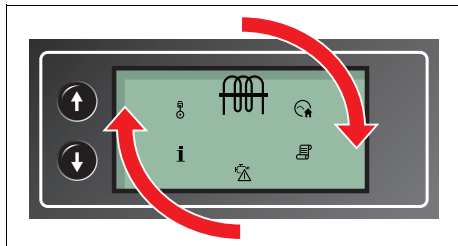





To cycle through the icons, press the UP and DOWN button. When the desired icon is at the top of the display press the AUTO (Accept) button to enter that specific instrumentation page.



If the AUTO button is not pressed, the display automatically returns to the home page.

##### Navigation menu icons

Display	Description
	Generator and mains voltage instrumentation (Qc2111™ only)
	Generator instrumentation

Display	Description
	Mains instrumentation (Qc2111™ only)
	Current and load instrumentation
	Engine instrumentation
	Module information
	Engine DTCs (Diagnostic Trouble Codes), if active
	Event Log

##### General navigation

It is possible to scroll through the display to view different pages of information by repeatedly operating the UP or DOWN navigation buttons.

Example:

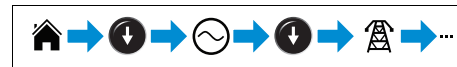

Further press of the DOWN button, returns the display to the Home page.

Once selected, a page will remain on the LCD display until the user selects a different page, or after an extended period of inactivity (Page Delay Timer), the module will revert to the Home page.

##### Home page

This is the page that is displayed when no other page has been selected and is automatically displayed after a period of inactivity (Page Delay Timer) of the module facia buttons. It also contains the voltage reading of the generator set and mains (Qc2111™ only) that is measured from the module's voltage inputs.

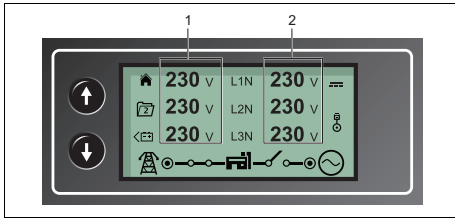

- 1 | Mains voltage (ph-N / ph-ph) (Qc2111™ only)
- 2 | Generator voltage (ph-N / ph-ph)

### Generator pages

These pages contain electrical values of the generator set, measured or derived from the module's voltage inputs.

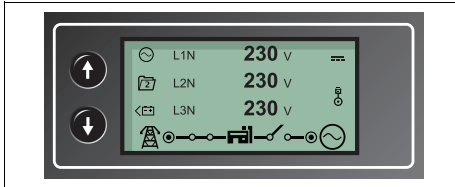

- Generator Voltage (ph-N)
- Generator Voltage (ph-ph)
- Generator Frequency

### Mains pages (Qc2111™ only)

These pages contain electrical values of the mains, measured or derived from the module's voltage inputs.

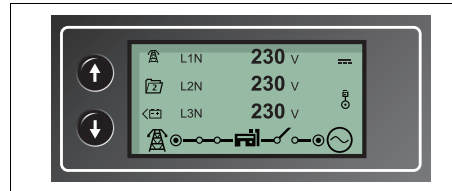

- Mains Voltage (ph-N)
- Mains Voltage (ph-ph)
- Mains Frequency

### Load pages

These pages contain electrical values of the load, measured or derived from the module's voltage and current inputs. The power values displayed depend on which supply is on load.

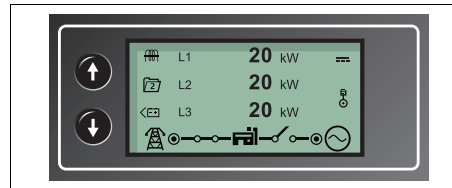

- Generator Current (A)
- Mains Current (A) (Qc2111™ only)
- Load ph-N (kW)
- Total Load (kW)
- Load ph-N (kVA)
- Total Load (kVA)
- Load ph-N (kVAR)
- Total Load (kVAR)
- Power Factor ph-N
- Power Factor Average
- Accumulated Load (kWh, kVAh, kVARh)

## Engine pages

These pages contain engine instrumentation, measured or derived from the module's inputs, some of which may be obtained from the engine ECU.

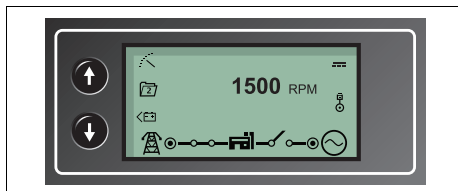

- Engine Speed
- Engine Run Time
- Engine Battery Volts
- Engine Coolant Temperature
- Engine Oil Pressure
- Engine Fuel Level / Flexible Sensor
- Engine Maintenance Due – Oil
- Engine Maintenance Due – Air
- Engine Maintenance Due – Fuel

## Info pages

These pages contain information about the controller.

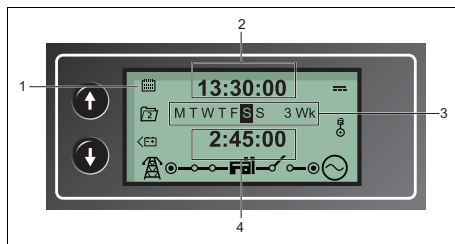

- 1 Icon to indicate that the scheduler is currently displayed
  - 2 Start time of scheduled run
  - 3 Day and week of scheduled run
  - 4 Duration of scheduled run
- Module's date and time
  - Scheduler settings
  - Product description and USB identification number
  - Application and Engine Version

## Engine DTC (ECU alarms)

This page contains active Diagnostic Trouble Codes (DTC), if the engine ECU generates a fault code. The alarm conditions are detected by the engine ECU and displayed by the Qc1111™/Qc2111™ controller.

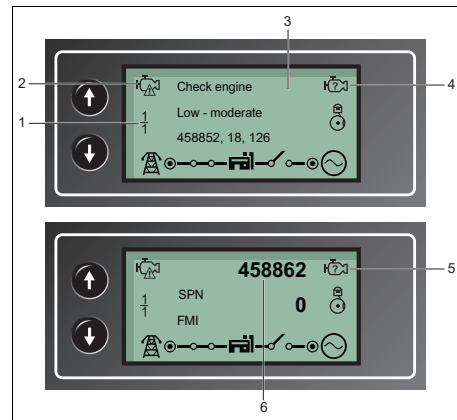







- 1 Number of DTC displayed out of number of active DTCs
- 2 Icon to indicate that the event log is currently displayed
- 3 Description and fault code of active DTC alarm
- 4 Icon to indicate the type of DTC fault that is active
- 5 Current operating state of the module
- 6 SPN and FMI fault code of active DTC alarm

To view the active engine DTC(s):

1. Press the UP and DOWN buttons simultaneously to display the navigation menu.
2. Once entered, cycle to the DTC icon and enter.
3. To view the active DTC(s) alarms, repeatedly press the UP or DOWN buttons until the LCD screen displays the alarm.
4. Continuing to press the UP or DOWN buttons will cycle through the alarms.
5. To exit the active DTC(s) alarm section, press the UP and DOWN buttons simultaneously. The navigation menu will be displayed.

### CAN fault icons

Display	Description
	Check Engine Fault: The engine ECU has detected a fault not recognised by the Qc1111™ /Qc2111™ module, contact the engine manufacturer for support.
	Low Oil Pressure: The engine ECU has detected that the engine oil pressure has fallen below its configured low oil pressure alarm level.
	Under Speed: The engine ECU has detected that the engine speed has fallen below its configured under speed alarm level.
	Over Speed: The engine ECU has detected that the engine speed has risen above its configured over speed alarm level.
	Charge Failure: The engine ECU has detected that the engine's charge alternator output has fallen below its configured alarm level.
	Low Fuel Level: The engine ECU has detected that the engine's fuel level has fallen below its configured low fuel level alarm

Display	Description
	Battery Under/Over Voltage The engine ECU has detected that the engine's DC supply has fallen below or risen above its configured alarm level.

For more details on these code meanings, refer to the ECU instructions provided by the engine manufacturer, or contact the engine manufacturer for further assistance.



## Event log

The Qc1111™/Qc2111™ event log contains a list of the last 15 recorded electrical trip or shutdown events and the engine hours at which they occurred.

Once the log is full, any subsequent electrical trip or shutdown alarm will overwrite the oldest entry in the log. Hence, the log always contains the most recent shutdown alarms. The module logs the alarm, along with the engine running hours.

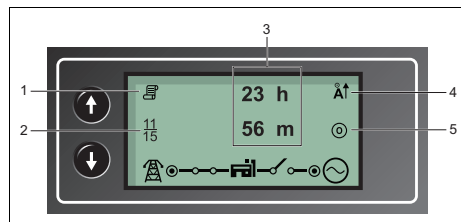

- 1 Icon to indicate that the event log is currently displayed
- 2 Number of displayed event
- 3 Engine hours at which the event occurred
- 4 Icon to indicate the electrical trip or shutdown alarm that has been recorded
- 5 Current operating mode of the module

To view the event log:

1. Press the UP and DOWN buttons simultaneously to display the navigation menu.
2. Once entered, cycle to the event log icon (1) and enter.
3. To view the event log, repeatedly press the UP or DOWN buttons until the LCD screen displays the desired event.
4. Continuing to press the UP or DOWN buttons will cycle through the past alarms.
5. To exit the event log, press the UP and DOWN buttons simultaneously. The navigation menu will be displayed.

## 4.2.2 Generator set operating modes

The generator set can be used in 3 operating modes:

- Stop/Reset mode,
- Automatic mode,
- Manual/Start mode

### 4.2.2.1 Stop mode

1. Activate Stop/Reset mode by pressing the STOP/RESET button.

The Stop/Reset icon will be displayed on the Qc1111™/Qc2111™ controller.

2. In Stop/Reset mode, the module will remove the generator set from load (if necessary) before stopping the engine, if it is already running.

If the engine does not stop when requested, the FAIL TO STOP alarm is activated. To detect the engine at rest the following must occur:

- Engine speed is zero as detected by the CANbus ECU.
- Generator AC Voltage and Frequency must be zero.
- Engine Charge Alternator Voltage must be zero.
- Oil pressure sensor must indicate low oil pressure

3. When the engine has stopped, it is possible to send configuration files to the module from Qc Configuration Suite PC software and to enter the Front Panel Editor to change parameters.
4. Any latched alarm that has been cleared will be reset when STOP mode is entered.

When the engine is running and the module is put into Stop/Reset mode, the module will automatically instruct the generator set to unload ('Close Generator' and 'Delayed Load Output 1, 2, 3 & 4' become inactive (if used)). The fuel supply de-energises and the engine comes to a standstill. Should any form of remote start signal be present while operating in this mode, a start will not occur.

#### 4.2.2.2 Auto mode / Mains failure

On generator sets equipped with a Qc2111™ controller, this mode of operation is used to ensure continuity of supply to critical loads during a mains failure condition. This is the normal mode of operation when installed on a stand-by generator set.

Activate Auto mode by pressing the AUTO push button. An LED indicator beside the button confirms this action. The Auto Mode icon appears on the display to indicate Auto Mode operations if no alarms are present.

Auto mode will allow the generator set to operate fully automatically, starting and stopping as required with no user intervention.

#### Starting

1. If a starting request is made, the starting sequence will begin.

Starting requests can be from the following sources:

- Mains supply out of limits (Qc2111™ only).
- Activation of an auxiliary input that has been configured to remote start.
- Activation of the inbuilt exercise scheduler.

2. To allow for 'false' start requests, the start delay timer begins.

Should all start requests be removed during the start delay timer, the unit will return to a stand-by state.

3. If a start request is still present at the end of the start delay timer, the fuel relay is energised and the engine will be cranked.

#### NOTE:

If the unit has been configured for CAN, compatible ECU's receive the start command via CAN and transmit the engine speed to the Qc1111™/Qc2111™ controller.

4. If the engine fails to fire during this cranking attempt, the starter motor is disengaged for the crank rest duration after which the next start attempt begins. Should this sequence continue beyond the set number of attempts, the start sequence will be terminated and the display shows 'Fail to Start'.

#### Engine running

1. Once the engine is running and all starting timers have expired, the animated Engine Running icon will be displayed.
2. The generator set is placed on load if configured to do so.

#### NOTE:

The load transfer signal remains inactive until the Oil Pressure has risen. This prevents excessive wear on the engine.

3. If all start requests are removed, the stopping sequence will begin.

## Stopping

1. The return delay timer operates to ensure that the starting request has been permanently removed and is not just a short term removal.

Should another start request be made during the cooling down period, the set will return on load.

2. If there are no starting requests at the end of the return delay timer, the load is removed from the generator set to the mains supply (Qc2111™ only) and the cooling timer is initiated.

The cooling timer allows the set to run off load and cool sufficiently before being stopped. This is particularly important where turbo chargers are fitted to the engine.

3. After the cooling timer has expired, the set is stopped.

### 4.2.2.3 Manual mode

Activate Manual mode by pressing the START push button. An LED indicator beside the button confirms this action.

Manual mode allows the operator to start and stop the set manually.

If the engine is running off-load in Manual/Start mode and a remote start signal becomes present, the module will automatically instruct the changeover device to place the generator set on load ('Close Generator' and 'Delayed Load Output 1, 2, 3 & 4' becomes active (if used)). Upon removal of the Remote Start Signal, the generator set remains on load until Stop/Reset mode or Auto mode are selected.

NOTE: If a digital input configured to panel lock is active, changing module modes will not be possible. Viewing the instruments and event logs is NOT affected by panel lock.

### Starting sequence

When in manual mode, the set will not start automatically.

1. To begin the starting sequence, press the START button.
  - If 'protected start' is disabled, the start sequence begins immediately.
  - If 'Protected Start' is enabled, the Waiting in Manual mode icon is displayed and the LED above the START button flashes. The START button must be pressed once more to begin the start sequence.

2. The fuel relay is energised and the engine is cranked.

If the engine fails to fire during this cranking attempt, the starter motor is disengaged for the crank rest duration after which the next start attempt is made. Should this sequence continue beyond the set number of attempts, the start sequence will be terminated and the display shows 'Fail to Start'.

3. When the engine fires, the starter motor is disengaged. Speed detection is factory configured to be derived from the main alternator output frequency.

Additionally, rising oil pressure can be used to disconnect the starter motor (but it cannot detect underspeed or overspeed).

4. After the starter motor has disengaged, the Safety On timer activates, allowing Oil Pressure, High Engine Temperature, Under-speed, Charge Fail and any delayed Auxiliary fault input to stabilise without triggering the fault.

## Engine running

Once the engine is running and all starting timers have expired, the animated Engine Running icon is displayed.

In manual mode, the load is not transferred to the generator set unless a 'loading request' is made. A loading request can come from a number of sources.

- Activation of an auxiliary input that has been configured to Remote Start On Load or Auxiliary Mains Fail.
- Activation of the inbuilt exercise scheduler if configured for 'on load' runs.

NOTE: The load transfer signal remains inactive until the Oil Pressure has risen. This prevents excessive wear on the engine.

Once the generator set has been placed on load, it is not automatically removed. To manually remove the load, either:

- Press the AUTO button to go to Auto mode.  
The set observes all Auto mode start requests and stopping timers before beginning the Auto mode Stopping Sequence.
- Press the STOP/RESET button to remove load and stop the generator set.
- Activation of an auxiliary input that has been configured to Generator Load Inhibit.

## Stopping

In manual/start mode the set will continue to run until either:

- The STOP/RESET button is pressed  
The delayed load outputs are de-activated immediately and the set immediately stops.
- The AUTO button is pressed.

The set observes all Auto mode start requests and stopping timers before beginning the Auto mode Stopping Sequence.

## 4.2.3 Front panel configuration

This configuration mode allows the operator limited customising of the way the module operates.

Use the module's navigation buttons to traverse the menu and make value changes to the parameters.

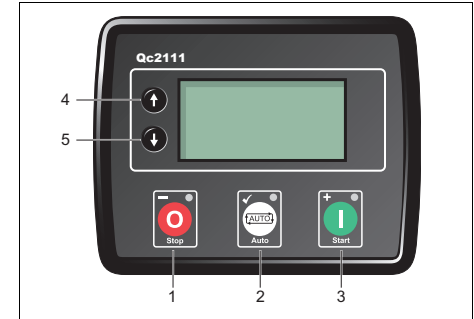

- 1 | Next Section (101-201-301)
- 2 | Previous Section (301-201-101)
- 3 | Previous Parameter (103-102-101)
- 4 | Edit or Save Parameter
- 5 | Next Parameter (101-102-103)

1. Press the STOP and AUTO buttons together to enter the editor mode.
2. Press the UP or DOWN button to cycle through the front panel editor to select the required page in the configuration tables.
3. Press the START button to select the next parameter or the STOP button to select the previous parameter within the current page.

4. When viewing the parameter to be edited, press the AUTO (Accept) button, the value begins to flash.
5. Press the START or STOP button to adjust the value to the required setting.
6. Press the AUTO (Accept) button the save the current value, the value ceases flashing.
7. Press and hold the AUTO (Accept) button to save and exit the editor, the configuration icon is removed from the display.



**Pressing and holding the START or STOP button will enable auto-repeat functionality. Values can be changed quickly by holding the buttons for a prolonged period of time.**



**The editor automatically exits after 5 minutes of inactivity to ensure security.**

## 5 Maintenance

### 5.1 Maintenance schedule



Before carrying out any maintenance activity, check that the start switch is in position O and that no electrical power is present on the terminals.

Maintenance schedule	Daily	100 hrs after initial start-up	Every 500 hours	Every 1000 hours	Every 2000 hours	Every 5000 hours	Yearly
Service pack QES 60	-	-	1636310461	1636310462	1636310463	-	-
Service pack QES 85	-	-	1636310464	1636310465	1636310466	-	-
Service pack QES 105/120	-	-	1636310464	1636310465	1636310467	-	-
Service pack QES 150/200	-	-	1636310468	1636310469	1636310470	-	-
<p><i>For the most important subassemblies, Atlas Copco has developed service kits that combine all wear parts. These service kits offer you the benefits of genuine parts, save on administration costs and are offered at reduced price, compared to the loose components. Refer to the parts list for more information on the contents of the service kits.</i></p>							
Drain water from fuel filter	x						
Check/Fill fuel level (3)	x						
Empty air filter vacuator valves	x						
Check air intake vacuum indicators	x						
Check engine oil level (if necessary top up)	x						
Check coolant level	x						
Check control panel for alarms and warnings	x						
Check on abnormal noise	x						
Check function of coolant heater (option)			x				x
Replace air filter element (1)			x				x
Check/Replace safety cartridge				x			x
Change engine oil (2) (6)		x	x	x			x

Maintenance schedule	Daily	100 hrs after initial start-up	Every 500 hours	Every 1000 hours	Every 2000 hours	Every 5000 hours	Yearly
Replace engine oil filter (2)		x	x	x			x
Replace fuel (primary)filter(s) (5)			x	x			x
Replace fuel (secondary)filter(s) (5)			x	x			x
Inspect/Adjust fan/alternator belt		x	x	x			x
Replace fan/alternator belt					x		x
Measure alternator insulation resistance (11)				x			x
Test Earth Leakage Relay (13)	x						
Check emergency stop (13)	x						
Clean radiator (1)			x	x			x
Check for obstructions on crankcase breather system / filter and hoses			x				x
Drain condensate and water from spillage-free frame or catch basin (8)			x	x	x		x
Check for leaks in engine-, air-, oil-, or fuel system			x	x	x		x
Inspect/Replace hoses and clamps			x	x	x		x
Check electrical system cables for wear				x			x
Check torque on critical bolt connections (12)				x	x		x
Check electrolyte level and terminals of battery (10)			x	x	x		x
Analyse coolant (4) (7)			x	x	x		x
Check external fuel connection (option)				x			x
Grease locks and hinges			x	x			x
Check rubber flexibles (9)				x			x
Drain/Clean fuel tank water and sediment (1) (14)				x			x
Adjust engine inlet and outlet valves (2)					x		x
Check vibration damper (QES 150-200 only)						x	

Maintenance schedule	Daily	100 hrs after initial start-up	Every 500 hours	Every 1000 hours	Every 2000 hours	Every 5000 hours	Yearly
Check fuel injectors (2)				X			
Check engine protective devices				X			X
Inspect starter motor							X
Inspect turbocharger				X			X
Inspect water pump				X			X
Inspect charging alternator				X			X
Check that mast cable are not frayed or damaged. Replace immediately if damaged.		X					
Grease the mast collar		X	X	X			X
Inspection by Atlas Copco service technician			X	X			X
		<b>Generator sets in stand-by application have to be tested on a regular basis. At least once a month the engine should run for one hour. If possible a high load (&gt; 30%) should be applied so that the engine reaches its operating temperature.</b>					



<b>Maintenance schedule</b>	<b>Daily</b>	<b>50 km after initial start-up</b>	<b>Every 500 km</b>	<b>Every 1000 km</b>	<b>Yearly</b>
Check tyre pressure		x	x	x	x
Check tyres for uneven wear				x	x
Check torque of wheel nuts		x		x	x
Check coupling head	x			x	x
Check height of adjusting facility	x				x
Check tow bar handbrake lever spring actuator, reversing lever, linkage and all movable parts for ease of movement	x	x	x	x	x
Grease coupling head, tow bar bearings at the housing of the overrun brake		x		x	x
Check brake system (if installed) and adjust if necessary		x		x	x
Oil or grease brake lever and moving parts such as bolts and joints		x		x	x
Grease sliding points on height adjusting parts				x	x
Check safety cable for damage				x	x
Check Bowden cable on height adjustable connection device for damage				x	x
Lubricate torsion bar axle trailing arm				x	x
Check brake lining wear					x
Change wheel hub bearing grease					x
Check/Adjust lateral play of wheel bearing (conventional bearing)			x	x	x

**Notes:**

In highly dusty environments, these service intervals do not apply. Check and/or replace filters and clean radiator on a regular basis.

- (1) More frequently when operating in a dusty environment.
- (2) Refer to engine operation manual.
- (3) After a days work.
- (4) Yearly is only valid when using PARCOOL. Change coolant every 5 years.
- (5) Gummed or clogged filters means fuel starvation and reduced engine performance. Reduce service interval in heavy duty application.
- (6) See chapter “Engine oil specifications”.
- (7) The following part numbers can be ordered from Atlas Copco to check on inhibitors and freezing points:
  - 2913 0028 00: refractometer
  - 2913 0029 00: pH meter
- (8) See chapter “Before starting”.
- (9) Replace all rubber flexibles every 5 years, according to DIN20066.
- (10) See chapter “Battery care”.
- (11) See chapter “Measuring the alternator insulation resistance”.
- (12) See chapter “Critical bolt connections - torque values”.

- (13) The function of this protection should be tested minimum on every new installation.
- (14) Water in fuel tank can be detected by means of 2914 8700 00. Drain fuel tank when water is detected.

**5.1.1 Use of maintenance schedule**

The maintenance schedule contains a summary of the maintenance instructions. Read the respective section before taking maintenance measures.

When servicing, replace all disengaged packing, e.g. gaskets, O-rings, washers.

For engine maintenance refer to Engine Operation Manual.

The maintenance schedule has to be seen as a guideline for units operating in a dusty environment typical to generator set applications. Maintenance schedule can be adapted depending on application, environment and quality of maintenance.

**5.1.2 Use of service packs**

Service packs include all genuine parts needed for normal maintenance of both generator set and engine. Service packs minimize downtime and keep your maintenance budget low.

The order number of the service packs are listed in the Atlas Copco Parts list (ASL). Order service packs at your local Atlas Copco dealer.

## 5.2 Preventing low loads

### 5.2.1 General

All engine parts are designed with tolerances to allow work under full load conditions. When operating at low load, these tolerances allow more lube oil to pass between valve guides, stems, liners and pistons due to the lower engine temperatures.

Lower combustion pressure has an influence on the piston ring operation and the combustion temperature. Low boost pressure will cause oil leakage over the turbo shaft seal.

### 5.2.2 Risks of low load operation

- Cylinder glazing: the cylinder bore troughs become filled with lacquer, displacing oil and thus preventing correct ring lubrication.
- Bore polishing: the bore surface becomes polished, all peaks and most troughs become worn away, also preventing correct ring lubrication.
- Heavy carbon buildup: on pistons, piston ring grooves, valves and turbo charger. Carbon buildup on pistons can cause seizure when later operating at full load.
- High oil consumption: prolonged no-load/low load operation of the engine may cause it to blue/gray smoke at low rpm with an associated increase in oil consumption

- Low combustion temperature: this will result in insufficiently burnt fuel, which will cause diluting of the lube oil. Also, unburnt fuel and lube oil can enter the exhaust manifold and eventually leak out through joints in the exhaust manifold.
- Risk for fire

### 5.2.3 Best practices

Reduce the low load periods to a minimum. This should be achieved by adequately sizing the unit for the application.

It is recommended that a unit is always used with a load > 30% of nominal. Corrective actions should be taken if due to circumstances this minimum load capacity cannot be obtained.

Operate the unit at full load capacity after any low load operating period. Therefore, connect the unit periodically to a load bank. Increase the load in steps of 25% every 30 minutes and allow the unit to run for 1 hour in full load condition. Gradually return the unit to the operating load.

The interval between load bank connections may vary according to the conditions present on site and the amount of load. However, a rule of thumb is to connect a unit to a load bank after every maintenance operation.

If the engine is installed as a stand-by generator set, then it should be operated at full load for at least 4 hrs/year. If periodic tests are performed on a regular basis without load, these should not exceed 10 min. Full load tests help to clean out the carbon deposits in the engine and exhaust system and evaluate the engine's performance. To avoid potential problems during the test, load should be gradually increased.

In rental applications (where the load is often an unknown factor) units should be tested at full load after each rental job or every 6 months, whichever comes first.

For more info, please contact your Atlas Copco Service Center.



**When a failure occurs and is deemed due to low load operation, the repairs fall outside warranty coverage.**

## 5.3 Alternator maintenance procedures

### 5.3.1 Measuring the alternator insulation resistance

A 500 V megger is required to measure the alternator insulation resistance.

If the N-terminal is connected to the earthing system, it must be disconnected from the earth terminal. Disconnect the AVR.

Connect the megger between the earth terminal and terminal L1 and generate a voltage of 500 V. The scale must indicate a resistance of at least 2 MΩ.

Refer to the alternator operating and maintenance instructions for more details.

## 5.4 Engine maintenance procedures

Refer to the engine's operator manual for full maintenance, including instructions for changing the oil and coolant and replacing the fuel, oil and air filters.

### 5.4.1 Engine oil level check

For the intervals, see section "Maintenance schedule" on page 38. Use Atlas Copco engine oil PAROIL E or PAROIL Extra.

Check the engine oil level every time before the generator set is used. To do this you must ensure that the machine stands on an even surface and that the engine is not running.

1. Check the engine oil level before starting or 10 minutes after stopping the engine.

2. Remove the oil level dipstick (2), wipe it clean and reinstall it.
3. Take the oil level dipstick out again, and check the oil level. Oil level reading should be within the crosshatch marks on the dipstick.
4. If the oil level is too low, remove the oil filler cap (1) and add the correct Atlas Copco engine oil to the prescribed level. The filler cap's position may vary depending on the engine application.

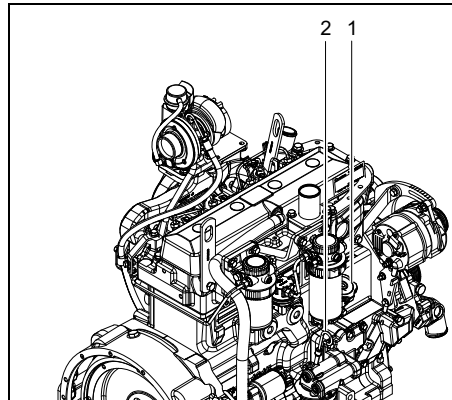

## 5.4.2 Engine oil and oil filter change



Observe all relevant environmental and safety precautions.



Be sure to stop the engine before draining engine oil or changing the oil filter cartridge.



Allow the engine to cool down sufficiently; oil can be hot and cause burns.

To change engine oil and oil filter:

1. Run the engine for approximately 5 minutes to warm up the oil. Stop the engine.
2. Remove the oil drain plug (1). Its position may vary depending on the engine application.

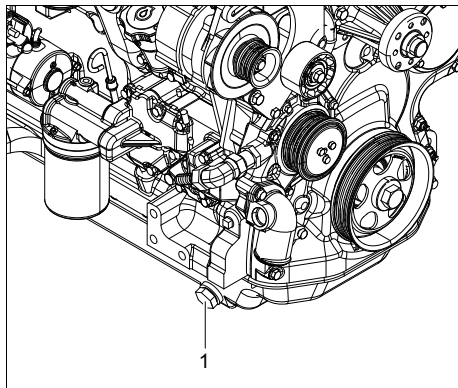

3. Drain crankcase oil from the engine while warm.
4. Loosen and remove the filter element (2) by using a suitable filter wrench. Discard the oil filter element. The position of the oil filter may vary depending on the engine application.



Filtration of engine oil is critical to proper lubrication. Therefore, change the oil filter regularly, respecting the intervals specified in the “Maintenance schedule”.

Use an oil filter, meeting the Atlas Copco performance specifications.

5. Apply clean engine oil to the inner and outer seals of the new filter (3) and to the filter threads.
6. Wipe both sealing surfaces of the header (4) with a clean rag.
7. Ensure the notches in the dust seal (5) are properly installed in the slots of the housing. Replace the dust seal if damaged.
8. Install the filter element, **hand tighten only**. A filter wrench should be used for removal only.
9. Install and tighten the oil filter by hand, until it is firmly seated against the dust seal. **DO NOT** apply an extra 3/4 or 1-1/4 turn after gasket contacts, as done for standard filters.
10. Fill the engine crankcase through the oil filler cap, using the correct Atlas Copco engine oil.

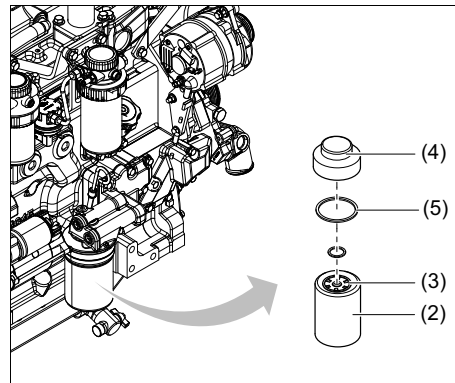

**Immediately after completing the oil change, crank the engine for 30 seconds, without permitting the engine to start. This will help to insure adequate lubrication of the engine components, before the engine starts.**



The oil capacity of the crankcase may slightly vary. **ALWAYS fill the crankcase within the crosshatch marks on the dipstick. DO NOT overfill.**

11. Start the engine and check for possible leaks, while the engine is running.
12. Stop the engine and check the oil level after 10 minutes. Oil level reading should be within the crosshatch marks on the dipstick.

## 5.4.3 Coolant check

### 5.4.3.1 Monitoring coolant condition

In order to guarantee the lifetime and quality of the product, thus to optimise engine protection, regular coolant-condition-analysis is advisable.

The quality of the product can be determined by three parameters.

#### Visual check

- Verify the outlook of the coolant regarding colour and make sure that no loose particles are floating around.



**Long service intervals  
5-year drain interval to minimize  
service costs (when used in  
accordance with the instructions).**

#### pH measurement

- Check the pH value of the coolant using a pH-measuring device.
- The pH-meter can be ordered from Atlas Copco with part number 2913 0029 00.
- Typical value for EG = 8.6.
- If the pH-level is below 7 or above 9.5, the coolant should be replaced.

## Glycol concentration measurement

- To optimise the unique engine protection features of the PARCOOL EG the concentration of the Glycol in the water should be always above 33 vol.%.
- Mixtures with more than 68 vol.% mix ratio in water are not recommended, as this will lead to high engine operating temperatures.
- A refractometer can be ordered from Atlas Copco with part number 2913 0028 00.



**In case of a mix of different coolant products this type of measurement might provide incorrect values.**

### 5.4.3.2 Topping up of coolant

- Verify if the engine cooling system is in a good condition (no leaks, clean,...).
- Check the condition of the coolant.
- If the condition of the coolant is outside the limits, the complete coolant should be replaced (see chapter “Replacing the coolant”).
- Always top-up with PARCOOL EG.
- Topping up the coolant with water only, changes the concentration of additives and is therefore not allowed.

### 5.4.3.3 Replacing the coolant

#### Drain

- Completely drain the entire cooling system.
- Used coolant must be disposed or recycled in accordance with laws and local regulations.

#### Flush

- Flush twice with clean water. Used coolant must be disposed or recycled in accordance with laws and local regulations.
- From the Atlas Copco Instruction book, determine the amount of PARCOOL EG required and pour into the radiator top tank.
- It should be clearly understood that the risk for contamination is reduced in case of proper cleaning.
- In case a certain content of 'other' coolant remains in the system, the coolant with the lowest properties influences the quality of the 'mixed' coolant.

#### Fill

- To assure proper operation and the release of trapped air, run the engine until normal engine operation temperature is reached. Turn off the engine and allow to cool.
- Recheck coolant level and add if necessary.

### 5.4.4 Air filter check



The Atlas Copco air filters are specially designed for the application.

Using only genuine parts will prolong engine life and avoid breakdowns.

Never run the generator set without air filter element.



The engine must be stopped before cleaning or performing any maintenance activity to the air filter (1).

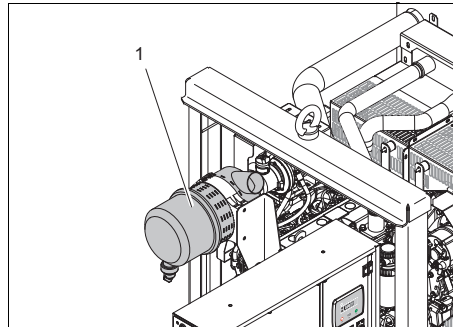

#### 5.4.4.1 Main parts

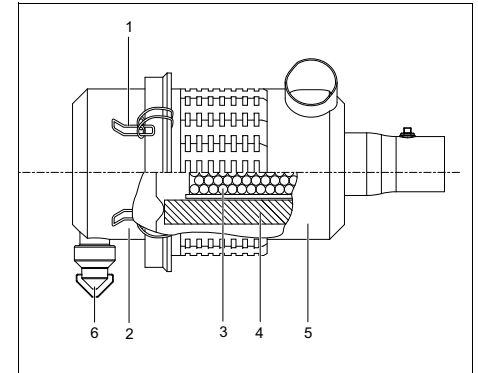

- |   |  |                  |
|---|--|------------------|
| 1 |  | Snap clips       |
| 2 |  | Dust trap        |
| 3 |  | Safety cartridge |
| 4 |  | Filter element   |
| 5 |  | Filter housing   |
| 6 |  | Dust evacuator   |

#### 5.4.4.2 Recommendation

- New elements must be inspected for tears or punctures before installation.
- Discard the filter element (4) when damaged.
- In heavy duty applications it is recommended to install a safety cartridge which can be ordered with part no.: 2914 9307 00.
- A dirty safety cartridge (3) is an indication of a malfunctioning air filter element (4). Replace the element and the safety cartridge in this case.
- The safety cartridge (3) cannot be cleaned.

#### 5.4.4.3 Cleaning the dust trap

To remove dust from the dust trap (2), clean it with a dry rag.

#### 5.4.4.4 Replacing the air filter element

- Release the snap clips (1) and remove the dust trap (2). Clean the trap.
- Remove the element (4) from the housing (5).
- Reassemble in reverse order of dismantling.
- Inspect and tighten all air intake connections.
- Reset the vacuum indicator.

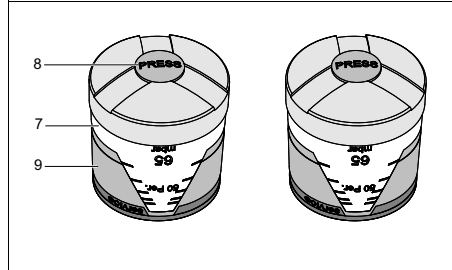

- 7 | Air filter contamination indicator
- 8 | Reset button
- 9 | Yellow indicator

#### 5.4.5 Replacing fuel filter

The engines of the QES units are equipped with a primary fuel filter (1) and a secondary fuel filter (2). Both fuel filters are to be replaced simultaneously at a 500 hours interval, as indicated in the “Maintenance schedule”.

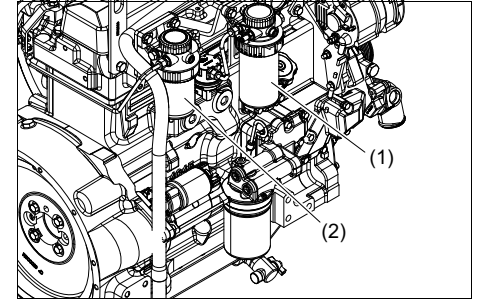

**Fluid escaping under pressure can penetrate the skin causing serious injury. Therefore:**

- Relieve pressure before disconnecting fuel or other lines.
- Tighten all connections before applying pressure.
- Keep hands and body away from pinholes and nozzles which eject fluids under high pressure.
- Use a piece of cardboard or paper to search for leaks, do not use your hand.





**If any fluid is injected into the skin, it must be surgically removed within a few hours by a doctor familiar with this kind of injury or gangrene may result.**

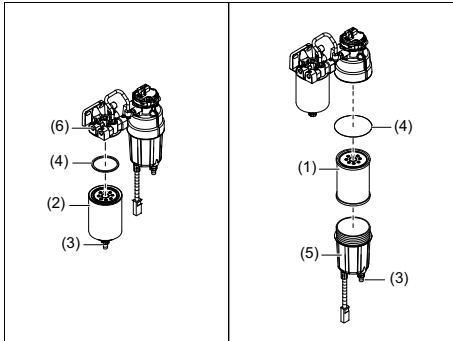

To replace the fuel filter:

1. Close the fuel shut-off valve, if equipped.
2. Thoroughly clean the fuel filter assemblies and surrounding areas.
3. Disconnect the water sensor wiring (if equipped).
4. Loosen the drain plugs (3) and drain the fuel into a suitable container.
5. Firmly grasp the retaining ring (4) and rotate it 1/4 turn clockwise to get it past raised locators when lifting.
6. Remove the ring with the filter element.
7. Inspect the filter mounting base (6) for cleanliness. Clean if required.

8. Make sure that raised locators on the fuel filter canisters are indexed properly with the slots in the mounting base for correct installation.
9. Install the new filter elements onto the mounting bases. Ensure the elements are properly indexed and firmly seated on the bases. It may be necessary to rotate the filters for correct alignment.
10. If a water separator (5) is provided, remove it from the old filter element. Drain and clean the water separator and dry it with compressed air. Install the water separator onto the new element and tighten it securely.
11. Align the keys on the filter element with the slots in the filter base.
12. Install the retaining ring onto the mounting base making sure the dust seal is in place on the filter base.
13. Hand tighten the ring counter clockwise (about 1/3 turn) until it snaps into the detent. DO NOT overtighten the retaining ring. The proper installation is indicated when a “click” is heard and release of the retaining ring is felt.
14. Put the drain plug provided with the new element, into the used element.
15. Reconnect the water sensor wiring (if equipped).
16. Open the shut-off valve and bleed the fuel system.

## 5.4.6 Bleeding the fuel system

Every time the fuel system has been opened up for service (lines disconnected or filters), it is necessary to bleed air from the system.



**High-pressure fluid remaining in the fuel lines can cause serious injury. Do not disconnect or attempt to repair fuel lines, sensors or any other component between the high-pressure fuel pump and nozzles on engines with High Pressure Common Rail (HPCR) fuel system. Only technicians familiar with this type of system can perform repairs.**



**Protect hands and body from high pressure fluids. If an accident occurs, see a doctor immediately.**



**Prevent fuel contamination. Do not crack any fuel lines to bleed the fuel system.**

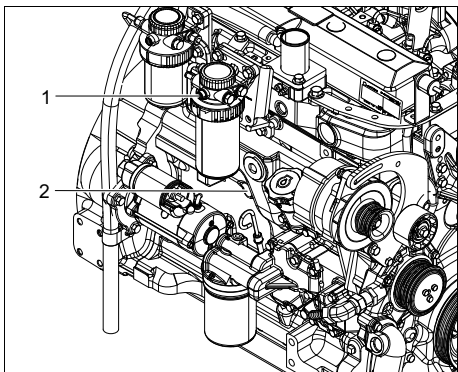

To bleed the fuel system:

1. Loosen the air bleed vent screw (1) two full turns by hand on the fuel filter base.
2. Operate the fuel supply pump primer lever (2), or the primer button on the fuel filter base (if equipped), until fuel flows out of the bleed vent screw.
3. Tighten the bleed vent screw securely. Continue operating the primer until the pumping action is no longer felt.
4. Start the engine and check for leaks.  
If the engine does not start, repeat steps 1 to 3.

## 5.5 Adjustments and service procedures

### 5.5.1 Battery care



**Before handling batteries, read the relevant safety precautions and act accordingly.**

If the battery is still dry, it must be activated as described in chapter “Activating a dry-charged battery”.

The battery must be in operation within 2 months from being activated; if not, it needs to be recharged first.

#### 5.5.1.1 Electrolyte



**Read the safety instructions carefully.**

Electrolyte in batteries is a sulphuric acid solution in distilled water.

The solution must be made up before being introduced into the battery.

#### 5.5.1.2 Activating a dry-charged battery

- Take out the battery.
- Battery and electrolyte must be at equal temperature above 10°C.
- Remove cover and/or plug from each cell.
- Fill each cell with electrolyte until the level reaches 10 to 15 mm above the plates, or to the level marked on the battery.
- Rock the battery a few times so that possible air bubbles can escape; wait 10 minutes and check the level in each cell once more; if required, add electrolyte.
- Refit plugs and/or cover.
- Place the battery in the generator set.

#### 5.5.1.3 Recharging a battery

Before and after charging a battery, always check the electrolyte level in each cell; if required, top up with distilled water only. When charging batteries, each cell must be open, i.e. plugs and/or cover removed.



**Use a commercial automatic battery charger according to its manufacturer’s instructions.**

Apply with preference the slow charging method and adjust the charge current according to the following rule of thumb: battery capacity in Ah divided by 20 gives safe charging current in Amp.

#### 5.5.1.4 Make-up distilled water

The amount of water evaporating from batteries is largely dependant on the operating conditions, i.e. temperatures, number of starts, running time between start and stop, etc...

If a battery starts to need excessive make-up water, this points to overcharging. Most common causes are high temperatures or a too high voltage regulator setting.

If a battery does not need any make-up water at all over a considerable time of operation, an undercharged battery condition may be caused by poor cable connections or a too low voltage regulator setting.

#### 5.5.1.5 Periodic battery service

- Keep the battery clean and dry.
- Keep the electrolyte level at 10 to 15 mm above the plates or at the indicated level; top up with distilled water only. Never overfill, as this will cause poor performance and excessive corrosion.
- Record the quantity of distilled water added.
- Keep the terminals and clamps tight, clean, and lightly covered with petroleum jelly.
- Carry out periodic condition tests. Test intervals of 1 to 3 months, depending on climate and operating conditions, are recommended.

- If doubtful conditions are noticed or malfunctions arise, keep in mind that the cause may be in the electrical system, e.g. loose terminals, voltage regulator maladjusted, poor performance of generator set, etc...

## 5.5.2 Checking belt tensioner spring tension and belt wear

Belt drive systems equipped with automatic (spring) belt tensioners cannot be adjusted or repaired. The automatic belt tensioner is designed to maintain proper belt tension over the life time of the belt. If the tensioner spring is not within specification, replace the tensioner assembly.

### 5.5.2.1 Checking belt wear

The belt tensioner is designed to operate within the limit of arm movement provided by the cast stops (A, B) when correct belt length and geometry is used.

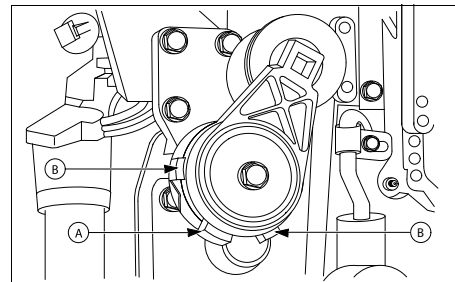

- Visually inspect the cast stops (A and B) on the belt tensioner assembly.
- If the tensioner stop on the swing arm (A) is hitting the fixed stop (B), check the mounting brackets (alternator, belt tensioner, idler pulley, etc.) and the belt length.
- Replace the belt as specified in “Replacing fan and alternator belts”, if required.

### 5.5.2.2 Checking tensioner spring tension

A belt tension gauge will not give an accurate measurement of the belt tension when an automatic spring tensioner is used. Measure the tensioner spring tension using a torque wrench, following the procedure below:

1. Release the tension on the belt by using a long-handled 1/2" drive tool in the square hole on the tensioner arm. Remove the belt from the pulleys.
2. While the belt is removed, inspect pulleys and bearings. Rotate and check for hard turning or any unusual sounds. If pulleys or bearings need replacement, contact Atlas Copco.
3. Release tension on the tensioner arm and remove the drive tool.
4. Put a mark (A) on the swing arm of the tensioner as shown below:

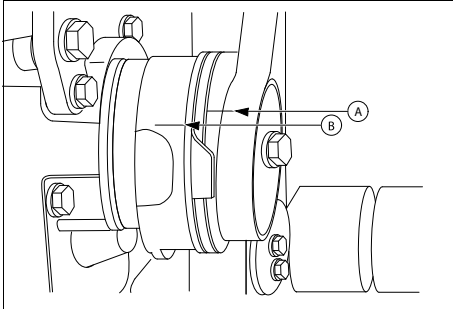

5. Measure 21 mm (0.83 inch) from (A) and put a mark (B) on the tensioner mounting base.

6. Install the torque wrench so that it is aligned with the centres of the pulley and the tensioner.

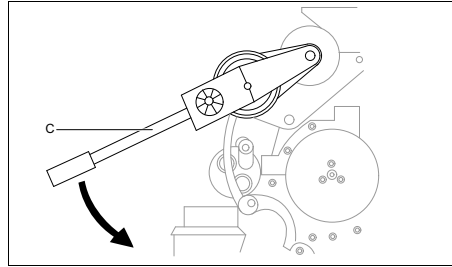

7. Rotate the swing arm using a torque wrench until marks (A and B) are aligned.

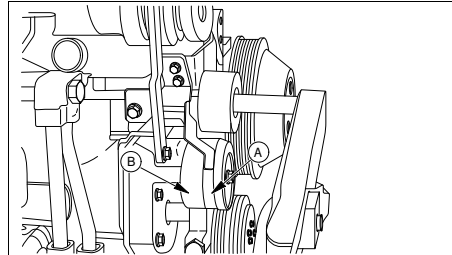

8. Record the torque wrench measurement and compare with the following specifications:  
Spring tension: torque 18-22N•m (13-16 lb-ft)
9. Replace the tensioner assembly as required.



**Threads on the belt tensioner roller cap screw are left-hand threads.**

### 5.5.2.3 Replacing fan and alternator belts

1. To replace a belt with **automatic** tensioner, release the tension on the belt using a breaker bar and socket on the tension arm.

To replace a belt with **manual** tensioner, release tension at the belt tensioner.

2. Remove the poly-V belt from the pulleys and discard the belt.
3. While the belt is removed, inspect pulleys and bearings. Rotate and check for hard turning or any unusual sounds. If pulleys or bearings need replacement, contact Atlas Copco.
4. Install a new belt, making sure the belt is correctly seated in all pulley grooves. Refer to the belt routing below:

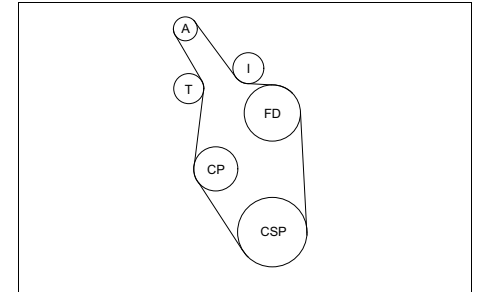

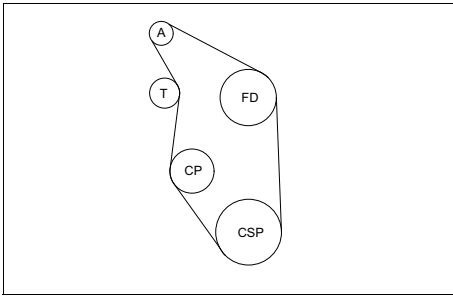

5. Apply tension to the belt with the tensioner. Remove the socket.
6. Install the fan guard, if removed.
7. Start the engine and check the belt alignment.

### 5.5.3 Measuring the valve clearance

- Intake valve clearance for adjusting (rocker arm-to-valve tip) (engine cold):  
Clearance: 0.36 mm (0.014 inch)
- Exhaust valve clearance for adjusting (rocker arm-to-valve tip) (engine cold):  
Clearance: 0.46 mm (0.018 inch)
- Rocker arm adjusting screw jam nut:  
Torque: 27 N•m (20 lb-ft)

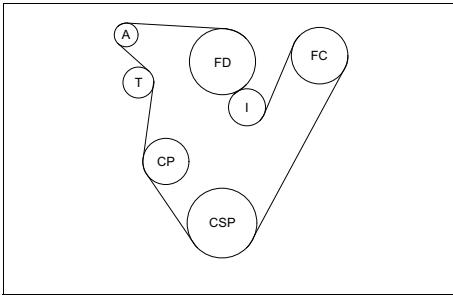

A	Alternator
CSP	Crankshaft pulley
FC	Freon (A/C) compressor
FD	Fan drive
I	Idler pulley
T	Tensioner
CP	Coolant pump

## 5.6 Engine consumable specifications

### 5.6.1 Engine fuel specifications

For fuel specifications, please contact your Atlas Copco Customer Center.

### 5.6.2 Engine oil specifications



The engines of the QES S3A generator set range are supplied from the factory with John Deere engine break-in oil. Run the QES generator set for at least the first 100 hours and up to 500 hours using this oil. The oil is synthetic and can be used at low ambient temperatures, so the oil in the cold start kit should not be replaced. It is strongly recommended to use Atlas Copco branded lubrication oils afterwards.

High-quality, mineral, hydraulic or synthesized hydrocarbon oil with rust and oxidation inhibitors, anti-foam and anti-wear properties is recommended. The viscosity grade should correspond to the ambient temperature and ISO 3448, as follows:

Engine	Type of lubricant
between -10°C and 50°C	PAROIL E or PAROIL E Mission Green
between -25°C and 50°C	PAROIL Extra



**Never mix synthetic with mineral oil.**

**When changing from mineral to synthetic oil (or the other way around), you will need to do an extra rinse.**

**After doing the complete change procedure to synthetic oil, run the unit for a few minutes to allow good and complete circulation of the synthetic oil. Then drain the synthetic oil again and fill again with new synthetic oil. To set correct oil levels, proceed as in normal instruction.**

### Specifications PAROIL

PAROIL from Atlas Copco is the ONLY oil tested and approved for use in all engines built into Atlas Copco compressors and generator sets.

Extensive laboratory and field endurance tests on Atlas Copco equipment have proven PAROIL to match all lubrication demands in varied conditions. It meets stringent quality control specifications to ensure your equipment will run smoothly and reliably.

The quality lubricant additives in PAROIL allow for extended oil change intervals without any loss in performance or longevity.

PAROIL provides wear protection under extreme conditions. Powerful oxidation resistance, high chemical stability and rust-inhibiting additives help reduce corrosion, even within engines left idle for extended periods.

PAROIL contains high quality anti-oxidants to control deposits, sludge and contaminants that tend to build up under very high temperatures.

PAROIL's detergent additives keep sludge forming particles in a fine suspension instead of allowing them to clog your filter and accumulate in the valve/rocker cover area.

PAROIL releases excess heat efficiently, whilst maintaining excellent bore-polish protection to limit oil consumption.

PAROIL has an excellent Total Base Number (TBN) retention and more alkalinity to control acid formation.

PAROIL prevents Soot build-up.

PAROIL is optimized for the latest low emission EURO -3 & -2, EPA TIER II & III engines running on low sulphur diesel for lower oil and fuel consumption.

#### PAROIL Extra

PAROIL Extra is a synthetic ultra high performance diesel engine oil with a high viscosity-index. Atlas Copco PAROIL Extra is designed to provide excellent lubrication from start-up in temperatures as low as -25°C (-13°F).

	Litre	US gal	Imp gal	cu.ft	Order number
can	5	1.3	1.1	0.175	1630 0135 01
can	20	5.3	4.4	0.7	1630 0136 01

#### PAROIL E

PAROIL E is a mineral based high performance diesel engine oil with a high viscosity-index. Atlas Copco PAROIL E is designed to provide a high level of performance and protection in standard ambient conditions as from -10°C (14°F).

	Litre	US gal	Imp gal	cu.ft	Order number
can	5	1.3	1.1	0.175	1615 5953 00
can	20	5.3	4.4	0.7	1615 5954 00
barrel	209	55.2	46	7.32	1615 5955 00
barrel	1000	264	220	35	1630 0096 00

#### PAROIL E Mission Green

PAROIL E Mission Green is a mineral based high performance diesel engine oil with a high viscosity-index. Atlas Copco PAROIL E Mission Green is designed to provide a high level of performance and protection in standard ambient conditions as from -10°C (14°F).

	Litre	US gal	Imp gal	cu.ft	Order number
can	5	1.3	1.1	0.175	1630 0471 00
can	20	5.3	4.4	0.7	1630 0472 00
barrel	209	55.2	46	7.32	1630 0473 00

### 5.6.3 Engine coolant specifications



**Never remove the cooling system filler cap while coolant is hot.**

**The system may be under pressure. Remove the cap slowly and only when coolant is at ambient temperature. A sudden release of pressure from a heated cooling system can result in personal injury from the splash of hot coolant.**

**It is strongly recommended to use Atlas Copco branded coolant.**

The use of the correct coolant is important for good heat transfer and protection of liquid-cooled engines. Coolants used in these engines must be mixtures of good quality water (distilled or de-ionised), special coolant additives and if necessary freeze protection. Coolant that is not to manufacturer's specification will result in mechanical damage of the engine.

The freezing point of the coolant must be lower than the freezing point that can occur in the area. The difference must be at least 5°C. If the coolant freezes, it may crack the cylinder block, radiator or coolant pump.

Consult the engine's operation manual and follow the manufacturer's directions.



**Never mix different coolants and mix the coolant components outside the cooling system.**

## Specifications PARCOOL EG

PARCOOL EG is the only coolant that has been tested and approved by all engine manufacturers currently in use in Atlas Copco compressors and generator sets.

Atlas Copco's PARCOOL EG extended life coolant is the new range of organic coolants purpose designed to meet the needs of modern engines. PARCOOL EG can help prevent leaks caused by corrosion. PARCOOL EG is also fully compatible with all sealants and gasket types developed to join different materials used within an engine.

PARCOOL EG is a ready to use Ethylene Glycol based coolant, premixed in an optimum 50/50 dilution ratio, for antifreeze protection guaranteed to -40°C.

Because PARCOOL EG inhibits corrosion, deposit formation is minimized. This effectively eliminates the problem of restricted flow through the engine coolant ducts and the radiator, minimizing the risk for engine overheating and possible failure.

It reduces water pump seal wear and has excellent stability when subjected to sustained high operating temperatures.

PARCOOL EG is free of nitride and amines to protect your health and the environment. Longer service life reduces the amount of coolant produced and needing disposal to minimise environmental impact.

## PARCOOL EG

	Litre	US gal	Imp gal	cu.ft	Order number
can	5	1.3	1.1	0.175	1604 5308 01
can	20	5.3	4.4	0.7	1604 5307 02
barrel	210	55.2	46	7.35	1604 5306 01

## PARCOOL EG CONCENTRATE

	Litre	US gal	Imp gal	cu.ft	Order number
can	5	1.3	1.1	0.175	1604 8159 00

To ensure protection against corrosion, cavitation and formation of deposits, the concentration of the additives in the coolant must be kept between certain limits, as stated by the manufacturer's guidelines. Topping up the coolant with water only, changes the concentration and is therefore not allowed.

Liquid-cooled engines are factory-filled with this type of coolant mixture.



## 6 Checks and trouble shooting



Never perform a test run with connected power cables. Never touch an electrical connector without a voltage check.

When a failure occurs, always report what you experienced before, during and after the failure. Information with regard to the load (type, size, power factor, etc.), vibrations, exhaust gas colour, insulation check, odours, output voltage, leaks and damaged parts, ambient temperature, daily and normal maintenance and altitude might be helpful to quickly locate the problem. Also report any information regarding the humidity and location of the generator set (e.g. close to sea).

### 6.1 Engine troubleshooting

The list below gives an overview of the possible engine problems and their possible causes.

#### The starter motor turns the engine too slowly

- Battery capacity too low.
- Bad electrical connection.
- Fault in starter motor.
- Wrong grade of lubricating oil.

#### The engine does not start or is difficult to start

- Starter motor turns engine too slowly.
- Fuel tank empty.
- Fault in fuel control solenoid.
- Restriction in a fuel pipe.
- Fault in fuel lift pump.
- Dirty fuel filter element.
- Air in fuel system.
- Fault in atomisers.
- Cold start system used incorrectly.
- Fault in cold start system.
- Restriction in fuel tank vent.
- Wrong type or grade of fuel used.
- Restriction in exhaust pipe.

#### Not enough power

- Restriction in a fuel pipe.
- Fault in fuel lift pump.
- Dirty fuel filter element.
- Restriction in air filter/cleaner or induction system.
- Air in fuel system.
- Fault in atomisers or atomisers of an incorrect type.
- Restriction in fuel tank vent.
- Wrong type or grade of fuel used.
- Restricted movement of engine speed control.
- Restriction in exhaust pipe.
- Engine temperature is too high.
- Engine temperature is too low.

#### Misfire

- Restriction in a fuel pipe.
- Fault in fuel lift pump.
- Dirty fuel filter element.
- Air in fuel system.
- Fault in atomisers or atomisers of an incorrect type.
- Fault in cold start system.
- Engine temperature is too high.
- Incorrect valve tip clearances.

**The pressure of the lubricating oil is too low**

- Wrong grade of lubricating oil.
- Not enough lubricating oil in sump.
- Defective gauge.
- Dirty lubricating oil filter element.

**High fuel consumption**

- Restriction in air filter/cleaner or induction system.
- Fault in atomisers or atomisers of an incorrect type.
- Fault in cold start system.
- Wrong type or grade of fuel used.
- Restricted movement of engine speed control.
- Restriction in exhaust pipe.
- Engine temperature is too low.
- Incorrect valve tip clearances.

**Black exhaust smoke**

- Restriction in air filter/cleaner or induction system.
- Fault in atomisers or atomisers of an incorrect type.
- Fault in cold start system.
- Wrong type or grade of fuel used.
- Restriction in exhaust pipe.
- Engine temperature is too low.

- Incorrect valve tip clearances.
- Engine overload.

**Blue or white exhaust smoke**

- Wrong grade of lubricating oil.
- Fault in cold start system.
- Engine temperature is too low.

**The engine knocks**

- Fault in fuel lift pump.
- Fault in atomisers or atomisers of an incorrect type.
- Fault in cold start system.
- Wrong type or grade of fuel used.
- Engine temperature is too high.
- Incorrect valve tip clearances.

**The engine runs erratically**

- Fault in fuel control.
- Restriction in a fuel pipe.
- Fault in fuel lift pump.
- Dirty fuel filter element.
- Restriction in air filter/cleaner or induction system.
- Air in fuel system.
- Fault in atomisers or atomisers of an incorrect type.

- Fault in cold start system.
- Restriction in fuel tank vent.
- Restricted movement of engine speed control.
- Engine temperature is too high.
- Incorrect valve tip clearances.

**Vibration**

- Fault in atomisers or atomisers of an incorrect type.
- Restricted movement of engine speed control.
- Engine temperature is too high.
- Fan damaged.
- Fault in engine mounting or flywheel housing.

**The pressure of the lubricating oil is too high**

- Wrong grade of lubricating oil.
- Defective gauge.

**The engine temperature is too high**

- Restriction in air filter/cleaner or induction system.
- Fault in atomisers or atomisers of an incorrect type.
- Fault in cold start system.
- Restriction in exhaust pipe.
- Fan damaged.
- Too much lubricating oil in sump.
- Restriction in air or coolant passages of radiator.

**Crankcase pressure**

- Restriction in breather pipe.
- Vacuum pipe leaks or fault in exhaust.

**Bad compression**

- Restriction in air filter/cleaner or induction system.
- Incorrect valve tip clearances.

**The engine starts and stops**

- Dirty fuel filter element.
- Restriction in air filter/cleaner or induction system.
- Air in fuel system.

**The engine shuts down after approx. 15 sec.**

- Bad connection towards oil pressure switch/ coolant temperature switch.

## 6.2 Alternator troubleshooting

<i>Symptom</i>	<i>Possible cause</i>	<i>Corrective action</i>
<i>Alternator gives 0 Volt</i>	Blown fuse. No residual voltage.	Replace fuse. Excite the alternator by applying a 12V battery voltage with a 30 $\Omega$ resistor in series on the + and - terminals of the electronic regulator, respecting the polarities.
<i>After being excited the alternator still gives 0 Volt.</i>	Connections are interrupted.	Check connection cables, measure winding resistance and compare with values mentioned in the alternator manual.
<i>Low voltage at no load</i>	Voltage potentiometer out of setting. Intervention of protection. Winding failure.	Reset voltage. Check frequency/voltage regulator. Check windings.
<i>High voltage at no load</i>	Voltage potentiometer out of setting. Failed regulator.	Reset voltage. Substitute regulator.
<i>Lower than rated voltage at load</i>	Voltage potentiometer out of setting. Intervention by protection.  Failed regulator. Rotating bridge failure.	Reset voltage potentiometer. Current too high, power factor lower than 0.8; speed lower than 10% of rated speed. Substitute regulator. Check diodes, disconnect cables.
<i>Higher than rated voltage at load</i>	Voltage potentiometer out of setting. Failed regulator.	Reset voltage potentiometer. Substitute regulator.
<i>Unstable voltage</i>	Speed variation in engine. Regulator out of setting.	Check regularity of rotation. Regulate stability of regulator by acting on STABILITY potentiometer.

## 6.3 Solving Qc1111™/Qc2111™ controller alarms

### 6.3.1 Qc1111™/Qc2111™ alarms and remedies

If an alarm condition occurs, an icon is displayed in the Alarm icon section of the LCD to indicate the alarm that is current active on the controller.

In the event of a **warning alarm**, the LCD only displays the Alarm Icon.

In the event of an **electrical trip or shutdown alarm**, the module displays the Alarm icon and the STOP/RESET button LED begins to flash.

If multiple alarms are active at the same time, the Alarm icon automatically cycles through all the appropriate icons to indicate each alarm which is active.

Example:



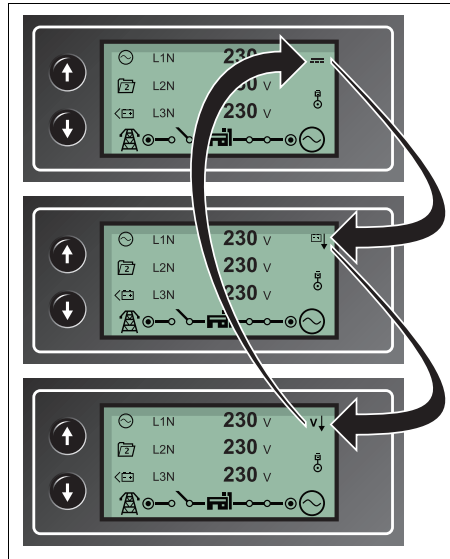





If the Qc1111™/Qc2111™ controller detected a charge alternator failure alarm, a delay over current alarm and an AC under voltage alarm at the same time, it would cycle through all of the icons, as shown below:















## 6.3.2 Alarm overview

### 6.3.2.1 Warning alarm icons

Warnings are non-critical alarm conditions and do not affect the operation of the generator set system, they serve to draw the operators attention to an undesirable condition. By default, warning alarms are self-resetting when the fault condition is removed. However enabling “all warnings are latched” will cause warning alarms to latch until reset manually.

Display	Description	Reason
	Auxiliary Inputs	The module detects that an auxiliary input which has been user configured to create a fault condition has become active.
	Analogue Input Configured As Digital	The analogue inputs can be configured to digital inputs. The module detects that an input configured to create a fault condition has become active.
	Fail to stop	The module has detected a condition that indicates that the engine is running when it has been instructed to stop.  <b>‘Fail to Stop’ could indicate a faulty oil pressure sensor. If the engine is at rest, check the oil sensor wiring and configuration.</b>
	Charge Failure	The auxiliary charge alternator voltage is low as measured from the W/L terminal.
	Low Fuel Level	The level detected by the fuel level sensor is below the low fuel level pre-set pre-alarm setting.
	High Fuel Level	The level detected by the fuel level sensor is above the high fuel level pre-set pre-alarm setting.
	Battery Under Voltage	The DC supply has fallen below or risen above the low volts pre-set pre-alarm setting.

Display	Description	Reason
	Battery Over Voltage	The DC supply has risen above the high volts pre-set pre-alarm setting.
	Generator Under Voltage	The generator output voltage has fallen below the pre-set pre-alarm setting after the Safety On timer has expired.
	Generator Over Voltage	The generator output voltage has risen above the pre-set pre-alarm setting.
	Generator Under Frequency	The generator output frequency has fallen below the pre-set pre-alarm setting after the Safety On timer has expired.
	Generator Over Frequency	The generator output frequency has risen above the pre-set pre-alarm setting.
	CAN ECU Fault	The engine ECU has detected an alarm.
	CAN Data Fail	The module is configured for CAN operation and does not detect data on the engine CAN data link.
	Immediate Over Current	The measured current has risen above the configured trip level.
	Delayed Over Current	The measured current has risen above the configured trip level for a configured duration.
	Oil Filter Maintenance Alarm	Maintenance due for oil filter

Display	Description	Reason
	Air Filter Maintenance Alarm	Maintenance due for air filter
	Fuel Filter Maintenance Alarm	Maintenance due for fuel filter









### 6.3.2.2 Electrical trip alarm icons

Electrical trips are latching and stop the generator set, but in a controlled manner. On initiation of the electrical trip condition the Qc1111™ /Qc2111™ module de-energises all the ‘Delayed Load Output’ and the ‘Close Gen Output’ outputs to remove the load from the generator set. Once this has occurred the module starts the Cooling timer and allows the engine to cool off-load before shutting down the engine. The alarm must be accepted and cleared, and the fault removed to reset the module.

Electrical trips are latching alarms and to remove the fault, press the STOP/RESET button on the Qc1111™ /Qc2111™ module.



**The alarm condition must be rectified before a reset will take place. If the alarm condition remains, it is not possible to reset the unit.**

Display	Description	Reason
	Auxiliary Inputs	The module detects that an auxiliary input which has been user configured to create a fault condition has become active.
	Analogue Input Configured As Digital	The analogue inputs can be configured to digital inputs. The module detects that an input configured to create a fault condition has become active.
	Low Fuel Level	The level detected by the fuel level sensor is below the low fuel level pre-set alarm setting.
	High Fuel Level	The level detected by the fuel level sensor is above the high fuel level pre-set alarm setting.
	Delayed Over Current	The measured current has risen above the configured trip level for a configured duration.
	kW Overload	The measured kW has risen above the configured trip level for a configured duration.







### 6.3.2.3 Shutdown alarm icons











Shutdown alarms are latching and immediately stop the generator set. On initiation of the shutdown condition the module de-energises all the ‘Delayed Load Output’ and the ‘Close Gen Output’ outputs to remove the load from the generator set. Once this has occurred, the module shuts the generator set down immediately to prevent further damage. The alarm must be accepted and cleared, and the fault removed to reset the module.







Shutdowns are latching alarms and to remove the fault, press the STOP/RESET button on the Qc1111™ /Qc2111™ module.



**The alarm condition must be rectified before a reset will take place. If the alarm condition remains, it is not possible to reset the unit.**

Display	Description	Reason
	Auxiliary Inputs	The module detects that an auxiliary input which has been user configured to create a fault condition has become active.
	Analogue Input Configured As Digital	The analogue inputs can be configured to digital inputs. The module detects that an input configured to create a fault condition has become active.
	Fail To Start	The engine has failed to start after the configured number of start attempts.
	Low Oil Pressure	The module detects that the engine oil pressure has fallen below the low oil pressure pre-alarm setting level after the Safety On timer has expired.
	Engine High Temperature	The module detects that the engine coolant temperature has exceeded the high engine temperature pre-alarm setting level after the Safety On timer has expired.
	Under Speed	The engine speed has fallen below the under speed pre-alarm setting.
	Over Speed	The engine speed has risen above the over speed pre-alarm setting.

Display	Description	Reason
	Charge Failure	The auxiliary charge alternator voltage is low as measured from the W/L terminal.
	Low Fuel Level	The level detected by the fuel level sensor is below the low fuel level pre-set alarm setting.
	High Fuel Level	The level detected by the fuel level sensor is above the high fuel level pre-set alarm setting.
	Generator Under Voltage	The generator output voltage has fallen below the pre-set alarm setting. after the Safety On timer has expired.
	Generator Over Voltage	The generator output voltage has risen above the pre-set alarm setting.
	Generator Under Frequency	The generator output frequency has fallen below the pre-set alarm setting after the Safety On timer has expired.
	Generator Over Frequency	The generator output frequency has risen above the pre-set alarm setting.
	Delayed Over Current	The measured current has risen above the configured trip level for a configured duration.
	kW Overload	The measured kW has risen above the configured trip level for a configured duration.
	CAN ECU Fault	The engine ECU has detected an alarm – CHECK ENGINE LIGHT. Contact Engine Manufacturer for support.

Display	Description	Reason
 CAN	CAN Data Fail	The module is configured for CAN operation and does not detect data on the engine CAN data link.
	Emergency Stop	The emergency stop button has been depressed. This failsafe (normally closed to emergency stop) input immediately stops the set, should the signal be removed.
	Oil Sender Open Circuit	The oil pressure sensor has been detected as being open circuit.
	Coolant Temperature Sender Open Circuit	The coolant temperature sensor has been detected as being open circuit.
	Oil Filter Maintenance Alarm	Maintenance due for oil filter.
	Air Filter Maintenance Alarm	Maintenance due for air filter.
	Fuel Filter Maintenance Alarm	Maintenance due for fuel filter.

## **7 Storage of the generator set**

### **7.1 Storage**

- Store the generator set in a dry, frost-free room which is well ventilated.
- Run the engine regularly, e.g. once a week, until it is warmed up. If this is impossible, extra precautions must be taken:
  - Consult the engine's operator manual.
  - Remove the battery. Store it in a dry, frost-free room. Keep the battery clean and its terminals lightly covered with petroleum jelly. Recharge the battery regularly.
  - Clean the generator set and protect all electrical components against moisture.
  - Place silica gel bags, VCI paper (Volatile Corrosion Inhibitor) or another drying agent inside the generator set and close the doors.
  - Stick sheets of VCI paper with adhesive tape on the bodywork to close off all openings.
  - Wrap the generator set, except the bottom, with a plastic bag.

### **7.2 Preparing for operation after storage**

Before operating the generator set again, remove the wrapping, VCI paper and silica gel bags and check the generator set thoroughly (go through the checklist "Before starting" on page 25).

- Consult the engine's operator manual.
- Check that the insulation resistance of the generator set exceeds 2 MΩ.
- Replace the fuel filter and fill the fuel tank. Vent the fuel system.
- Reinstall and connect the battery, if necessary after being recharged.
- Submit the generator set to a test run.

## 8 Disposal

### 8.1 General

When developing products and services, Atlas Copco tries to understand, address, and minimize the negative environmental effects that the products and services may have, when being manufactured, distributed, and used, as well as at their disposal.

Recycling and disposal policy are part of the development of all Atlas Copco products. Atlas Copco company standards determine strict requirements.

Selecting materials the substantial recyclability, the disassembly possibilities and the separability of materials and assemblies are considered as well as the environmental perils and dangers to health during the recycling and disposal of the unavoidable rates of not recyclable materials.

Your Atlas Copco generator set consists for the most part of metallic materials, that can be remelted in steelworks and smelting works and that is therefore almost infinite recyclable. The plastic used is labelled; sorting and fractioning of the materials for recycling in the future is foreseen.



**This concept can only succeed with your help. Support us by disposing professionally. By assuring a correct disposal of the product you help to prevent possible negative consequences for environment and health, that can occur with an inappropriate waste handling.**

**Recycling and re-usage of material helps to preserve natural resources.**

### 8.2 Disposal of materials

Dispose contaminated substances and material separately, according to local applicable environmental legislation.

Before dismantling a machine at the end of its operating lifetime drain all fluids and dispose of according the applicable local disposal regulations.

Remove the batteries. Do not throw batteries into the fire (explosion risk) or into the residual waste. Separate the machine into metal, electronics, wiring, hoses, insulation and plastic parts.

Dispose all components according to the applicable disposal regulations.

Remove spilled fluid mechanically; pick up the rest with absorbing agent (for example sand, sawdust) and dispose it according the applicable local disposal regulations. Do not drain into the sewage system or surface water.

## 9 Options available

### 9.1 Circuit diagrams

The engine control circuit diagrams and the power circuit diagrams for the standard QES 60-85-105-120-150-200 units, for the units with options and for the units with combined options are:

<i>Unit</i>	<i>Circuit</i>
QES 60 Jd	1636 0112 38
QES 85-105-120-150-200 Jd	1636 0107 80

### 9.2 Overview of the electrical options

The following electrical options are available:

- Automatic battery charger
- Battery switch
- Engine coolant heater
- Air heater for cold start
- Outlet sockets (S) - 3-phase
- IT-relay

### 9.3 Description of the electrical options

#### 9.3.1 Automatic battery charger

The 2 Amp battery chargers have been designed to be permanently connected to a battery, keeping it charged to maximum capacity. The charger will continue to operate during cranking and running. It can accept multiple AC voltage connections.

The LED on the bottom indicates that the unit is operational.

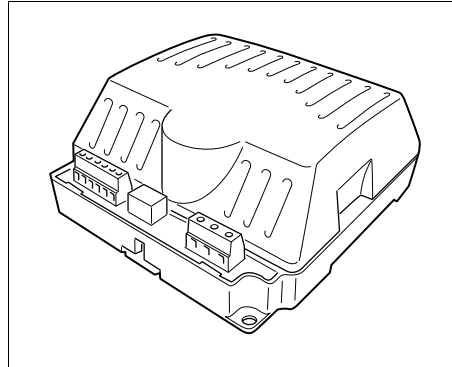

The battery charger provides multi-stage intelligent charging:

- Constant current: maximum current available during charge recovery phase
- Constant voltage
- Chargers automatically return to float mode when charging is complete

It also offers full protection:

- Reverse polarity protection, short circuit protection and current limiting
- Automatic recovery after the removal of fault conditions

To use the battery charger:

- Provide connector X4 with external power:
  - terminals for inlet supply: 832 - 835
  - terminals for outlet: X5.

### 9.3.2 Battery switch

The battery switch is situated inside the sound-insulated bodywork. It allows to open or to close the electrical connection between the battery and the engine circuits.



**Never turn the battery switch to OFF during operation.**

### 9.3.3 Engine coolant heater

To make sure that the engine can start and accept load immediately, an external cooling water heater (1000 W, 240 V) is provided which keeps the engine temperature between 38°C and 49°C.

### 9.3.4 Air heater for cold start

The air heater option ensures engine starts at temperatures as low as -20°C.

On QES 85-105-120-150-200 generator sets the air heater is controlled and operated automatically by the engine ECU. A LED on the control panel indicates that the air preheating is ON and the engine will start as soon as the correct air temperature is reached.

On QES 60 generator sets a push button is provided to regulate the air preheating manually, as described below:

1. Push and hold the air heater button during preheat time (see table below).
2. Release the air heater button and push the START button to start engine.
3. When the engine starts fuel combustion, push and hold the air heater button during reheat time (see table below).
4. Repeat the reheat cycle during 120s. Maintain a 10s time interval between 2 reheating cycles.

Temperature	Preheat time	Reheat time
0 °C	0 s	0 s
-5 °C	10 s	10 s
-10 °C	15 s	15 s
-15 °C	20 s	20 s
-20 °C	30 s	20 s



### 9.3.5 Outlet sockets (S) - 3-phase

A brief description of all outlet sockets and circuit breakers provided on the generator set is given hereafter:

#### *XS1..... 1-phase outlet socket (230/277 V AC)*

Provides phase L1, neutral and earthing.

#### *XS2..... 1-phase outlet socket (230/277 V AC)*

Provides phase L2, neutral and earthing.

#### *XS3..... 3-phase outlet socket (400/480 V AC)*

Provides phases L1, L2 and L3, neutral and earthing.

#### *XS4..... 3-phase outlet socket (400/480 V AC)*

Provides phases L1, L2 and L3, neutral and earthing.

#### *XS5..... 3-phase outlet socket (400/480V AC)*

Provides phases L1, L2 and L3, neutral and earthing.

#### *Q601... Circuit breaker for XS1*

Interrupts the power supply to XS1 when a short-circuit occurs at the load side, or when the overcurrent protection (16 A) is activated. When tripped, Q601 interrupts phase L1 towards XS1. It can be reset after eliminating the problem.

#### *Q602... Circuit breaker for XS2*

Interrupts the power supply to XS2 when a short-circuit occurs at the load side, or when the overcurrent protection (16 A) is activated. When tripped, Q602 interrupts phase L2 towards XS2. It can be reset after eliminating the problem.

#### *Q603... Circuit breaker for XS3*

Interrupts the power supply to XS3 when a short-circuit occurs at the load side, or when the overcurrent protection (16 A) is activated. When tripped, Q603 interrupts the three phases towards XS3. It can be reset after eliminating the problem.

#### *Q604... Circuit breaker for XS4*

Interrupts the power supply to XS4 when a short-circuit occurs at the load side, or when the overcurrent protection (32 A) is activated. When tripped, Q604 interrupts the three phases towards XS4. It can be reset after eliminating the problem.

#### *Q605... Circuit breaker for XS5*

Interrupts the power supply to XS5 when a short-circuit occurs at the load side, or when the overcurrent protection (63 A) is activated. When tripped, Q605 interrupts the three phases towards XS5. It can be reset after eliminating the problem.

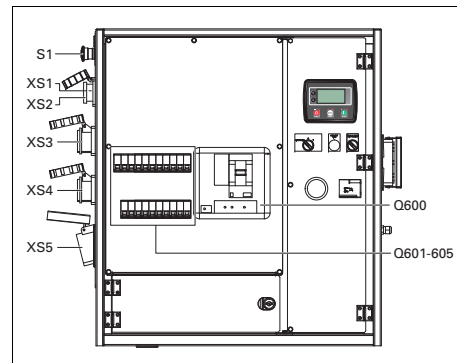

**Circuit breaker Q600 does not only interrupt the power supply towards X10, but also towards XS1, XS2, XS3, XS4 and XS5.**

**Make sure to switch on circuit breakers Q600, Q601, Q602, Q603, Q604 and Q605 after starting the generator set when power is supplied by means of XS1, XS2, XS3, XS4 or XS5.**

### 9.3.6 Dual frequency



**The Dual frequency option is not applicable for QES 60.**

Dual frequency allows the unit to work at 50 Hz or at 60 Hz with an accuracy of constant load. The frequency selection is done by means of switch S3.

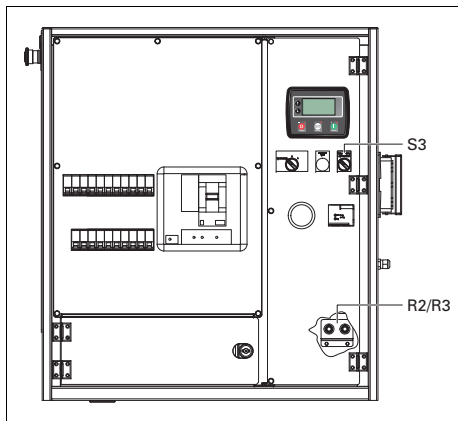

**R2 ..... Voltage adjust potentiometer 50 Hz**

Allows to adjust the output voltage at 50 Hz.

**R3 ..... Voltage adjust potentiometer 60 Hz**

Allows to adjust the output voltage at 60 Hz.

**S3 ..... Frequency selector switch (50 Hz/60 Hz)**

Allows to choose the frequency of the output voltage: 50 Hz or 60 Hz.



**Changing the output frequency is only allowed when the unit has stopped.**

**After changing the output frequency, adjust the output voltage by means of potentiometers R2 or R3 to the required value.**

### 9.3.7 IT-relay

The generator set is wired for an IT network i.e. no supply lines of the power supply are directly earthed. A failure in insulation resulting in a too low insulation resistance, is detected by the insulation monitoring relay.



**The generator set shall not be operated with other networks (such as TT or TN). Doing so will cause tripping of the insulation monitoring relay.**

**The generator set is wired for an IT network i.e. no supply lines of the power supply are directly earthed. A failure in insulation resulting in too low an insulation resistance, is detected by the insulation monitoring relay.**

**At each start-up and any time a new load is connected, the insulation resistance must be verified. Check for the correct setting of the insulation monitoring relay. (factory set at 13 k $\Omega$ )**

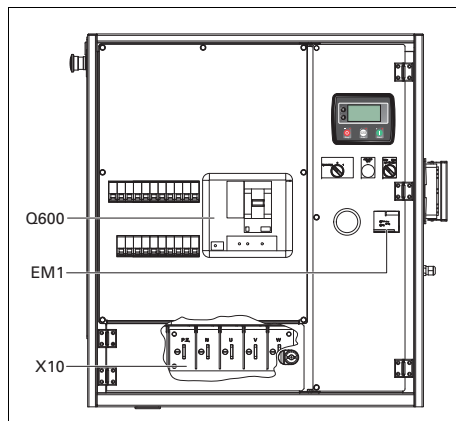

*Q600... Circuit breaker for X10*

Interrupts the power supply X10 when a short-circuit occurs at the load side, or when the overcurrent protection is activated. When activated, Q600 interrupts the three phases towards X10. It must be reset manually after eliminating the problem.

*X10 ..... Main power supply (400 V AC)*

Terminals L1, L2, L3, N (= neutral) and PE (= earthing), hidden behind the control panel door and behind a small transparent door.

*EM1 .... Insulation monitoring relay*

Checks the insulation resistance and activates Q600 when the insulation resistance is too low.

## 9.4 Overview of the mechanical options

The following mechanical options are available:

- External fuel tank connection (with/without quick couplings)
- Oil drain pump
- Undercarriage (axle, towbar, towing eyes)
- Skid frame
- Special colour

## 9.5 Description of the mechanical options

### 9.5.1 External fuel tank connection (with/without quick couplings)

The option external fuel tank connection allows to bypass the internal fuel tank and to connect an external fuel tank to the unit.

#### View outside

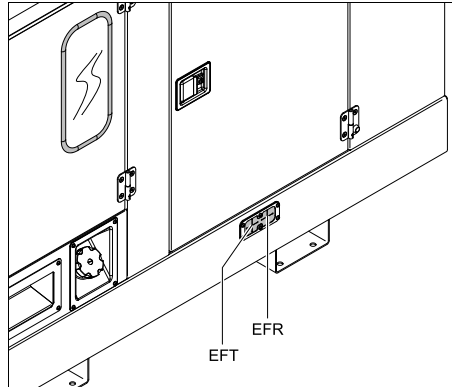

#### View inside

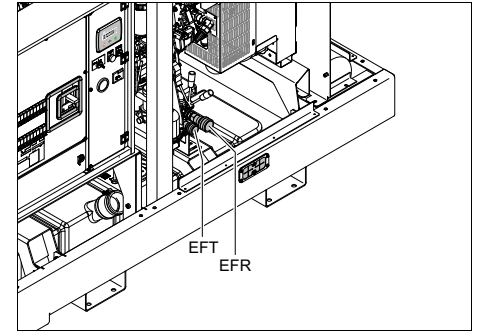

EFT | External fuel tank feed connection  
EFR | External fuel tank return connection

When using this option, make sure to connect the fuel supply line as well as the fuel return line. Connections to fuel lines ought to be air-tight to prevent air from entering the fuel system. Turn the handle of 3-way valve to desired condition.



Position 1: Indicates that the fuel supply line to the engine is connected to the internal fuel tank.

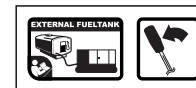

Position 2: Indicates that the fuel supply line to the engine is connected to the external fuel tank.

## 9.5.2 Oil drain pump

The oil drain pump facilitates oil change.

## 9.5.3 Undercarriage (axle, towbar, towing eyes)

The QES Jd generator sets can be optionally provided with a site trailer for off-road use. For on-road use the undercarriage is either equipped with an adjustable or fixed towbar with DIN-eye, NATO-eye, ITA-eye, AFR-eye or ball coupling and with road signalisation which is approved by EC legislation.

### When using this option

- Make sure that the towing equipment of the vehicle matches the towing eye before towing the generator set.
- Never move the generator set while electrical cables are connected to the unit.
- Always apply the hand brake when parking the generator set.
- Leave enough space for operation, inspection and maintenance (at least 1 meter at each side).

### To maintain the undercarriage

- Check the tightness of the towbar bolts, the axle bolts and the wheel nuts at least twice a year and after the initial 50 hours of operation.
- Grease the wheel axle suspension bearings, the drawbar to the steering gear shaft and the spindle of the brake handle at least twice a year. Use ball bearing grease for the wheel bearings and graphite grease for the drawbar and spindle.
- Check the brake system twice a year.
- Check the condition of the vibration dampers twice a year.
- Repack the wheel hub bearings once a year using grease.

## 9.5.4 Skid frame

The skid frame option offers a very solid base frame for use on rough working sites. It can also be used to slide the generator set on short distance. To be able to lift the generator set by means of a forklift, rectangular slots are provided.

## 10 Technical specifications

### 10.1 Technical specifications for QES 60 units

#### 10.1.1 Settings of switches

Switch	Function	Activates at
Engine oil pressure	Shut down	1.0 bar
Engine coolant temperature	Shut down	105°C

#### 10.1.2 Specifications of the engine/alternator/unit

		QES 60 - 50 Hz
<i>Reference conditions 1)</i>	Rated frequency	50 Hz
	Rated speed	1500 rpm
	Generator service duty	PRP
	Absolute air inlet pressure	1 bar(a)
	Relative air humidity	30%
	Air inlet temperature	25°C
<i>Limitations 2)</i>	Maximum ambient temperature	50°C
	Altitude capability	3000 m
	Maximum relative air humidity	85%
	Minimum starting temperature	0°C
	Minimum starting temperature with cold start equipment (optional)	-18°C/-25°C
<i>Performance data 2) 3) 4) 5)</i>	Rated active power (PRP)	48.6 kW
	Rated active power (ESP)	52.8 kW
	Rated apparent power (PRP)	60.7 kVA
	Rated apparent power (ESP)	66.0 kVA
	Rated voltage line to line	400 V
	Rated current	87.6 A
	Performance class (PRP) (acc.ISO 8528-5:1993)	G2
	Single step load acceptance (PRP)	85%
	Frequency droop	41.3 kW < 5%
	Fuel consumption at no load (PRP) (0%)	2.4 kg/h
	Fuel consumption at 50% load (PRP)	7.7 kg/h
	Fuel consumption at 75% load (PRP)	10.1 kg/h
	Fuel consumption at full load (PRP) (100%)	12.0 kg/h

	Specific fuel consumption (at full load PRP, 100%)	0.247 kg/kWh
	Fuel autonomy at full load with standard tank	11,5 h
	Fuel autonomy at full load with 24h tank	37.3 h
	Max. oil consumption at full load	N/A
	Maximum sound power level (Lw) complies with 2000/14 EC	91 dB(A)
	Capacity of standard fuel tank	160 l
	Capacity of 24h fuel tank	520 l
	Single step load capability (PRP)	48.6 kW 100%
<i>Application data</i>	Mode of operation	PRP
	Site	land use
	Operation	single
	Start-up and control mode	manual/automatic
	Start-up time	unspecified
	Mobility/Config. acc. to ISO 8528-1:1993 (optional)	transportable/D mobile/E
	Mounting	fully resilient
	Climatic exposure	open air
<i>Engine 4)</i>	Standard	ISO 3046 ISO 8528-2
	Type John Deere	4045HFG81
	Rated net output (PRP)	54.0 kW
	rating type acc. ISO 3046-7	ICXN
	Coolant	coolant
	Combustion system	direct injection
	Aspiration	turbocharged
	Charged air cooling system	air-to-air aftercooled
	Number of cylinders	4
	Swept volume	4.5 l
	Speed governing	mechanical
	Capacity of oil sump - initial fill	12 l
	Capacity of cooling system	18 l
	Electrical system	12 Vdc
	Emission compliance	EU stage IIIA
	Maximum permissible load factor of PRP during 24h period	70%
<i>Alternator 4)</i>	Standard	IEC34-1 ISO 8528-3
	Make	Mecc Alte
	Model	ECP 32-2M/4 B
	Rated output, class H temp. rise	63 kVA

	rating type acc. ISO 8528-3	125/40°C
	Degree of protection (IP index acc. NF EN 60-529)	IP 23
	Insulation stator class	H
	Insulation rotor class	H
	Number of wires	12
<i>Power circuit</i>	<b>Circuit-breaker</b>	
	Number of poles	4
	Thermal release 50 Hz PRP It (thermal release is higher at 25°C)	100 A (0,8 x In)
	Magnetic release Im	3 x In
	<b>Fault current protection</b>	
	Residual current release IDn	0.030-30 A
	Insulation resistance (optional)	1-200 kOhm
	<b>Outlet sockets (optional)</b>	
		domestic (1x) 2p + PE 16 A 230 V
		domestic (1x) 2p + PE 16 A 230 V
	CEE form (1x) 3p + N + PE 16 A 400 V	
	CEE form (1x) 3p + N + PE 32 A 400 V	
	CEE form (1x) 3p + N + PE 63 A 400 V	
<i>Unit</i>	Dimensions - basic frame (LxWxH)	2228 x 1130 x 1615.0 mm
	Dimensions - basic frame + 24h fuel tank (LxWxH)	2300 x 1130 x 2015.5 mm
	Dimensions - optional skid frame (LxWxH)	2300 x 1130 x 1615.5 mm
	Dimensions - optional skid frame + 24h fuel tank (LxWxH)	2300 x 1130 x 2015.5 mm
	Weight wet mass	1640 kg



**Notes**

- 1) Reference conditions for engine performance to ISO 3046-1.
- 2) See derating diagram or consult the factory for other conditions.
- 3) At reference conditions unless otherwise stated.
- 4) Rating definition (ISO 8528-1):  
 LTP: Limited Time Power is the maximum electrical power which a generating set is capable of delivering (at variable load), in the event of a utility power failure (for up to 500 hours per year of which a maximum of 300 hours is continuous running). No overload is permitted on these ratings. The alternator is peak continuous rated (as defined in ISO 8528-3) at 25°C.  
 ESP: Emergency Standby Power is defined as the maximum power available during a variable electrical power sequence, under the stated operating conditions, for which a generating set is capable of delivering in the event of a utility power outage or under test conditions for up to 200h of operation per year, with the maintenance intervals and procedures being carried out as described by the manufacturers. The permissible average power output ( $P_{pp}$ ) over 24h of operation shall not exceed 70% of the ESP unless otherwise agreed by the engine manufacturer.  
 PRP: Prime Power is the maximum power available during a variable power sequence, which may be run for an unlimited number of hours per year, between stated maintenance intervals and under the stated ambient conditions. A 10% overload is permitted for 1 hour in 12 hours. The permissible average power output during a 24h period shall not exceed the stated load factor as indicated in the Technical Specifications above.
- 5) Specific mass fuel used: 0.86 kg/l.

*Derating factor % - 1500PRP*

Height (m)	Temperature (°C)										
	0	5	10	15	20	25	30	35	40	45	50
0	100	100	100	100	100	100	95	95	95	90	90
500	95	95	95	95	95	95	95	95	90	90	90
1000	95	95	95	95	95	95	95	95	90	90	90
1500	95	95	95	95	95	95	95	90	90	90	90
2000	95	95	95	95	95	95	90	90	90	90	85
2500	90	90	90	90	90	90	85	85	85	NA	NA
3000	90	90	90	90	90	90	85	85	85	NA	NA

*For use of generator set outside these conditions, please contact Atlas Copco.*

## 10.2 Technical specifications for QES 85

### 10.2.1 Settings of switches

Switch	Function	Activates at
Engine oil pressure	Shut down	1.0 bar
Engine coolant temperature	Shut down	110°C

### 10.2.2 Specifications of the engine/alternator/unit

		QES 85 - 50Hz	QES 85 - 60Hz
<i>Reference conditions 1)</i>	Rated frequency	50 Hz	60 Hz
	Rated speed	1500 rpm	1800 rpm
	Generator service duty	PRP	PRP
	Absolute air inlet pressure	1 bar(a)	1 bar(a)
	Relative air humidity	30%	30%
	Air inlet temperature	25°C	25°C
<i>Limitations 2)</i>	Maximum ambient temperature	50°C	50°C
	Altitude capability	3000 m	3000 m
	Maximum relative air humidity	85%	85%
	Minimum starting temperature unaided	0°C	0°C
	Minimum starting temperature with cold start equipment (optional)	-18°C/-25°C	-18°C/-25°C
<i>Performance data 2) 3) 4) 5)</i>	Rated active power (PRP)	66.9 kW	67.0 kW
	Rated active power (ESP)	73.0 kW	74.3 kW
	Rated apparent power (PRP)	83.7 kVA	83.8 kVA
	Rated apparent power (ESP)	91.3 kVA	92.9 kVA
	Rated voltage line to line	400 V	480 V
	Rated current 3ph	120,7 A	100,8 A
	Performance class (acc.ISO 8528-5:1993)	G3	G3
	Single step load acceptance (PRP)	75%	90%
		50.2 kW	60.2 kW
	Frequency droop	isochronous	isochronous
	Fuel consumption at no load (PRP) (0%)	2.2 kg/h	2.9 kg/h
	Fuel consumption at 50% load (PRP)	9.5 kg/h	9.9 kg/h
	Fuel consumption at 75% load (PRP)	13.0 kg/h	13.9 kg/h
	Fuel consumption at full load (PRP) (100%)	15.9 kg/h	17.2 kg/h
	Specific fuel consumption (at full load PRP, 100%)	0.238 kg/kWh	0.257 kg/kWh
	Fuel autonomy at full load with standard tank	12.4 h	11,5 h
	Fuel autonomy at full load with 24h tank	36.8 h	34.0 h

	Max. oil consumption at full load	N/A	N/A
	Maximum sound power level (Lw) complies with 2000/14 EC	89 dB(A)	N/A
	Capacity of standard fuel tank	230 l	230 l
	Capacity of 24h fuel tank	680 l	680 l
	Single step load capability (PRP)	66.9 kW 100%	67 kW 100%
<i>Application data</i>	Mode of operation	PRP	PRP
	Site	land use	land use
	Operation	single	single
	Start-up and control mode	manual/automatic	manual/automatic
	Start-up time	unspecified	unspecified
	Mobility/Config. acc. to ISO 8528-1:1993 (optional)	transportable/D	transportable/D
	Mounting	mobile/E	mobile/E
	Climatic exposure	fully resilient open air	fully resilient open air
<i>Engine 4)</i>	Standard	ISO 3046	ISO 3046
	Type John Deere	ISO 8528-2	ISO 8528-2
	Rated net output (PRP)	4045HFG82_A	4045HFG82_A
	rating type acc. ISO 3046-7	73.1 kW	71.9 kW
	Coolant	ICXN	ICXN
	Combustion system	coolant	coolant
	Aspiration	HPCR	HPCR
	Charged air cooling system	turbocharged	turbocharged
	Number of cylinders	air-to-air aftercooled	air-to-air aftercooled
	Swept volume	4	4
	Speed governing	4.5 l	4.5 l
	Capacity of oil sump - initial fill	electronic	electronic
	Capacity of cooling system	14.7 l	14.7 l
	Electrical system	20.5 l	20.5 l
	Emission compliance	12 Vdc	12 Vdc
	Maximum permissible load factor of PRP during 24h period	EU stage IIIA	EU stage IIIA
		70%	70%
<i>Alternator 4)</i>	Standard	IEC34-1	IEC34-1
	Make	ISO 8528-3	ISO 8528-3
	Model	Mecc Alte	Mecc Alte
	Rated output, class H temp. rise	ECP34-1S/4	ECP34-1S/4
	rating type acc. ISO 8528-3	85 kVA	201 kVA
	Degree of protection (IP index acc. NF EN 60-529)	125/40°C	125/40°C
	Insulation stator class	IP 21	IP 21
		H	H

*Power circuit*

Insulation rotor class	H	H
Number of wires	12	12
<b>Circuit-breaker</b>		
Number of poles	4	4
Thermal release 50 Hz PRP It (thermal release is higher at 25°C)	160 A (0.8 x In)	160 A (0.8 x In)
Magnetic release Im	3 x In	3 x In
<b>Fault current protection</b>		
Residual current release IDn	0.030-30 A	0.030-30 A
Insulation resistance (optional)	1-200 kOhm	1-200 kOhm
<b>Outlet sockets (optional)</b>		
	domestic (1x) 2p + PE 16 A 230 V	domestic (1x) 2p + PE 16 A 230 V
	domestic (1x) 2p + PE 16 A 230 V	domestic (1x) 2p + PE 16 A 230 V
	CEE form (1x) 3p + N + PE 16 A 400 V	CEE form (1x) 3p + N + PE 16 A 400 V
	CEE form (1x) 3p + N + PE 32 A 400 V	CEE form (1x) 3p + N + PE 32 A 400 V
	CEE form (1x) 3p + N + PE 63 A 400 V	CEE form (1x) 3p + N + PE 63 A 400 V
Dimensions - basic frame (LxWxH)	2900 x1150 x 1709.5 mm	2900 x1150 x 1709.5 mm
Dimensions - optional skid frame (LxWxH)	2980 x1150 x 1682.0 mm	2980 x1150 x 1682.0 mm
Weight wet mass	2015 kg	2015 kg

*Unit*

## Notes

- 1) Reference conditions for engine performance to ISO 3046-1.
- 2) See derating diagram or consult the factory for other conditions.
- 3) At reference conditions unless otherwise stated.
- 4) Rating definition (ISO 8528-1):  
LTP: Limited Time Power is the maximum electrical power which a generating set is capable of delivering (at variable load), in the event of a utility power failure (for up to 500 hours per year of which a maximum of 300 hours is continuous running). No overload is permitted on these ratings. The alternator is peak continuous rated (as defined in ISO 8528-3) at 25°C.  
ESP: Emergency Standby Power is defined as the maximum power available during a variable electrical power sequence, under the stated operating conditions, for which a generating set is capable of delivering in the event of a utility power outage or under test conditions for up to 200h of operation per year, with the maintenance intervals and procedures being carried out as described by the manufacturers. The permissible average power output ( $P_{pp}$ ) over 24h of operation shall not exceed 70% of the ESP unless otherwise agreed by the engine manufacturer.  
PRP: Prime Power is the maximum power available during a variable power sequence, which may be run for an unlimited number of hours per year, between stated maintenance intervals and under the stated ambient conditions. A 10% overload is permitted for 1 hour in 12 hours. The permissible average power output during a 24h period shall not exceed the stated load factor as indicated in the Technical Specifications above.
- 5) Specific mass fuel used: 0.86 kg/l.

Derating factor % - 1500PRP

Height (m)	Temperature (°C)										
	0	5	10	15	20	25	30	35	40	45	50
0	100	100	100	100	100	100	95	95	95	95	90
500	95	95	95	95	95	95	95	95	95	95	90
1000	95	95	95	95	95	95	95	95	95	95	90
1500	95	95	95	95	95	95	95	95	95	90	90
2000	95	95	95	95	95	95	90	90	90	85	85
2500	90	90	90	90	90	90	85	85	85	NA	NA
3000	90	90	90	90	90	90	85	85	85	NA	NA

Derating factor % - 1800PRP

Height (m)	Temperature (°C)										
	0	5	10	15	20	25	30	35	40	45	50
0	100	100	100	100	100	100	95	95	95	95	90
500	95	95	95	95	95	95	95	95	95	95	90
1000	95	95	95	95	95	95	95	95	95	95	90
1500	95	95	95	95	95	95	95	95	95	90	90
2000	95	95	95	95	95	95	90	90	90	85	85
2500	90	90	90	90	90	90	85	85	85	NA	NA
3000	90	90	90	90	90	90	85	85	85	NA	NA

For use of generator set outside these conditions, please contact Atlas Copco.

## 10.3 Technical specifications for QES 105 units

### 10.3.1 Settings of switches

Switch	Function	Activates at
Engine oil pressure	Shut down	1.0 bar
Engine coolant temperature	Shut down	110°C

### 10.3.2 Specifications of the engine/alternator/unit

		QES 105 - 50Hz	QES 105 - 60Hz
<i>Reference conditions 1)</i>	Rated frequency	50 Hz	60 Hz
	Rated speed	1500 rpm	1800 rpm
	Generator service duty	PRP	PRP
	Absolute air inlet pressure	1 bar(a)	1 bar(a)
	Relative air humidity	30%	30%
	Air inlet temperature	25°C	25°C
<i>Limitations 2)</i>	Maximum ambient temperature	50°C	50°C
	Altitude capability	3000 m	3000 m
	Maximum relative air humidity	85%	85%
	Minimum starting temperature unaided	0°C	0°C
	Minimum starting temperature with cold start equipment (optional)	-18°C/-25°C	-18°C/-25°C
<i>Performance data 2) 3) 4) 5)</i>	Rated active power (PRP)	82.8 kW	83.2 kW
	Rated active power (ESP)	90.9 kW	92.2 kW
	Rated apparent power (PRP)	103.5 kVA	104.0 kVA
	Rated apparent power (ESP)	113.6 kVA	115.3 kVA
	Rated voltage line to line	400 V	480 V
	Rated current 3ph	149.4 A	125.1 A
	Performance class (acc.ISO 8528-5:1993)	G3	G3
	Single step load acceptance (PRP)	60%	75%
		49.7 kW	62.1 kW
	Frequency droop	isochronous	isochronous
	Fuel consumption at no load (PRP) (0%)	kg/h	kg/h
	Fuel consumption at 50% load (PRP)	11.84 kg/h	11.84 kg/h
	Fuel consumption at 75% load (PRP)	16.20 kg/h	17.10 kg/h
	Fuel consumption at full load (PRP) (100%)	20.10 kg/h	20.80 kg/h
	Specific fuel consumption (at full load PRP, 100%)	0.243 kg/kWh	0.250 kg/kWh
	Fuel autonomy at full load with standard tank	9.8 h	9.5 h
Fuel autonomy at full load with 24h tank	29.1 h	28.1 h	

	Max. oil consumption at full load	N/A	N/A
	Maximum sound power level (Lw) complies with 2000/14 EC	92 dB(A)	N/A
	Capacity of standard fuel tank	230 l	230 l
	Capacity of 24h fuel tank	680 l	680 l
	Single step load capability (PRP)	82.8 kW 100%	83.2 kW 100%
<i>Application data</i>	Mode of operation	PRP	PRP
	Site	land use	land use
	Operation	single	single
	Start-up and control mode	manual/automatic	manual/automatic
	Start-up time	unspecified	unspecified
	Mobility/Config. acc. to ISO 8528-1:1993 (optional)	transportable/D mobile/E	transportable/D mobile/E
	Mounting	fully resilient	fully resilient
	Climatic exposure	open air	open air
<i>Engine 4)</i>	Standard	ISO 3046 ISO 8528-2	ISO 3046 ISO 8528-2
	Type John Deere	4045HFG82_B	4045HFG82_B
	Rated net output (PRP)	89.8 kW	88.7 kW
	rating type acc. ISO 3046-7	ICXN	ICXN
	Coolant	coolant	coolant
	Combustion system	HPCR	HPCR
	Aspiration	turbocharged	turbocharged
	Charged air cooling system	air-to-air aftercooled	air-to-air aftercooled
	Number of cylinders	4	4
	Swept volume	4.5 l	4.5 l
	Speed governing	electronic	electronic
	Capacity of oil sump - initial fill	14.7 l	14.7 l
	Capacity of cooling system	20.5 l	22.5 l
	Electrical system	12 Vdc	12 Vdc
	Emission compliance	EU stage IIIA	EU stage IIIA
	Maximum permissible load factor of PRP during 24h period	70%	70%
<i>Alternator 4)</i>	Standard	IEC34-1 ISO 8528-3	IEC34-1 ISO 8528-3
	Make	Mecc Alte	Mecc Alte
	Model	ECP34-2S/4	ECP34-2S/4
	Rated output, class H temp. rise	105 kVA	126 kVA
	rating type acc. ISO 8528-3	125/40°C	125/40°C
	Degree of protection (IP index acc. NF EN 60-529)	IP 21	IP 21
	Insulation stator class	H	H



<i>Power circuit</i>	Insulation rotor class	H	H
	Number of wires	12	12
	<b>Circuit-breaker</b>		
	Number of poles	4	4
	Thermal release 50 Hz PRP It (thermal release is higher at 25°C)	200 A (0.7 x In)	200 A (0.7 x In)
	Magnetic release Im	3 x In	3 x In
	<b>Fault current protection</b>		
	Residual current release IDn	0.030-30 A	0.030-30 A
	Insulation resistance (optional)	1-200 kOhm	1-200 kOhm
	<b>Outlet sockets (optional)</b>		
	domestic (1x) 2p + PE 16 A 230 V	domestic (1x) 2p + PE 16 A 230 V	
	domestic (1x) 2p + PE 16 A 230 V	domestic (1x) 2p + PE 16 A 230 V	
	CEE form (1x) 3p + N + PE 16 A 400 V	CEE form (1x) 3p + N + PE 16 A 400 V	
	CEE form (1x) 3p + N + PE 32 A 400 V	CEE form (1x) 3p + N + PE 32 A 400 V	
	CEE form (1x) 3p + N + PE 63 A 400 V	CEE form (1x) 3p + N + PE 63 A 400 V	
<i>Unit</i>	Dimensions - basic frame (LxWxH)	2900 x1150 x 1709.5 mm	2900 x1150 x 1709.5 mm
	Dimensions - optional skid frame (LxWxH)	2980 x1150 x 1682.0 mm	2980 x1150 x 1682.0 mm
	Weight wet mass	2075 kg	2075 kg

## Notes

- 1) Reference conditions for engine performance to ISO 3046-1.
- 2) See derating diagram or consult the factory for other conditions.
- 3) At reference conditions unless otherwise stated.
- 4) Rating definition (ISO 8528-1):

LTP: Limited Time Power is the maximum electrical power which a generating set is capable of delivering (at variable load), in the event of a utility power failure (for up to 500 hours per year of which a maximum of 300 hours is continuous running). No overload is permitted on these ratings. The alternator is peak continuous rated (as defined in ISO 8528-3) at 25°C.

ESP: Emergency Standby Power is defined as the maximum power available during a variable electrical power sequence, under the stated operating conditions, for which a generating set is capable of delivering in the event of a utility power outage or under test conditions for up to 200h of operation per year, with the maintenance intervals and procedures being carried out as described by the manufacturers. The permissible average power output ( $P_{pp}$ ) over 24h of operation shall not exceed 70% of the ESP unless otherwise agreed by the engine manufacturer.

PRP: Prime Power is the maximum power available during a variable power sequence, which may be run for an unlimited number of hours per year, between stated maintenance intervals and under the stated ambient conditions. A 10% overload is permitted for 1 hour in 12 hours. The permissible average power output during a 24h period shall not exceed the stated load factor as indicated in the Technical Specifications above.
- 5) Specific mass fuel used: 0.86 kg/l.

Derating factor % - 1500PRP

Height (m)	Temperature (°C)										
	0	5	10	15	20	25	30	35	40	45	50
0	100	100	100	100	100	100	95	95	95	95	90
500	95	95	95	95	95	95	95	95	95	95	90
1000	95	95	95	95	95	95	95	95	95	95	90
1500	95	95	95	95	95	95	95	95	95	90	90
2000	95	95	95	95	95	95	90	90	90	85	85
2500	90	90	90	90	90	90	85	85	85	NA	NA
3000	90	90	90	90	90	90	85	85	85	NA	NA

Derating factor % - 1800PRP

Height (m)	Temperature (°C)										
	0	5	10	15	20	25	30	35	40	45	50
0	100	100	100	100	100	100	100	100	95	95	95
500	100	100	100	100	100	100	95	95	95	95	95
1000	95	95	95	95	95	95	95	95	95	95	95
1500	95	95	95	95	95	95	95	95	95	95	95
2000	95	95	95	95	95	95	95	95	95	95	95
2500	95	95	95	95	95	95	95	95	95	NA	NA
3000	95	95	95	95	95	95	95	95	90	NA	NA

For use of generator set outside these conditions, please contact Atlas Copco.

## 10.4 Technical specifications for QES 120 units

### 10.4.1 Settings of switches

Switch	Function	Activates at
Engine oil pressure	Shut down	1.0 bar
Engine coolant temperature	Shut down	110°C

### 10.4.2 Specifications of the engine/alternator/unit

		QES 120 - 50Hz	QES 120 - 60Hz
<i>Reference conditions 1)</i>	Rated frequency	50 Hz	60 Hz
	Rated speed	1500 rpm	1800 rpm
	Generator service duty	PRP	PRP
	Absolute air inlet pressure	1 bar(a)	1 bar(a)
	Relative air humidity	30%	30%
	Air inlet temperature	25°C	25°C
<i>Limitations 2)</i>	Maximum ambient temperature	50°C	50°C
	Altitude capability	3000 m	3000 m
	Maximum relative air humidity	85%	85%
	Minimum starting temperature unaided	0°C	0°C
	Minimum starting temperature with cold start equipment (optional)	-18°C/-25°C	-18°C/-25°C
<i>Performance data 2) 3) 4) 5)</i>	Rated active power (PRP)	96.0 kW	96.0 kW
	Rated active power (ESP)	105.6 kW	105.6 kW
	Rated apparent power (PRP)	120.0 kVA	120.0 kVA
	Rated apparent power (ESP)	132.0 kVA	132.0 kVA
	Rated voltage line to line	400 V	480 V
	Rated current 3ph	173.2 A	144.3 A
	Performance class (acc.ISO 8528-5:1993)	G3	G3
	Single step load acceptance (PRP)	50%	65%
		48.0 kW	62.4 kW
	Frequency droop	isochronous	isochronous
	Fuel consumption at no load (PRP) (0%)	5.5 kg/h	4.1 kg/h
	Fuel consumption at 50% load (PRP)	13.8 kg/h	17.9 kg/h
	Fuel consumption at 75% load (PRP)	16.8 kg/h	19.8 kg/h
	Fuel consumption at full load (PRP) (100%)	23.3 kg/h	23.5 kg/h
	Specific fuel consumption (at full load PRP, 100%)	0.243 kg/kWh	0.245 kg/kWh
	Fuel autonomy at full load with standard tank	8.5 h	8.4 h
	Fuel autonomy at full load with 24h tank	25.1 h	24.9 h

	Max. oil consumption at full load	N/A	N/A
	Maximum sound power level (Lw) complies with 2000/14 EC	95 dB(A)	98 dB(A)
	Capacity of standard fuel tank	230 l	230 l
	Capacity of 24h fuel tank	680 l	680 l
	Single step load capability (PRP)	100%	100%
		96 kW	96 kW
<i>Application data</i>	Mode of operation	PRP	PRP
	Site	land use	land use
	Operation	single	single
	Start-up and control mode	manual/automatic	manual/automatic
	Start-up time	unspecified	unspecified
	Mobility/Config. acc. to ISO 8528-1:1993 (optional)	transportable/D	transportable/D
	Mounting	mobile/E	mobile/E
	Climatic exposure	fully resilient	fully resilient
		open air	open air
<i>Engine 4)</i>	Standard	ISO 3046	ISO 3046
	Type John Deere	ISO 8528-2	ISO 8528-2
	Rated net output (PRP)	4045HFG82_C	4045HFG82_C
	rating type acc. ISO 3046-7	104.9 kW	102.8 kW
	Coolant	ICXN	ICXN
	Combustion system	coolant	coolant
	Aspiration	HPCR	HPCR
	Charged air cooling system	turbocharged	turbocharged
	Number of cylinders	air-to-air aftercooled	air-to-air aftercooled
	Swept volume	4	4
	Speed governing	4.5 l	4.5 l
	Capacity of oil sump - initial fill	electronic	electronic
	Capacity of cooling system	14.7 l	14.7 l
	Electrical system	18 l	18 l
	Emission compliance	12 Vdc	12 Vdc
	Maximum permissible load factor of PRP during 24h period	EU stage IIIA	EU stage IIIA
		70%	70%
<i>Alternator 4)</i>	Standard	IEC34-1	IEC34-1
	Make	ISO 8528-3	ISO 8528-3
	Model	Mecc Alte	Mecc Alte
	Rated output, class H temp. rise	ECP34-1L/4	ECP34-1L/4
	rating type acc. ISO 8528-3	135 kVA	162 kVA
	Degree of protection (IP index acc. NF EN 60-529)	125/40°C	125/40°C
	Insulation stator class	IP 21	IP 21
		H	H

*Power circuit*

Insulation rotor class	H	H
Number of wires	12	12
<b>Circuit-breaker</b>		
Number of poles	4	4
Thermal release 50 Hz PRP It (thermal release is higher at 25°C)	200 A (0.8 x In)	200 A (0.8 x In)
Magnetic release Im	3 x In	3 x In
<b>Fault current protection</b>		
Residual current release IDn	0.030-30 A	0.030-30 A
Insulation resistance (optional)	1-200 kOhm	1-200 kOhm
<b>Outlet sockets (optional)</b>		
	domestic (1x) 2p + PE 16 A 230 V	domestic (1x) 2p + PE 16 A 230 V
	domestic (1x) 2p + PE 16 A 230 V	domestic (1x) 2p + PE 16 A 230 V
	CEE form (1x) 3p + N + PE 16 A 400 V	CEE form (1x) 3p + N + PE 16 A 400 V
	CEE form (1x) 3p + N + PE 32 A 400 V	CEE form (1x) 3p + N + PE 32 A 400 V
	CEE form (1x) 3p + N + PE 63 A 400 V	CEE form (1x) 3p + N + PE 63 A 400 V
<i>Unit</i>		
Dimensions - basic frame (LxWxH)	2900 x1150 x 1709.5 mm	2900 x1150 x 1709.5 mm
Dimensions - optional skid frame (LxWxH)	2980 x1150 x 1682.0 mm	2980 x1150 x 1682.0 mm
Weight wet mass	2135 kg	2135 kg

## Notes

- 1) Reference conditions for engine performance to ISO 3046-1.
- 2) See derating diagram or consult the factory for other conditions.
- 3) At reference conditions unless otherwise stated.
- 4) Rating definition (ISO 8528-1):  
LTP: Limited Time Power is the maximum electrical power which a generating set is capable of delivering (at variable load), in the event of a utility power failure (for up to 500 hours per year of which a maximum of 300 hours is continuous running). No overload is permitted on these ratings. The alternator is peak continuous rated (as defined in ISO 8528-3) at 25°C.  
ESP: Emergency Standby Power is defined as the maximum power available during a variable electrical power sequence, under the stated operating conditions, for which a generating set is capable of delivering in the event of a utility power outage or under test conditions for up to 200h of operation per year, with the maintenance intervals and procedures being carried out as described by the manufacturers. The permissible average power output ( $P_{pp}$ ) over 24h of operation shall not exceed 70% of the ESP unless otherwise agreed by the engine manufacturer.  
PRP: Prime Power is the maximum power available during a variable power sequence, which may be run for an unlimited number of hours per year, between stated maintenance intervals and under the stated ambient conditions. A 10% overload is permitted for 1 hour in 12 hours. The permissible average power output during a 24h period shall not exceed the stated load factor as indicated in the Technical Specifications above.
- 5) Specific mass fuel used: 0.86 kg/l.

Derating factor % - 1500PRP

Height (m)	Temperature (°C)										
	0	5	10	15	20	25	30	35	40	45	50
0	100	100	100	100	100	100	100	100	100	95	95
500	100	100	100	100	100	100	100	95	95	95	95
1000	95	95	95	95	95	95	95	95	95	95	95
1500	95	95	95	95	95	95	95	95	95	95	95
2000	95	95	95	95	95	95	95	95	95	95	90
2500	95	95	95	95	95	95	95	95	95	NA	NA
3000	95	95	95	95	95	95	95	95	95	NA	NA

Derating factor % - 1800PRP

Height (m)	Temperature (°C)										
	0	5	10	15	20	25	30	35	40	45	50
0	100	100	100	100	100	100	100	100	100	95	95
500	100	100	100	100	100	100	100	95	95	95	95
1000	95	95	95	95	95	95	95	95	95	95	95
1500	95	95	95	95	95	95	95	95	95	95	95
2000	95	95	95	95	95	95	95	95	95	95	95
2500	95	95	95	95	95	95	95	95	95	NA	NA
3000	95	95	95	95	95	95	95	95	95	NA	NA

For use of generator set outside these conditions, please contact Atlas Copco.



## 10.5 Technical specifications for QES 150 units

### 10.5.1 Settings of switches

Switch	Function	Activates at
Engine oil pressure	Shut down	1.0 bar
Engine coolant temperature	Shut down	110°C

### 10.5.2 Specifications of the engine/alternator/unit

		QES 150 - 50Hz	QES 150 - 60Hz
<i>Reference conditions 1)</i>	Rated frequency	50 Hz	60 Hz
	Rated speed	1500 rpm	1800 rpm
	Generator service duty	PRP	PRP
	Absolute air inlet pressure	1 bar(a)	1 bar(a)
	Relative air humidity	30%	30%
	Air inlet temperature	25°C	25°C
<i>Limitations 2)</i>	Maximum ambient temperature	50°C	50°C
	Altitude capability	3000 m	3000 m
	Maximum relative air humidity	85%	85%
	Minimum starting temperature unaided	0°C	0°C
	Minimum starting temperature with cold start equipment (optional)	-18°C/-25°C	-18°C/-25°C
<i>Performance data 2) 3) 4) 5)</i>	Rated active power (PRP)	120.0 kW	127.9 kW
	Rated active power (ESP)	131.2 kW	141.0 kW
	Rated apparent power (PRP)	150.0 kVA	159.9 kVA
	Rated apparent power (ESP)	164.0 kVA	176.2 kVA
	Rated voltage line to line	400 V	480 V
	Rated current 3ph	216.5 A	192.3 A
	Performance class (acc.ISO 8528-5:1993)	G3	G3
	Single step load acceptance (PRP)	65%	75%
		78 kW	90 kW
	Frequency droop	isochronous	isochronous
	Fuel consumption at no load (PRP) (0%)	3.5 kg/h	4.4 kg/h
	Fuel consumption at 50% load (PRP)	15.6 kg/h	16.8 kg/h
	Fuel consumption at 75% load (PRP)	22.2 kg/h	23.4 kg/h
	Fuel consumption at full load (PRP) (100%)	28.0 kg/h	30.4 kg/h
	Specific fuel consumption (at full load PRP, 100%)	0.233 kg/kWh	0.237 kg/kWh
	Fuel autonomy at full load with standard tank	11.5 h	10.6 h
	Fuel autonomy at full load with 24h tank	29.2 h	26.9 h

	Max. oil consumption at full load	N/A	N/A
	Maximum sound power level (Lw) complies with 2000/14 EC	91 dB(A)	N/A
	Capacity of standard fuel tank	375 l	375 l
	Capacity of 24h fuel tank	950 l	950 l
	Single step load capability (PRP)	100%	100%
		120.0 kW	127.9 kW
<i>Application data</i>	Mode of operation	PRP	PRP
	Site	land use	land use
	Operation	single	single
	Start-up and control mode	manual/automatic	manual/automatic
	Start-up time	unspecified	unspecified
	Mobility/Config. acc. to ISO 8528-1:1993 (optional)	transportable/D	transportable/D
	Mounting	mobile/E	mobile/E
	Climatic exposure	fully resilient	fully resilient
		open air	open air
<i>Engine 4)</i>	Standard	ISO 3046	ISO 3046
	Type John Deere	ISO 8528-2	ISO 8528-2
	Rated net output (PRP)	6068HFU82_A	6068HFU82_A
	rating type acc. ISO 3046-7	133.9 kW	135.7 kW
	Coolant	ICXN	ICXN
	Combustion system	coolant	coolant
	Aspiration	HPCR	HPCR
	Charged air cooling system	turbocharged	turbocharged
	Number of cylinders	air-to-air aftercooled	air-to-air aftercooled
	Swept volume	6	6
	Speed governing	6.8 l	6.8 l
	Capacity of oil sump - initial fill	electronic	electronic
	Capacity of cooling system	19.5 l	19.5 l
	Electrical system	27.2 l	27.2 l
	Emission compliance	12 Vdc	12 Vdc
	Maximum permissible load factor of PRP during 24h period	EU stage IIIA	EU stage IIIA
		70%	70%
<i>Alternator 4)</i>	Standard	IEC34-1	IEC34-1
	Make	ISO 8528-3	ISO 8528-3
	Model	Mecc Alte	Mecc Alte
	Rated output, class H temp. rise	ECP34-2L/4	ECP34-2L/4
	rating type acc. ISO 8528-3	150 kVA	180 kVA
	Degree of protection (IP index acc. NF EN 60-529)	125/40°C	125/40°C
	Insulation stator class	IP 21	IP 21
		H	H

*Power circuit*

Insulation rotor class	H	H
Number of wires	12	12
<b>Circuit-breaker</b>		
Number of poles	4	4
Thermal release 50 Hz PRP It (thermal release is higher at 25°C)	250 A (0.8 x In)	250 A (0.8 x In)
Magnetic release Im	3 x In	3 x In
<b>Fault current protection</b>		
Residual current release IDn	0.030-30 A	0.030-30 A
Insulation resistance (optional)	1-200 kOhm	1-200 kOhm
<b>Outlet sockets (optional)</b>		
	domestic (1x) 2p + PE 16 A 230 V	domestic (1x) 2p + PE 16 A 230 V
	domestic (1x) 2p + PE 16 A 230 V	domestic (1x) 2p + PE 16 A 230 V
	CEE form (1x) 3p + N + PE 16 A 400 V	CEE form (1x) 3p + N + PE 16 A 400 V
	CEE form (1x) 3p + N + PE 32 A 400 V	CEE form (1x) 3p + N + PE 32 A 400 V
	CEE form (1x) 3p + N + PE 63 A 400 V	CEE form (1x) 3p + N + PE 63 A 400 V
Dimensions - basic frame (LxWxH)	3262 x 1170 x 1856.5 mm	3262 x 1170 x 1856.5 mm
Dimensions - basic frame + 24h fuel tank (LxWxH)	3350 x 1170 x 2225.5 mm	3350 x 1170 x 2225.5 mm
Dimensions - optional skid frame (LxWxH)	3350 x 1170 x 1855.5 mm	3350 x 1170 x 1855.5 mm
Dimensions - optional skid frame + 24h fuel tank (LxWxH)	3350 x 1170 x 2225.5 mm	3350 x 1170 x 2225.5 mm
Weight wet mass	2550 kg	2550 kg

*Unit*

## Notes

- 1) Reference conditions for engine performance to ISO 3046-1.
- 2) See derating diagram or consult the factory for other conditions.
- 3) At reference conditions unless otherwise stated.
- 4) Rating definition (ISO 8528-1):

LTP: Limited Time Power is the maximum electrical power which a generating set is capable of delivering (at variable load), in the event of a utility power failure (for up to 500 hours per year of which a maximum of 300 hours is continuous running). No overload is permitted on these ratings. The alternator is peak continuous rated (as defined in ISO 8528-3) at 25°C.

ESP: Emergency Standby Power is defined as the maximum power available during a variable electrical power sequence, under the stated operating conditions, for which a generating set is capable of delivering in the event of a utility power outage or under test conditions for up to 200h of operation per year, with the maintenance intervals and procedures being carried out as described by the manufacturers. The permissible average power output ( $P_{pp}$ ) over 24h of operation shall not exceed 70% of the ESP unless otherwise agreed by the engine manufacturer.

PRP: Prime Power is the maximum power available during a variable power sequence, which may be run for an unlimited number of hours per year, between stated maintenance intervals and under the stated ambient conditions. A 10% overload is permitted for 1 hour in 12 hours. The permissible average power output during a 24h period shall not exceed the stated load factor as indicated in the Technical Specifications above.
- 5) Specific mass fuel used: 0.86 kg/l.

Derating factor % - 1500PRP

Height (m)	Temperature (°C)											
	0	5	10	15	20	25	30	35	40	45	50	
0	100	100	100	100	100	100	100	100	100	100	95	90
500	100	100	100	100	100	100	100	100	100	100	95	90
1000	100	100	100	100	100	100	100	100	100	100	95	90
1500	100	100	100	100	100	100	100	95	95	95	90	85
2000	95	95	95	95	95	95	95	90	90	90	85	80
2500	90	90	90	90	90	90	90	85	85	85	NA	NA
3000	90	90	90	90	90	90	90	85	85	85	NA	NA

Derating factor % - 1800PRP

Height (m)	Temperature (°C)											
	0	5	10	15	20	25	30	35	40	45	50	
0	100	100	100	100	100	100	100	100	100	100	95	95
500	100	100	100	100	100	100	100	100	95	95	95	95
1000	95	95	95	95	95	95	95	95	95	95	95	95
1500	95	95	95	95	95	95	95	95	95	95	95	95
2000	95	95	95	95	95	95	95	95	95	95	95	90
2500	95	95	95	95	95	95	95	95	95	95	NA	NA
3000	95	95	95	95	95	95	95	95	95	95	NA	NA

For use of generator set outside these conditions, please contact Atlas Copco.

## 10.6 Technical specifications for QES 200 units

### 10.6.1 Settings of switches

Switch	Function	Activates at
Engine oil pressure	Shut down	1.0 bar
Engine coolant temperature	Shut down	110°C

### 10.6.2 Specifications of the engine/alternator/unit

		QES 200 - 50Hz	QES 200 - 60Hz
<i>Reference conditions 1)</i>	Rated frequency	50 Hz	60 Hz
	Rated speed	1500 rpm	1800 rpm
	Generator service duty	PRP	PRP
	Absolute air inlet pressure	1 bar(a)	1 bar(a)
	Relative air humidity	30%	30%
	Air inlet temperature	25°C	25°C
<i>Limitations 2)</i>	Maximum ambient temperature	50°C	50°C
	Altitude capability	3000 m	3000 m
	Maximum relative air humidity	85%	85%
	Minimum starting temperature unaided	0°C	0°C
	Minimum starting temperature with cold start equipment (optional)	-18°C/-25°C	-18°C/-25°C
<i>Performance data 2) 3) 4) 5)</i>	Rated active power (PRP)	160.0 kW	167.0 kW
	Rated active power (ESP)	176.0 kW	184.4 kW
	Rated apparent power (PRP)	200.0 kVA	208.7 kVA
	Rated apparent power (ESP)	220.0 kVA	230.5 kVA
	Rated voltage line to line	400 V	480 V
	Rated current 3ph	288.7 A	251.0 A
	Performance class (acc.ISO 8528-5:1993)	G3	G3
	Single step load acceptance (PRP)	50%	60%
		80 kW	95 kW
	Frequency droop	isochronous	isochronous
	Fuel consumption at no load (PRP) (0%)	4.0 kg/h	5.6 kg/h
	Fuel consumption at 50% load (PRP)	21.6 kg/h	23.6 kg/h
	Fuel consumption at 75% load (PRP)	30.7 kg/h	33.1 kg/h
	Fuel consumption at full load (PRP) (100%)	37.9 kg/h	40.0 kg/h
	Specific fuel consumption (at full load PRP, 100%)	0.237 kg/kWh	0.240 kg/kWh
	Fuel autonomy at full load with standard tank	8.5 h	8.1 h
	Fuel autonomy at full load with 24h tank	21.5 h	20.4 h

	Max. oil consumption at full load	N/A	N/A
	Maximum sound power level (Lw) complies with 2000/14 EC	97 dB(A)	101 dB(A)
	Capacity of standard fuel tank	375 l	375 l
	Capacity of 24h fuel tank	950 l	950 l
	Single step load capability (PRP)	95%	100%
		152 kW	167 kW
<i>Application data</i>	Mode of operation	PRP	PRP
	Site	land use	land use
	Operation	single	single
	Start-up and control mode	manual/automatic	manual/automatic
	Start-up time	unspecified	unspecified
	Mobility/Config. acc. to ISO 8528-1:1993 (optional)	transportable/D	transportable/D
	Mounting	mobile/E	mobile/E
	Climatic exposure	fully resilient	fully resilient
		open air	open air
<i>Engine 4)</i>	Standard	ISO 3046	ISO 3046
	Type John Deere	ISO 8528-2	ISO 8528-2
	Rated net output (PRP)	6068HFU82_B	6068HFU82_B
	rating type acc. ISO 3046-7	175.3 kW	178.0 kW
	Coolant	ICXN	ICXN
	Combustion system	coolant	coolant
	Aspiration	HPCR	HPCR
	Charged air cooling system	turbocharged	turbocharged
	Number of cylinders	air-to-air aftercooled	air-to-air aftercooled
	Swept volume	6	6
	Speed governing	6.8 l	6.8 l
	Capacity of oil sump - initial fill	electronic	electronic
	Capacity of cooling system	32 l	32 l
	Electrical system	23 l	23 l
	Emission compliance	12 Vdc	12 Vdc
	Maximum permissible load factor of PRP during 24h period	EU stage IIIA	EU stage IIIA
		70%	70%
<i>Alternator 4)</i>	Standard	IEC34-1	IEC34-1
	Make	ISO 8528-3	ISO 8528-3
	Model	Mecc Alte	Mecc Alte
	Rated output, class H temp. rise	ECO38-2S/4	ECO38-2S/4
	rating type acc. ISO 8528-3	200 kVA	240 kVA
	Degree of protection (IP index acc. NF EN 60-529)	125/40°C	125/40°C
	Insulation stator class	IP 21	IP 21
		H	H

*Power circuit*

Insulation rotor class	H	H
Number of wires	12	12
<b>Circuit-breaker</b>		
Number of poles	4	4
Thermal release 50 Hz PRP It (thermal release is higher at 25°C)	400 A (0.7 x In)	400 A (0.7 x In)
Magnetic release Im	3 x In	3 x In
<b>Fault current protection</b>		
Residual current release IDn	0.030-30 A	0.030-30 A
Insulation resistance (optional)	1-200 kOhm	1-200 kOhm
<b>Outlet sockets (optional)</b>		
	domestic (1x) 2p + PE 16 A 230 V	domestic (1x) 2p + PE 16 A 230 V
	domestic (1x) 2p + PE 16 A 230 V	domestic (1x) 2p + PE 16 A 230 V
	CEE form (1x) 3p + N + PE 16 A 400 V	CEE form (1x) 3p + N + PE 16 A 400 V
	CEE form (1x) 3p + N + PE 32 A 400 V	CEE form (1x) 3p + N + PE 32 A 400 V
	CEE form (1x) 3p + N + PE 63 A 400 V	CEE form (1x) 3p + N + PE 63 A 400 V
Dimensions - basic frame (LxWxH)	3262 x 1170 x 1856.5 mm	3262 x 1170 x 1856.5 mm
Dimensions - basic frame + 24h fuel tank (LxWxH)	3350 x 1170 x 2225.5 mm	3350 x 1170 x 2225.5 mm
Dimensions - optional skid frame (LxWxH)	3350 x 1170 x 1855.5 mm	3350 x 1170 x 1855.5 mm
Dimensions - optional skid frame + 24h fuel tank (LxWxH)	3350 x 1170 x 2225.5 mm	3350 x 1170 x 2225.5 mm
Weight wet mass	2660 kg	2660 kg

*Unit*



## Notes

- 1) Reference conditions for engine performance to ISO 3046-1.
- 2) See derating diagram or consult the factory for other conditions.
- 3) At reference conditions unless otherwise stated.
- 4) Rating definition (ISO 8528-1):

LTP: Limited Time Power is the maximum electrical power which a generating set is capable of delivering (at variable load), in the event of a utility power failure (for up to 500 hours per year of which a maximum of 300 hours is continuous running). No overload is permitted on these ratings. The alternator is peak continuous rated (as defined in ISO 8528-3) at 25°C.

ESP: Emergency Standby Power is defined as the maximum power available during a variable electrical power sequence, under the stated operating conditions, for which a generating set is capable of delivering in the event of a utility power outage or under test conditions for up to 200h of operation per year, with the maintenance intervals and procedures being carried out as described by the manufacturers. The permissible average power output ( $P_{pp}$ ) over 24h of operation shall not exceed 70% of the ESP unless otherwise agreed by the engine manufacturer.

PRP: Prime Power is the maximum power available during a variable power sequence, which may be run for an unlimited number of hours per year, between stated maintenance intervals and under the stated ambient conditions. A 10% overload is permitted for 1 hour in 12 hours. The permissible average power output during a 24h period shall not exceed the stated load factor as indicated in the Technical Specifications above.
- 5) Specific mass fuel used: 0.86 kg/l.

Derating factor % - 1500PRP

Height (m)	Temperature (°C)										
	0	5	10	15	20	25	30	35	40	45	50
0	100	100	100	100	100	100	100	100	100	95	90
500	100	100	100	100	100	100	100	100	100	95	90
1000	100	100	100	100	100	100	100	100	95	95	90
1500	100	100	100	100	100	100	95	95	95	90	85
2000	95	95	95	95	95	95	90	90	90	85	80
2500	90	90	90	90	90	90	85	85	85	NA	NA
3000	90	90	90	90	90	90	85	85	85	NA	NA

Derating factor % - 1800PRP

Height (m)	Temperature (°C)										
	0	5	10	15	20	25	30	35	40	45	50
0	100	100	100	100	100	100	100	95	95	95	95
500	95	95	95	95	95	95	95	95	95	95	95
1000	95	95	95	95	95	95	95	95	95	95	95
1500	95	95	95	95	95	95	95	95	95	95	95
2000	95	95	95	95	95	95	95	95	95	95	90
2500	95	95	95	95	95	95	95	95	90	90	NA
3000	95	95	95	95	95	95	95	90	90	90	NA

For use of generator set outside these conditions, please contact Atlas Copco.

## 10.7 Critical bolt connections - torque values

Applications	Screw/Bolt/Nut		
	Type	Class	Torque (Nm)
Lifting beam - frame	M16	8.8	185 ± 20
Engine - engine feet	M12	8.8	85
Engine feet - vibration damper	M12	8.8	54 ± 10
Engine vibration damper - beam	M8	8.8	25 ± 3
Engine beam - frame	M8	8.8	25 ± 3
Alternator - vibration damper	M12	8.8	54 ± 10
Alternator vibration damper - beam	M8	8.8	25 ± 3
Alternator beam - frame	M8	8.8	25 ± 3
Engine-alternator coupling housing	M10	8.8	48 ± 5
Engine-alternator coupling rotor	DIN 912 3/8"	8.8	40 ± 4
Undercarriage axle - frame	M16	8.8	211

## 10.8 Conversion list of SI units into British units

1 bar	=	14.504 psi
1 g	=	0.035 oz
1 kg	=	2.205 lbs
1 km/h	=	0.621 mile/h
1 kW	=	1.341 hp (UK and US)
1 l	=	0.264 US gal
1 l	=	0.220 imp gal (UK)
1 l	=	0.035 cu.ft
1 m	=	3.281 ft
1 mm	=	0.039 in
1 m <sup>3</sup> /min	=	35.315 cfm
1 mbar	=	0.401 in wc
1 N	=	0.225 lbf
1 Nm	=	0.738 lbf.ft
$t_{°F}$	=	$32 + (1.8 \times t_{°C})$
$t_{°C}$	=	$(t_{°F} - 32)/1.8$

A temperature difference of 1°C = a temperature difference of 1.8°F.

## 10.9 Data plate

GRUPOS ELECTROGENOS EUROPA S.A.		
MASA (Kg)		
GENERATOR SET	ISOXXXX	MODEL
FN		HZ XXX
SN COP	Y	KVA XXX
PN COP	Y	KW XXX
VN	Y	V XXX
IN	Y	A XXX
Cos phi xx		XXXX
S/N ESFXXXX	Manuf. year	XXXX
1636 0029 44	MADE IN XXXX	
GRUPOS ELECTROGENOS EUROPA S.A. Poligono Pinarco II, Parcela 20 50450 Pineda (Zaragoza) SPAIN		

- 1 Name of manufacturer
- 2 Maximum permitted total weight of the vehicle
- 3 Machine type
- 4 Mode of operation
- 5 Model number
- 6 Frequency
- 7 Apparent power - PRP
- 8 Active power - PRP
- 9 Nominal rated voltage
- 10 Nominal rated current
- 11 Generator class
- 12 Manufacturing year
- 13 Winding connections
- 14 Power factor
- 15 Serial number
- 16 EEC mark in accordance with Machine Directive 89/392E
- 17 Address of manufacturer

**Circuit diagrams**

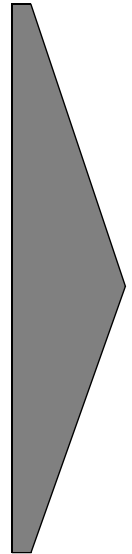

**1636 0107 80/00**  
**Applicable for QES 85-105-120-150-200**

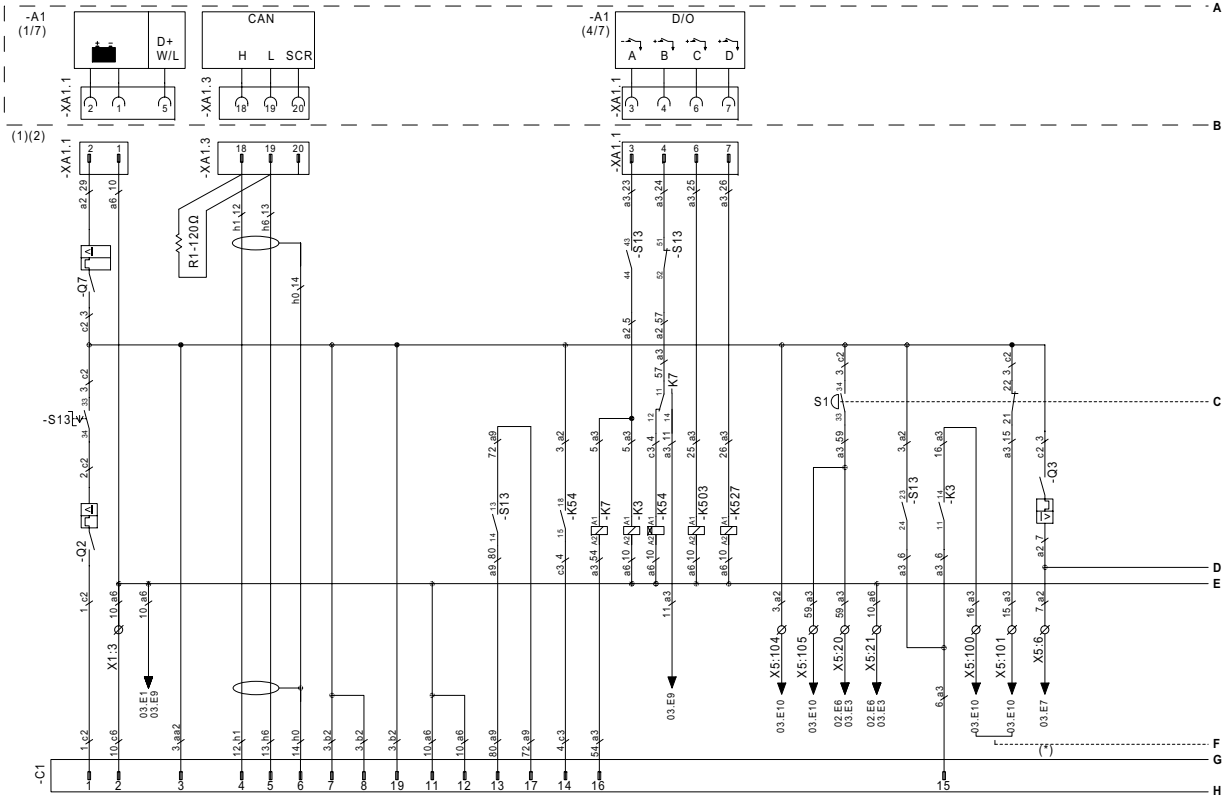

(\*) Terminals X5:102-103 must be bridged if the External Emergency Stop isn't mounted

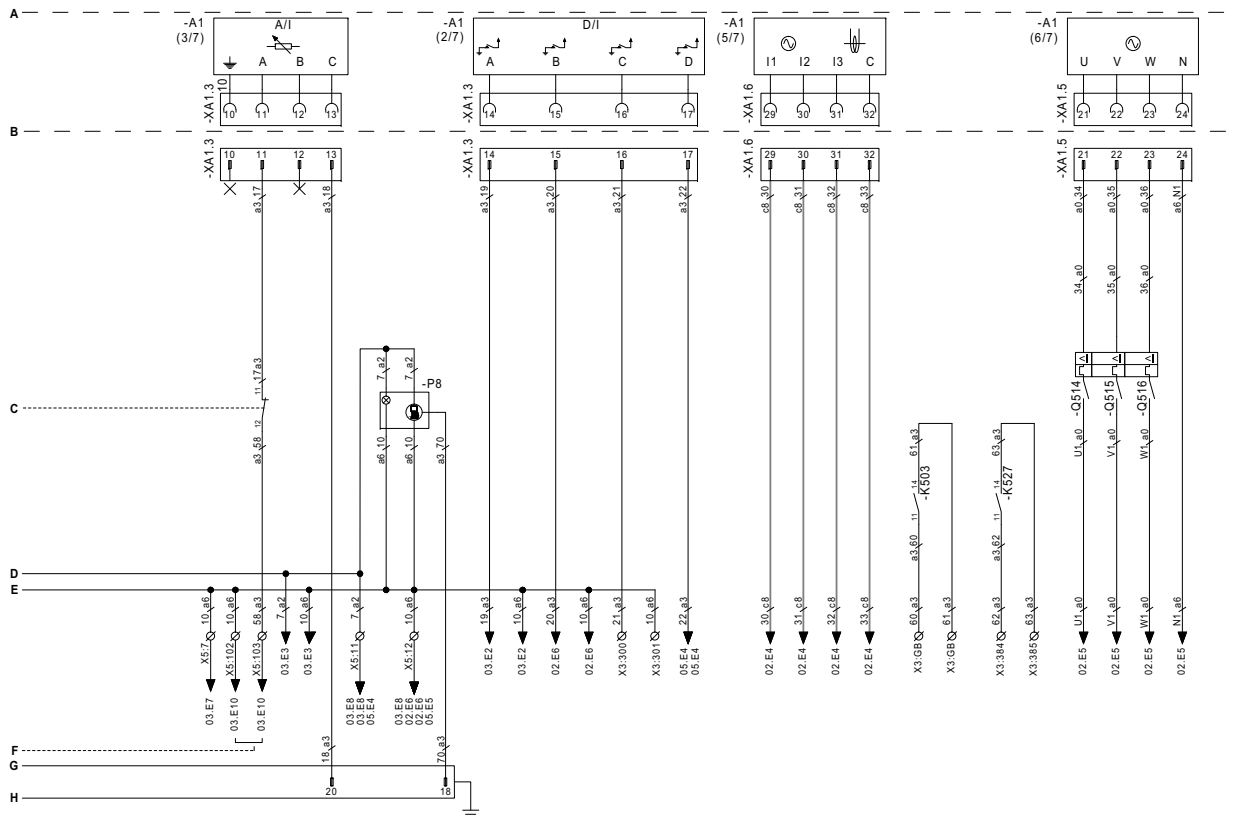

(\*) To remove this connection if IT-Relay is assembled

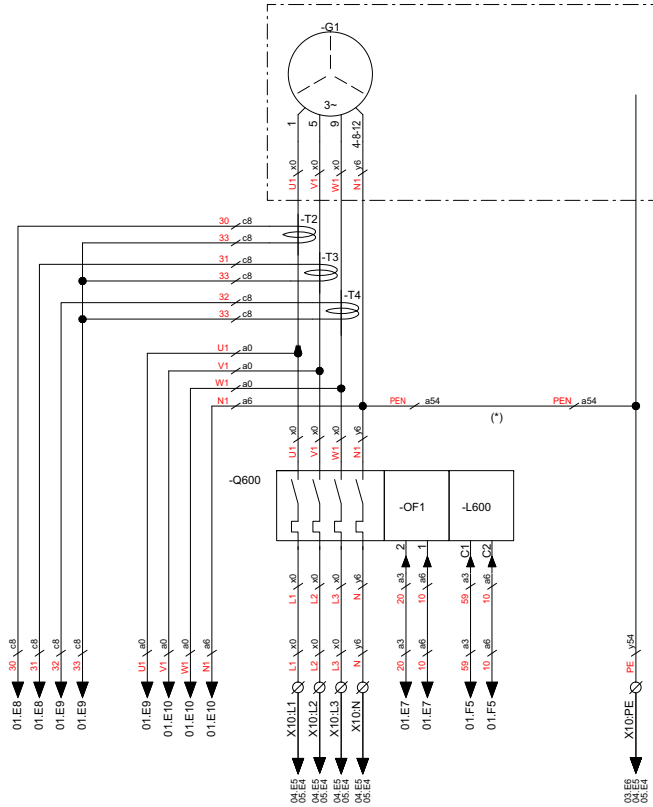



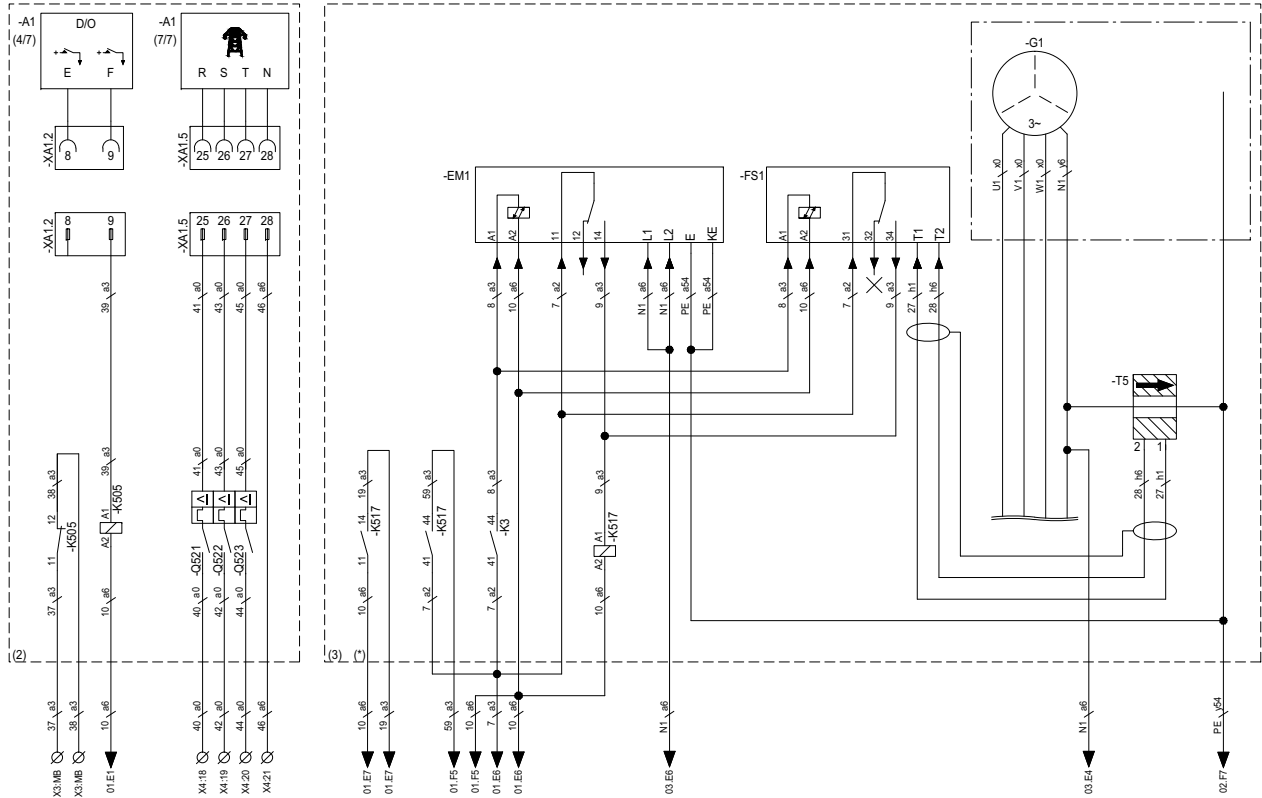

(\*) EL-Relay and IT-Relay can't be together

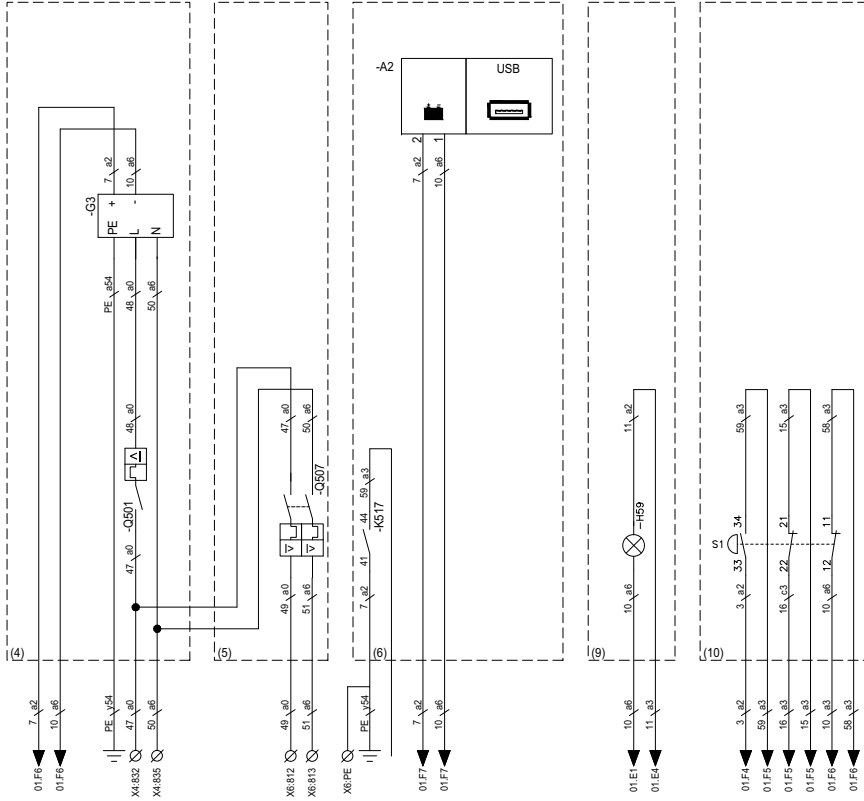

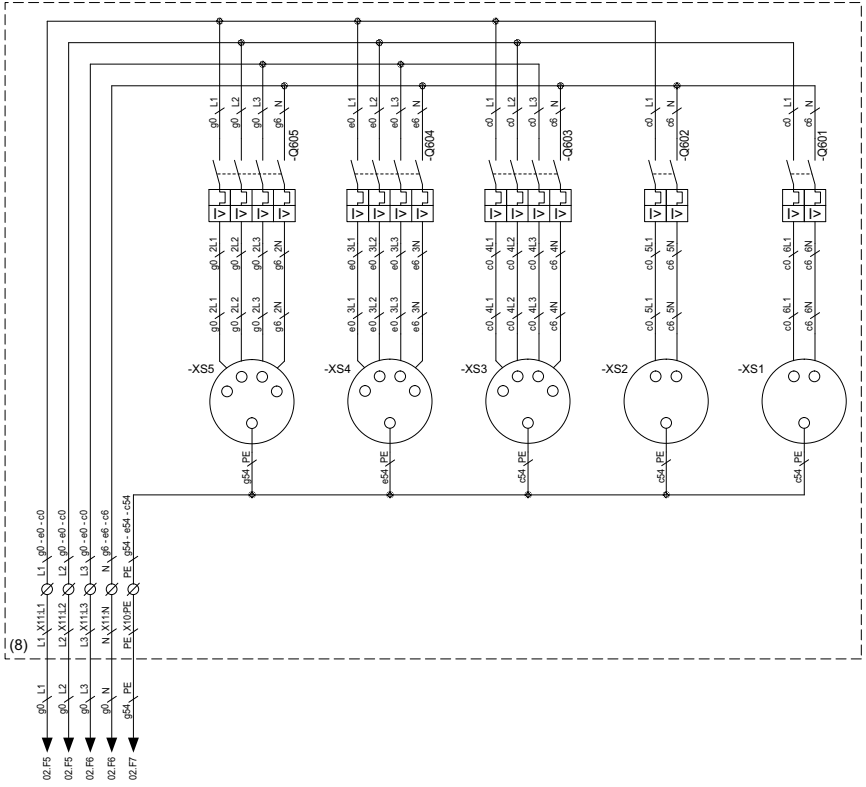
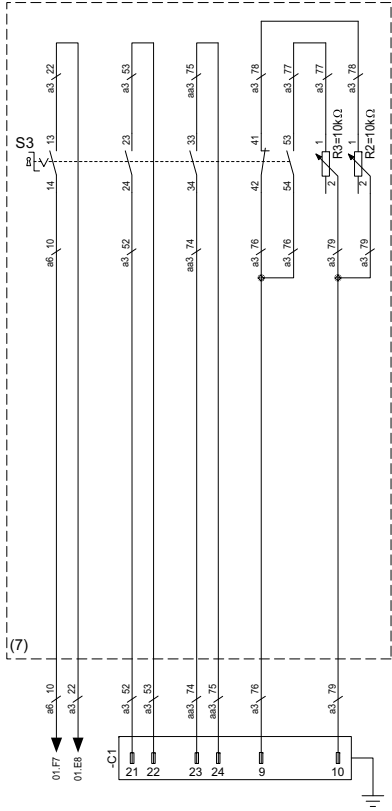

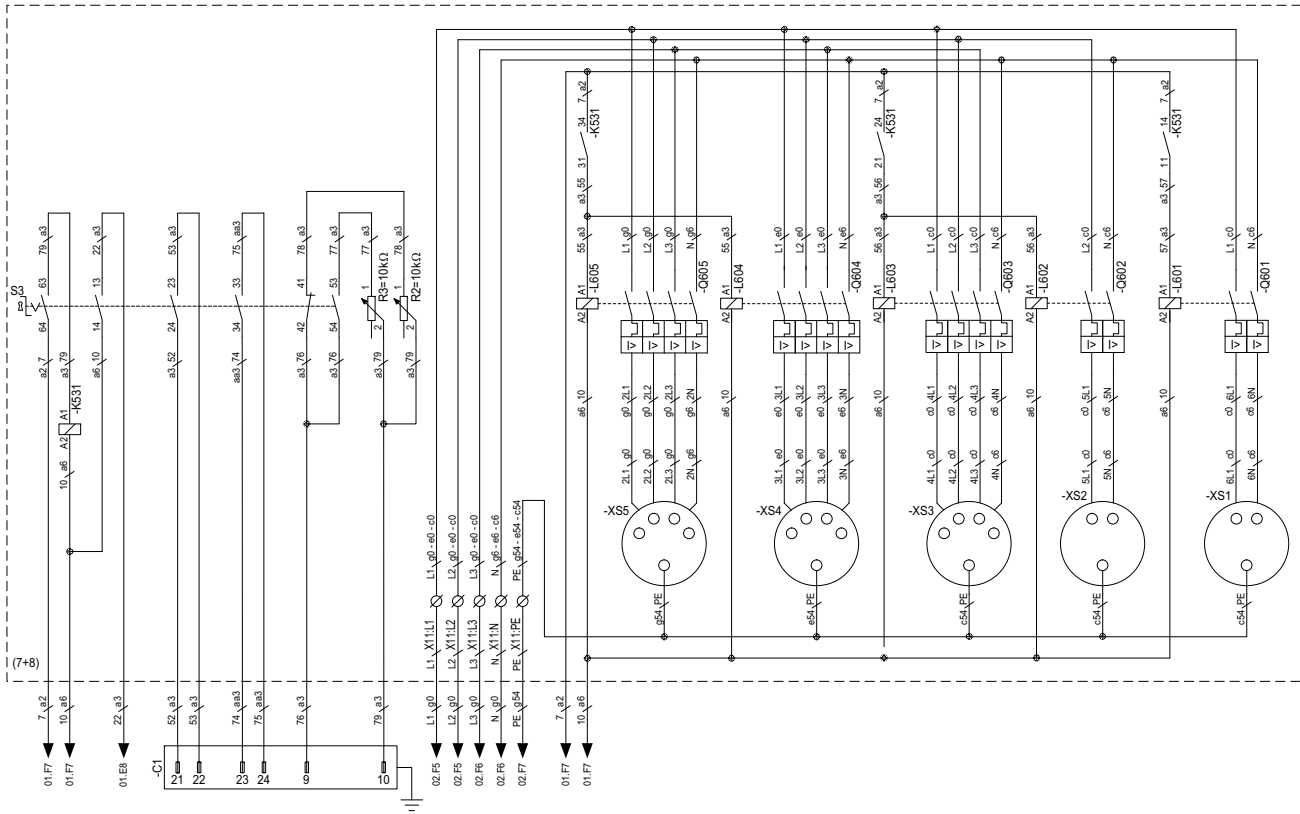

(7+8)



ENGINE

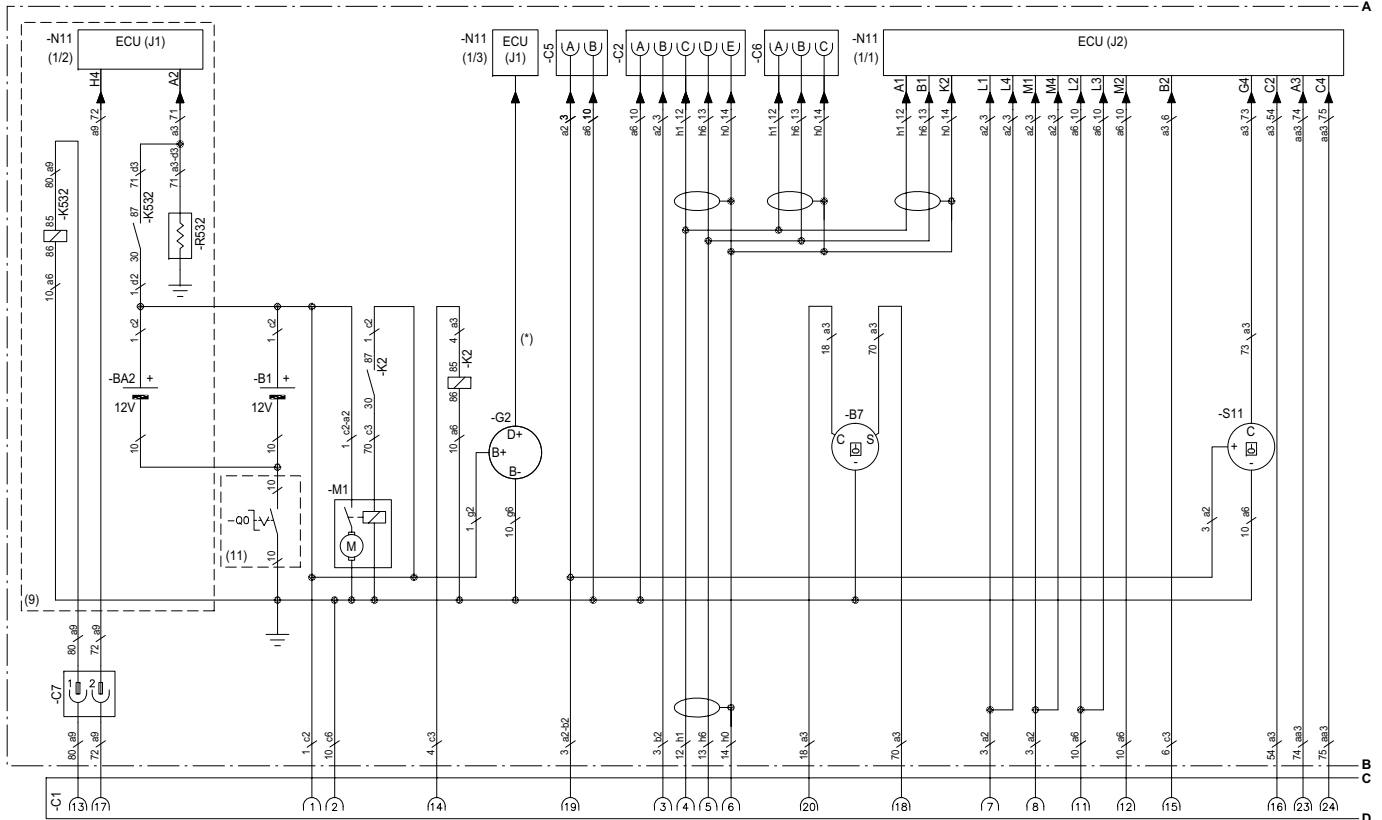

(\*) Engine Manufacturer connection

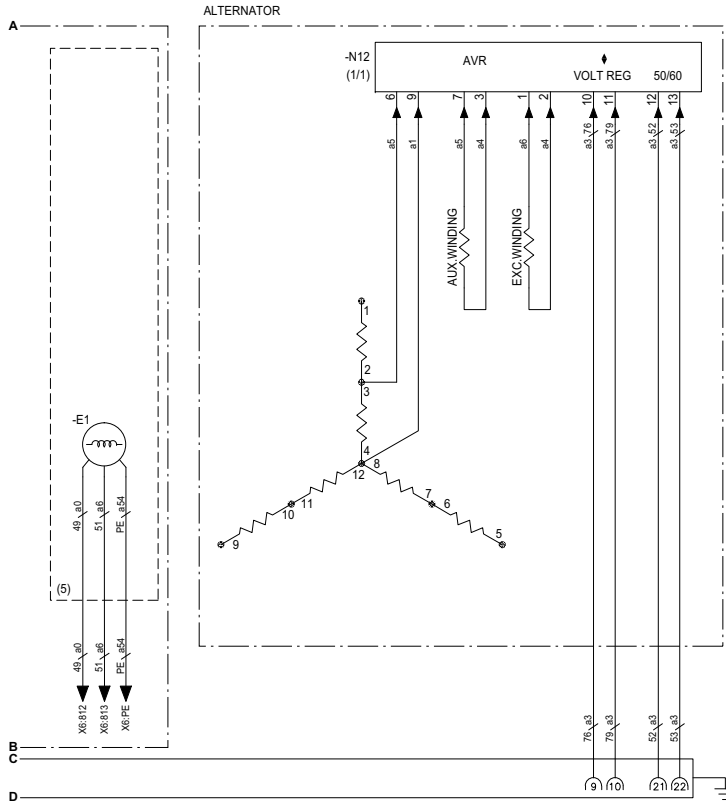

**Legend**

**Wire size :**

- aa = 0.5mm<sup>2</sup>
- a = 1mm<sup>2</sup>
- b = 1.5mm<sup>2</sup>
- c = 2.5mm<sup>2</sup>
- d = 4mm<sup>2</sup>
- e = 6mm<sup>2</sup>
- f = 10mm<sup>2</sup>
- g = 16mm<sup>2</sup>
- h = 2x1mm<sup>2</sup> shielded cable

**Colour code :**

- 0 = BLACK
- 1 = BROWN
- 2 = RED
- 3 = ORANGE
- 4 = YELLOW
- 5 = GREEN
- 6 = BLUE
- 7 = PURPLE
- 8 = GREY
- 9 = WHITE
- 54 = GREEN/YELLOW

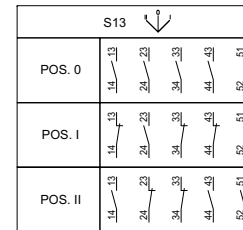
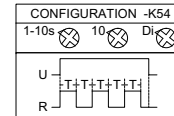

A1	Control module Qc1111/Qc2111 (1)(2)	Q522	Circuit breaker - 1P 2A (2)	Optional
A2	DSE 890 (6)	Q523	Circuit breaker - 1P 2A (2)	Qc1111
B1	Battery	Q600	Circuit breaker - 4P (general)	Qc2111
B2	Battery (9)	Q601	Circuit breaker - 2P 16A (8)	EL-relay or IT-relay
B7	Fuel level sensor	Q602	Circuit breaker - 2P 16A (8)	Battery charger
C1	Industrial connector 24+TT	Q603	Circuit breaker - 4P 16A (8)	Coolant heater
EM1	IT-Relay (3)	Q604	Circuit breaker - 4P 32A (8)	DSE 890
FS1	Earth leakage relay	Q605	Circuit breaker - 4P 63A (8)	Sockets
G2	Charging alternator	R532	Air heater resistor (9)	Cold start
G3	Battery charger (4)	S1	Emergency stop - 1NC/1NO	External emergency stop
K1	Relay 12V 1C - Crank	S2	Emergency stop - 1NC/1NO (10)	Switch off battery
K2	Relay 12V 1C - Crank aux.	S4	Air heater control (9)	
K3	Relay 12V 2C - Fuel relay	S8	Coolant temperature switch	
K503	Relay 12V 1C - Close generator	S9	Oil pressure switch	
K505	Relay 12V 1C - Close mains (2)	S11	Coolant level sensor	
K517	Relay 12V 2C - Earth leakage (3)	S13	ON/OFF switch	
K527	Relay 12V 1C - Common alarm	T2	Electrical current transformer	
K532	Relay 12V 1C - Air heater relay (9)	T3	Electrical current transformer	
K533	Relay 12V 1C - Air heater relay (9)	T4	Electrical current transformer	
L600	Shunt coil 12V	T5	Toroid (3)	
M1	Starter	X1	Control terminals - DC	
M6	Fuel pump	X3	Customer terminals - DC	
N12	AVR	X4	Customer terminals - AC	
P8	Fuel gauge	X5	Options terminals - DC	
Q0	Switch off battery (11)	X6	Options terminals - AC	
Q2	Circuit breaker - 1P 10A	X10	Use terminals - AC	
Q3	Circuit breaker - 1P 6A	X11	Distribution terminals	
Q7	Circuit breaker - 1P 2A	XS1	Socket CEE 16A 2P+T (8)	
Q501	Circuit breaker - 1P 6A (4)	XS2	Socket CEE 16A 2P+T (8)	
Q507	Circuit breaker - 2P 6A (5)	XS3	Socket CEE 16A 3P+N+T (8)	
Q514	Circuit breaker - 1P 2A	XS4	Socket CEE 32A 3P+N+T (8)	
Q515	Circuit breaker - 1P 2A	XS5	Socket CEE 63A 3P+N+T (8)	
Q516	Circuit breaker - 1P 2A			
Q521	Circuit breaker - 1P 2A (2)			



TERMINAL LIST

X1:3	DC	Battery 0V
X3:GB	DC	Close generator output
X3:GB	DC	Close generator output
X3:MB	DC	Close mains output
X3:MB	DC	Close mains output
X3:300	DC	Remote start
X3:301	DC	Remote start
X3:384	DC	Common alarms
X3:385	DC	Common alarms
X4:18	AC	Voltage reference - R
X4:19	AC	Voltage reference - S
X4:20	AC	Voltage reference - T
X4:21	AC	Voltage reference - NR
X4:832	AC	Aux. input AC supply
X4:835	AC	Aux. input AC supply
X5:6	DC	Battery charger +
X5:7	DC	Battery charger -
X5:11	DC	DC power output - 12V
X5:12	DC	DC power output - 0V
X5:20	DC	Shunt coil
X5:21	DC	Shunt coil
X5:100	DC	Emergency stop
X5:101	DC	Emergency stop
X5:102	DC	Emergency stop
X5:103	DC	Emergency stop
X5:104	DC	Emergency stop
X5:105	DC	Emergency stop
X6:812	AC	Heater
X6:813	AC	Heater
X6:PE	AC	PE
X10:L1	AC	Use terminal - L1
X10:L2	AC	Use terminal - L2
X10:L3	AC	Use terminal - L3

X10:N	AC	Use terminal - N
X10:PE	AC	Use terminal - PE
X11:L1	AC	Distribution terminal - L1
X11:L2	AC	Distribution terminal - L2
X11:L3	AC	Distribution terminal - L3
X11:N	AC	Distribution terminal - N
X11:PE	AC	Distribution terminal - PE



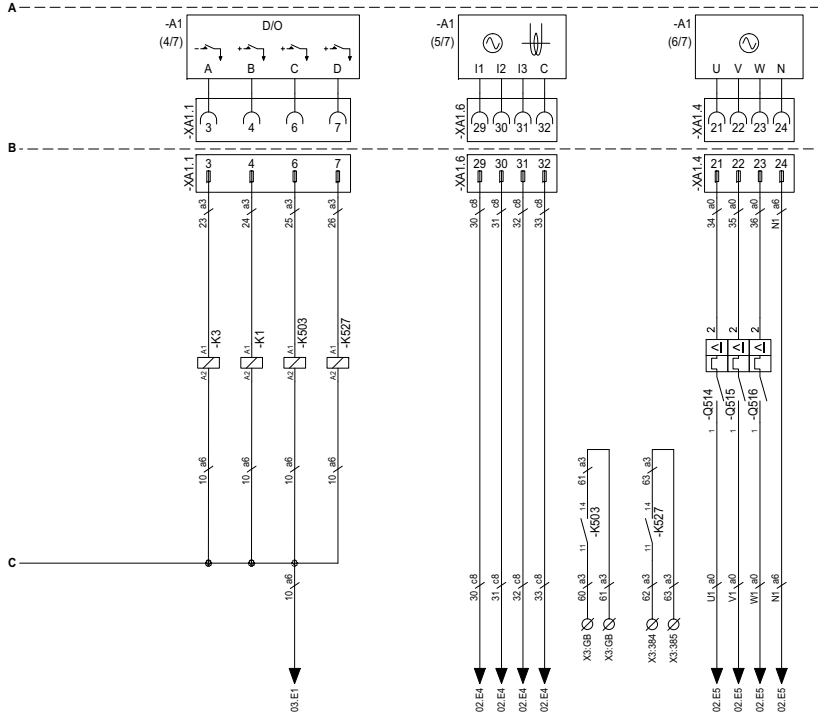

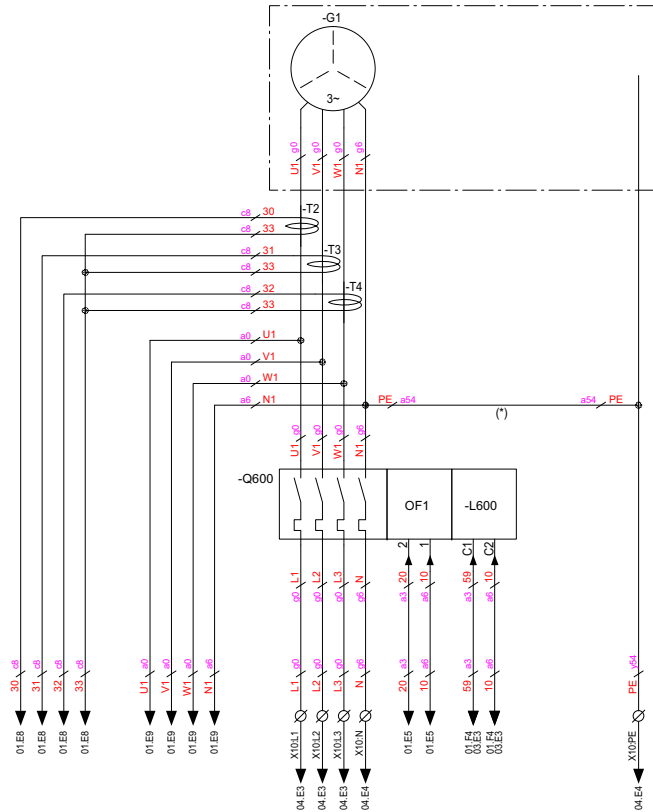

(\*) To remove this connection if IT-Relay is assembled

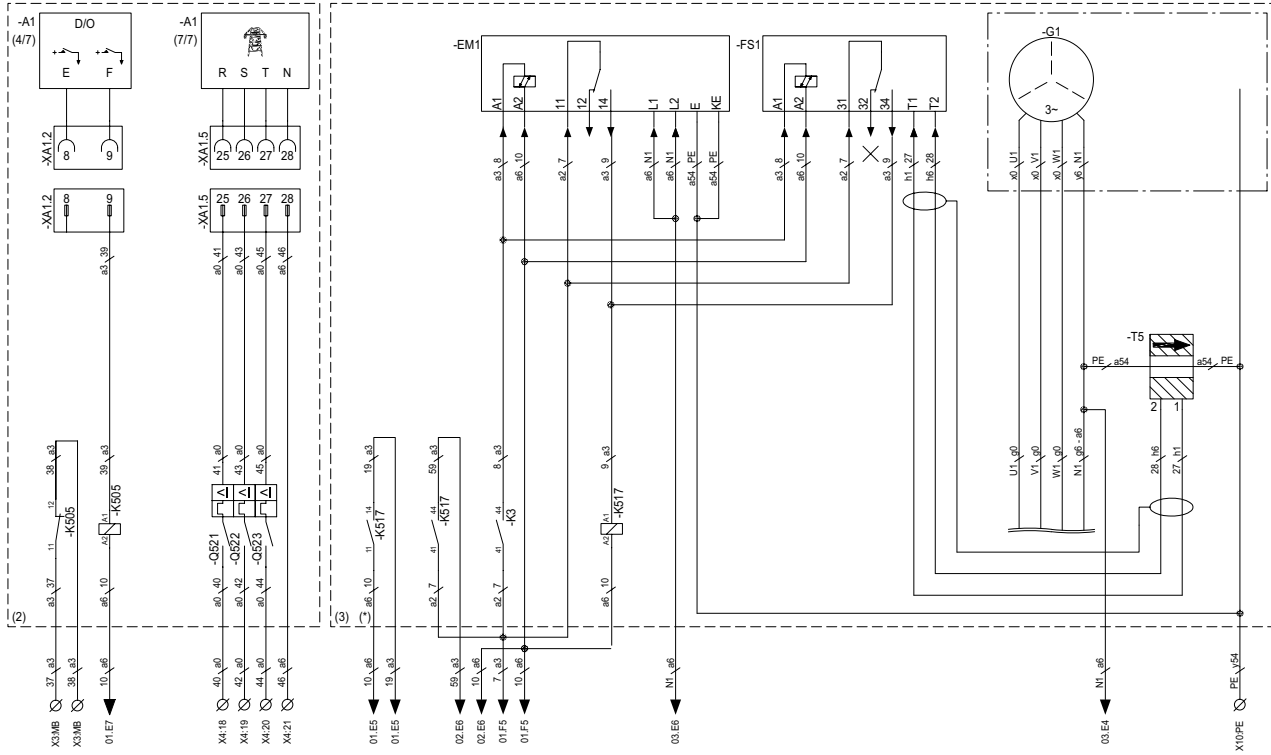

(\* EL-Relay and IT-Relay can't be together



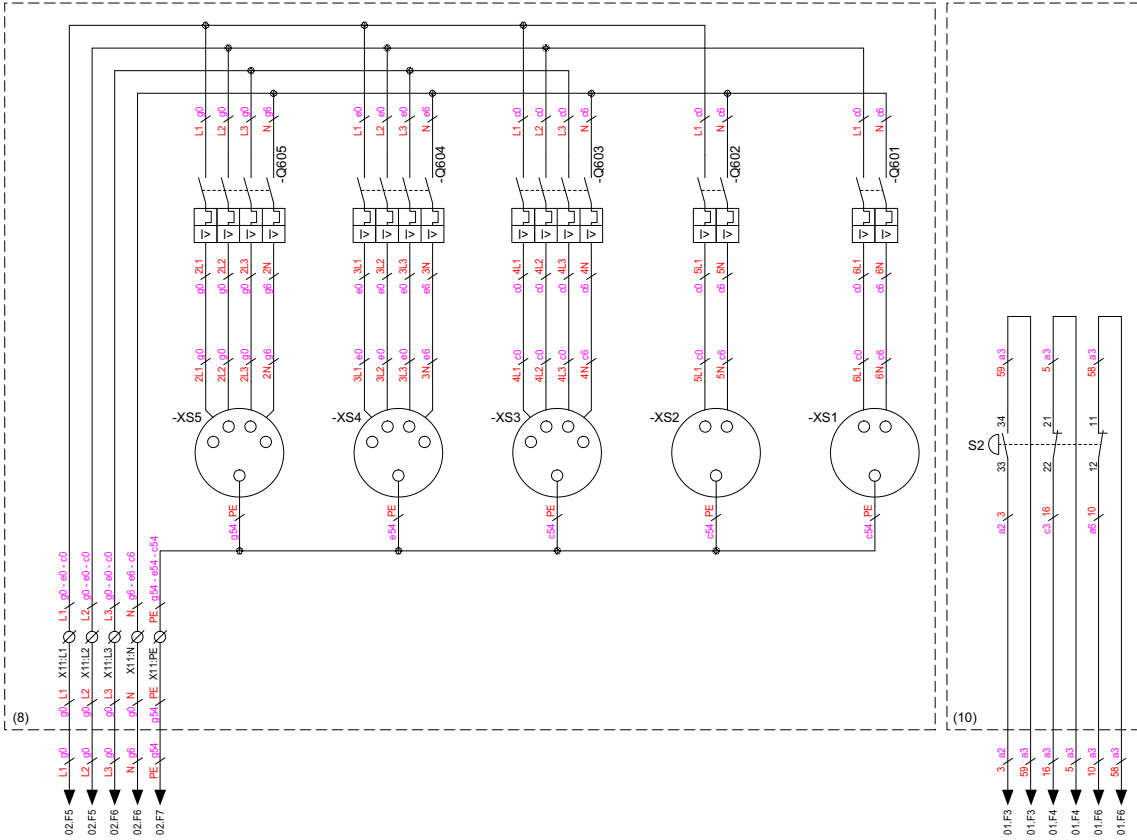





ALTERNATOR

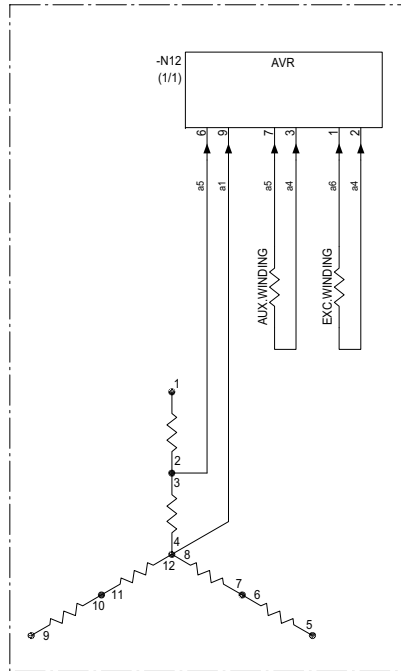

Legend

Wire size :

- aa = 0.5mm<sup>2</sup>
- a = 1mm<sup>2</sup>
- b = 1.5mm<sup>2</sup>
- c = 2.5mm<sup>2</sup>
- d = 4mm<sup>2</sup>
- e = 6mm<sup>2</sup>
- f = 10mm<sup>2</sup>
- g = 16mm<sup>2</sup>
- h = 2x1mm<sup>2</sup> shielded cable

Colour code :

- 0 = BLACK
- 1 = BROWN
- 2 = RED
- 3 = ORANGE
- 4 = YELLOW
- 5 = GREEN
- 6 = BLUE
- 7 = PURPLE
- 8 = GREY
- 9 = WHITE
- 54 = GREEN/YELLOW

A1	Control module Qc1111/Qc2111 (1)(2)	Q3	Circuit breaker - 1P 6A	X10	Use terminals - AC
A2	DSE 890 (6)	Q7	Circuit breaker - 1P 2A	X11	Distribution terminals
B1	Battery	Q501	Circuit breaker - 1P 6A (4)	XS1	Socket CEE 16A 2P+T (7) (7+8)
B2	Battery (9)	Q507	Circuit breaker - 2P 6A (5)	XS2	Socket CEE 16A 2P+T (7) (7+8)
B7	Fuel level sensor	Q514	Circuit breaker - 1P 2A	XS3	Socket CEE 16A 3P+N+T (7) (7+8)
C1	Industrial connector 24+TT	Q515	Circuit breaker - 1P 2A	XS4	Socket CEE 32A 3P+N+T (7) (7+8)
E1	Coolant heater	Q516	Circuit breaker - 1P 2A	XS5	Socket CEE 63A 3P+N+T (7) (7+8)
EM1	IT-Relay (3)	Q521	Circuit breaker - 1P 2A (2)		
FS1	Earth leakage relay	Q522	Circuit breaker - 1P 2A (2)		
G2	Charging alternator	Q523	Circuit breaker - 1P 2A (2)		
G3	Battery charger (4)	Q600	Circuit breaker - 4P (general)	(1)	Optional
H59	Preheat time	Q601	Circuit breaker - 2P 16A (7) (7+8)	(2)	Qc1111
K2	Relay 12V 1C - Crank aux.	Q602	Circuit breaker - 2P 16A (7) (7+8)	(3)	Qc2111
K3	Relay 12V 2C - Fuel relay	Q603	Circuit breaker - 4P 16A (7) (7+8)	(4)	EL-relay or IT-relay
K7	Relay 12V 1C - Preheat	Q604	Circuit breaker - 4P 32A (7) (7+8)	(5)	Battery charger
K54	Relay 12V 1C - Start timer	Q605	Circuit breaker - 4P 63A (7) (7+8)	(6)	Coolant heater
K503	Relay 12V 1C - Close generator	R1	CAN resistor	(7)	DSE 890
K505	Relay 12V 1C - Close mains (2)	R2	Potentiometer - 50 Hz volt reg (7) (7+8)	(8)	50/60 Hz select
K517	Relay 12V 2C - Earth leakage (3)	R3	Potentiometer - 60 Hz volt reg (7) (7+8)	(9)	Sockets
K527	Relay 12V 1C - Common alarm	R532	Air heater resistor (9)	(10)	Cold start
K531	Relay 12V 3C - 50/60 Hz (7)	S1	Emergency stop - 1NC/1NO	(11)	External emergency stop
K532	Relay 12V 1C - Air heater relay (9)	S2	Emergency stop - 1NC/1NO (10)		Switch off battery
L600	Shunt coil 12V	S3	50/60 Hz (7) (7+8)		
L601	Shunt coil 12V (8)	S11	Coolant level sensor		
L602	Shunt coil 12V (8)	S13	ON/OFF switch		
L603	Shunt coil 12V (8)	T2	Electrical current transformer		
L604	Shunt coil 12V (8)	T3	Electrical current transformer		
L605	Shunt coil 12V (8)	T4	Electrical current transformer		
M1	Starter	T5	Toroid (3)		
N11	Engine control unit	X1	Control terminals - DC		
N12	AVR	X3	Customer terminals - DC		
P8	Fuel gauge	X4	Customer terminals - AC		
Q0	Switch off battery (11)	X5	Options terminals - DC		
Q2	Circuit breaker - 1P 10A	X6	Options terminals - AC		

TERMINAL LIST

X1:3	DC	Battery 0V
X3:GB	DC	Close generator output
X3:GB	DC	Close generator output
X3:MB	DC	Close mains output
X3:MB	DC	Close mains output
X3:300	DC	Remote start
X3:301	DC	Remote start
X3:384	DC	Common alarms
X3:385	DC	Common alarms
X4:18	AC	Voltage reference - R
X4:19	AC	Voltage reference - S
X4:20	AC	Voltage reference - T
X4:21	AC	Voltage reference - NR
X4:832	AC	Aux. input AC supply
X4:835	AC	Aux. input AC supply
X5:6	DC	Battery charger +
X5:7	DC	Battery charger -
X5:11	DC	DC power output - 12V
X5:12	DC	DC power output - 0V
X5:20	DC	Shunt coil
X5:21	DC	Shunt coil
X5:100	DC	Emergency stop
X5:101	DC	Emergency stop
X5:102	DC	Emergency stop
X5:103	DC	Emergency stop
X5:104	DC	Emergency stop
X5:105	DC	Emergency stop
X6:812	AC	Heater
X6:813	AC	Heater
X6:PE	AC	PE
X10:L1	AC	Use terminal - L1
X10:L2	AC	Use terminal - L2
X10:L3	AC	Use terminal - L3

X10:N	AC	Use terminal - N
X10:PE	AC	Use terminal - PE
X11:L1	AC	Distribution terminal - L1
X11:L2	AC	Distribution terminal - L2
X11:L3	AC	Distribution terminal - L3
X11:N	AC	Distribution terminal - N
X11:PE	AC	Distribution terminal - PE



Following documents are provided with this unit:

- Test Certificate
- EC Declaration of Conformity:

**EC DECLARATION OF CONFORMITY**

2 We, Grupos Electrogenos Europa S.A., declare under our sole responsibility, that the product  
 3 Machine name : **Power Generator**  
 4 Commercial name :  
 5 Serial number :

6 Which falls under the provisions of the article 12.2 of the EC Directive 2006/42/EC on the approximation of  
 the laws of the Member States relating to machinery, is in conformity with the relevant Essential Health and  
 Safety Requirements of this directive.

The machinery complies also with the requirements of the following directives and their amendments as indicated.

7 Directive on the approximation of laws of the Member States relating to	Harmonized and/or Technical Standards used	Att'mnt
8 Machinery safety	2006/42/EC EN ISO 12100-1 EN ISO 12100-2 UNE EN 12601	
9 Electromagnetic compatibility	2004/108/EC EN 61000-6-2 EN 61000-6-4	
10 Low voltage equipment	2006/95/EC EN 60034 EN 60204-1 EN 60439	
11 Outdoor noise emission	2000/14/EC ISO 3744	

12 The harmonized and the technical standards used are identified in the attachments hereafter  
 13 Grupos Electrogenos Europa, S.A. is authorized to compile the technical file

14	Conformity of the specification to the Directives	Conformity of the product to the specification and by implication to the directives
15	Product Engineering	Manufacturing
16 Issued by		
17 Name		
18 Signature		

19 Place , Date *Muel (Zaragoza), Spain*

---

**Grupos Electrogenos Europa, S.A.** A company within the Atlas Copco Group  
 Postal address: Phone: +34 902 110 316 V.A.T A6032480  
 Polígono Pizarro II, Parcela 20 Fax: +34 902 110 318  
 50450 Muel ZARAGOZA  
 Spain For info, please contact your local Atlas Copco representative  
 www.atlas-copco.com

p. 1/10

– Outdoor Noise Emission  
Directive 2000/14/EC:

---

**Outdoor Noise Emission Directive 2000/14/EC**

---

1. Conformity assessment procedure followed : Full Quality Assurance

2. Name and address of the notified body : Notified body number 0499  
SNCH, Société Nationale de Certification  
et d'Homologation  
L-5201 Sandweiler

3. Measured sound power level :  dB(A)

4. Guaranteed sound power level :  dB(A)

5. Electric power :  kW

---

**Grupos Electrógenos Europa, S.A.** A company within the Atlas Copco Group

Postal address Phone +34 902 110 318 V.A.T A6024680  
Polígono Pizarro II, Parcela 20 Fax +34 902 110 318  
50450 Muel ZARAGOZA  
Spain  
www.atlas-copco.com For info, please contact your local Atlas Copco representative

Form 160003307  
60101201412-00

p.2(10)



