

PROJECTA

INTELLI-CHARGE BATTERY CHARGER

7 STAGE SWITCHMODE



P/No.s IC2500, IC2500W, IC3500, IC5000, IC800-24

IMPORTANT SAFETY INFORMATION

Please read this manual thoroughly before use and store in a safe place for future reference.

WARNING

- Explosive gases may escape from the battery during charging. Prevent flames and sparks. Provide adequate ventilation.
- Before charging, read the instructions.
- For indoor use. Do not expose to rain.
- For charging lead acid batteries ONLY (for the size and voltage specified in the specifications table).
- Disconnect the 240V mains supply before making or breaking the connections to the battery.
- The battery charger must be plugged into an earthed socket-outlet.
- Connection to supply mains is to be in accordance with National wiring rules.
- Do not attempt to charge non-rechargeable batteries.
- Never charge a frozen battery.
- If the AC cord is damaged do not attempt to use. It must be replaced or repaired by a qualified person.
- Corrosive substances may escape from the battery during charging and damage delicate surfaces. Store and charge in a suitable area.
- Ensure all vehicle accessories including lights, heaters, appliances etc are turned off prior to charging.
- This charger is not intended for use by persons (including children) with reduced physical, sensory or mental capabilities, or lack of experience and knowledge, unless they have been given supervision or instruction concerning use of the appliance by a person responsible for their safety.
- Young children should be supervised to ensure that they do not play with the appliance.

7-STAGE AUTOMATIC CHARGING

This is a fully automatic battery charger with 7 charge stages.

Automatic charging protects your battery from being overcharged so you can leave the charger connected to the battery indefinitely.

7-stage charging is a very comprehensive and accurate charging technique that gives your battery longer life and better performance compared to using traditional chargers.

Projecta's Intelli-Charge chargers can be adjusted to suit a number of different battery types including GEL, AGM, WET and Calcium. The chargers can also help restore drained and sulphated batteries.

The 7 charge stages are:

Desulphation; Soft Start; Bulk; Absorption; Analysis; Recondition and Float.

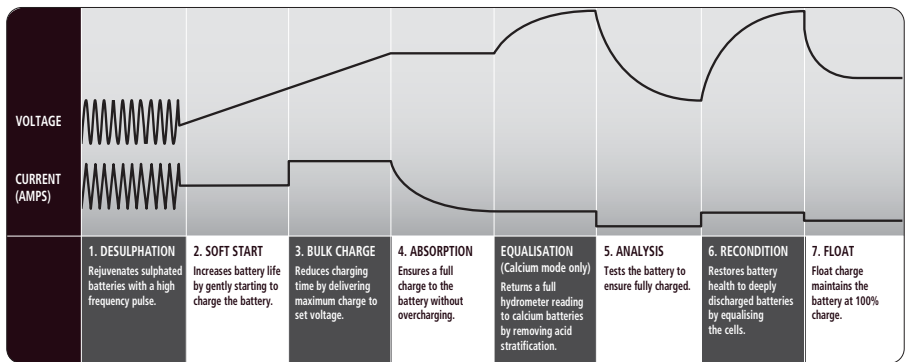

DESULPHATION

The Desulphation stage is designed to break down sulphation occurring in batteries that have been left flat for extended periods of time, returning them back to full charge. Sulphation occurs when lead-sulphate hardens and clogs up the battery cells.

SOFT START

This is a preliminary charge process that gently introduces power to the battery, protecting the battery and increasing battery life.

BULK (CONSTANT CURRENT)

The Bulk stage reduces charging time by charging the battery at the maximum rate (constant current) to a set voltage, at which point the battery is approximately 80% charged.

ABSORPTION (CONSTANT VOLTAGE)

The absorption stage charges the battery to 100% by adjusting the charge rate allowing the battery to absorb more power.

EQUALISATION (CALCIUM MODE ONLY)

Designed especially for calcium batteries, this stage returns calcium batteries to full service by removing acid stratification of the electrolyte.

ANALYSIS

The analysis mode tests the battery to ensure that it has taken the charge; if the battery passes the test the charger will proceed to the float stage, but if the battery fails the test, the charger will apply a recondition charge to try to return the battery to full charge.

RECONDITION

If after charging, the battery is unable to hold the charge the battery reconditioning function is initiated automatically. This is most likely to take place on batteries that have been deeply discharged, prior to charging. The Recondition mode will then run for 4 hours and at the end will retest the battery. The Intelli-Charge battery charger will perform the recondition charge up to 3 times before switching the charging cycle to Float with an error indication.

FLOAT

The Float stage maintains the battery at 100% charge without overcharging or damaging the battery. This means the charger can be left connected to the battery indefinitely.

BATTERY CHEMISTRY SELECTION

The Multi-Chem function allows you to set the charging profile to suit each battery's chemistry type (GEL, AGM, WET and Calcium). This ensures correct and thorough charging and maximises battery performance and battery life. The following section describes the charge profiles for each chemistry type.

POWER SUPPLY (CONSTANT VOLTAGE OF 13.8 VOLTS)

This sets the charger in power supply mode giving a constant voltage of 13.8VDC. This mode is best used where appliances are drawing power from the battery, for example a Fridge.

GEL (MAX VOLTAGE OF 14.1 VOLTS)

This charge mode is designed for GEL batteries and has a maximum charge voltage of 14.1V. Note that some GEL batteries require a higher charge voltage such as 14.4V. The AGM mode can be used if this is required.

AGM (MAX VOLTAGE OF 14.4 VOLTS)

This charge mode is designed for AGM batteries and has a maximum charge voltage of 14.4V.

WET (BULK AND ABSORPTION 14.7 VOLTS, RECONDITION UP TO 16 VOLTS)

This charge mode is designed for WET batteries and has a maximum charge voltage of 14.7V during Bulk and Absorption stages and 16.0V during the Recondition stage.

CALCIUM (BULK AND ABSORPTION 14.7 VOLTS, EQUALISATION AND RECONDITION UP TO 16 VOLTS)

This charge mode is best suited for Calcium batteries that have been deeply discharged and require an equalisation charge to restore a full electrolyte reading. If the battery requires a simple 'top-up', the WET charge mode can be used.

FEATURES

ADJUSTABLE CHARGE RATE

The charger's output can be adjusted to suit the size of the battery for optimum charging.

REMOTE CONTROL DISPLAY*

Control and monitor the charger's performance from a remote control display, allowing the charger to be flush or surface mounted out of the way and out of sight. The battery charger and remote are synchronised for operation either locally or by remote.

RUBBER END CAPS (IC2500W ONLY)

Protective rubber moulded end caps for the toughest workshop conditions.

TEMPERATURE COMPENSATION*

The temperature sensor monitors the battery temperature and adjusts (compensates) the charger's output to prevent overcharging. This is ideal for batteries used in warmer climates or environments.

SWITCHMODE TECHNOLOGY

LCD SCREEN & LED INDICATORS

POLARITY PROTECTION

OVER TEMPERATURE PROTECTION

MOUNTING INSTRUCTIONS

MOUNTING BATTERY CHARGER

Intelli-Charge chargers are designed for indoor, out of weather use only. Ensure that both charger and battery are in a well-ventilated space during charging.

The battery charger end plates include a mounting flange for easy mounting. If permanently fixed the charger should be mounted to a suitable horizontal or vertical panel, with at least 10cm clearance from the end plates to provide adequate ventilation for the cooling fan.

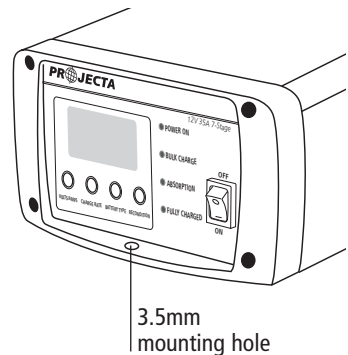

*Not included with IC2500W

MOUNTING REMOTE CONTROL

FLUSH MOUNT

- Cut a 93mm x 70mm hole into the desired mounting surface to suit the supplied mounting plate.
- Position the mounting plate into the hole with the side labelled 'FLUSH MOUNT' facing outwards and screw the supplied screws into the mounting surface as per the below illustration.
- Clip the remote control into the mounting bracket.

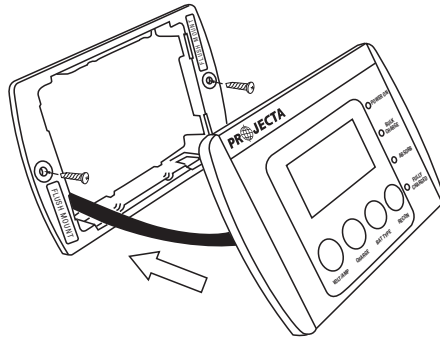

SURFACE MOUNT

- Position the supplied mounting plate onto the desired mounting surface so the side labelled 'SURFACE MOUNT' is facing outwards and screw the supplied screws into the mounting surface as per the below illustration.
- Drill a 15mm cable exit hole into the mounting surface, ensure cable exit hole is positioned directly in the middle of the mounting plate.
- Position the remote control into the remote control surround as per the below illustration and clip into the mounting bracket.

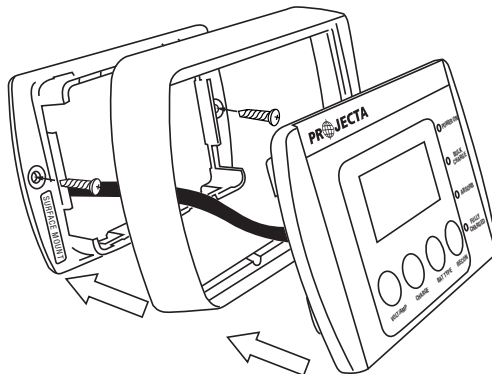

REMOVING REMOTE CONTROL

FLUSH MOUNT

1. Pull the remote control sideways and firmly lift
2. The remote will click out of place

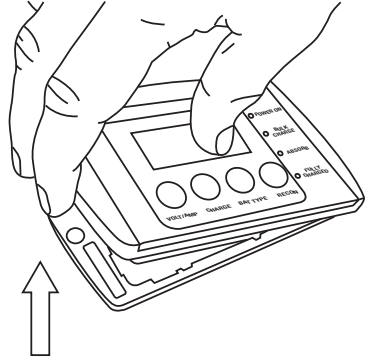
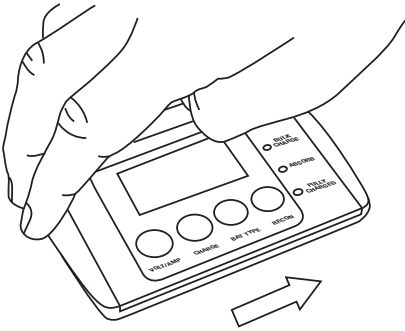

SURFACE MOUNT

1. Holding the remote on either side, push upwards.
2. Squeeze the sides together to lift away.

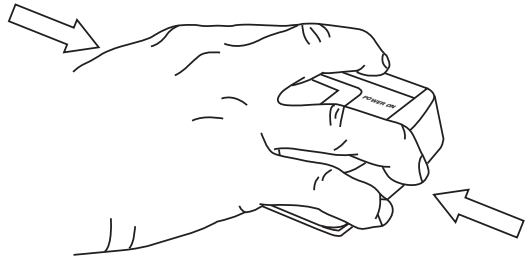
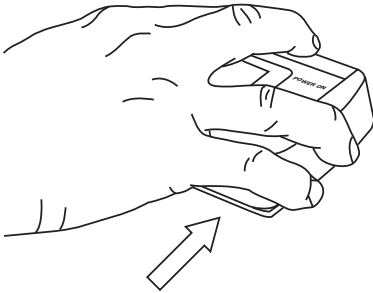

CONTROLS

The battery charger and remote control* interfaces are synchronised and identical in operation allowing you to monitor the battery charger's performance and customise the charge settings to best suit your battery. The function of each button is explained below:

1. **VOLT/AMP:** Change LCD screen display from battery voltage to input current
2. **CHARGE RATE:** Set the charge rate to suit the size of the battery
3. **BATTERY TYPE:** Set the charging profile to suit the battery's chemistry type
4. **RECONDITION:** Initiate recondition mode

*Remote not included with IC2500W



LED CHARGE INDICATORS

BATTERY CHARGER & REMOTE CONTROL*

These battery chargers include coloured LEDs that illuminate various signals to indicate different stages of charging.

LED	LED SIGNAL & STAGES OF CHARGING						
	Desulphation	Soft Start	Bulk	Absorption/ Equalisation	Analysis	Recondition	Float
Bulk Charge (Blue)	Fast Flash - - - - -	Slow Flash - - - -	Solid On _____	-	-	Slow Flash - - - -	-
Absorption (Blue)	-	-	-	Solid On _____	Slow Flash - - - -	Slow Flash - - - -	-
Fully Charged (Green)	-	-	-	-	-	-	Solid On _____
Power On (Red)	Solid On: Normal Flashing: Fault (See Faults & Errors, page 16)						

*Remote not included with IC2500W

CHARGING INSTRUCTIONS

STEP 1 – CHECK THE ELECTROLYTE LEVEL

Prior to charging the battery, remove the vent caps and check the electrolyte level (not required on sealed & maintenance free batteries). The electrolyte should be 6mm (1/4") above the battery's plates. If low, top up with distilled water to the correct level and refit the vent caps.

STEP 2 – CONNECT TO BATTERY

There are three options for connecting to battery.

Step 2A – Connecting to a battery that is out of the vehicle

Step 2B – Connecting to a battery fitted to a vehicle

Step 2C – Permanent hard wiring connection to a battery

STEP 2A – BATTERY OUT OF VEHICLE

Connect the RED lead (battery clip) from the charger to the Positive (+) battery post.

Connect the BLACK lead (battery clip) from the charger to the Negative (-) battery post.

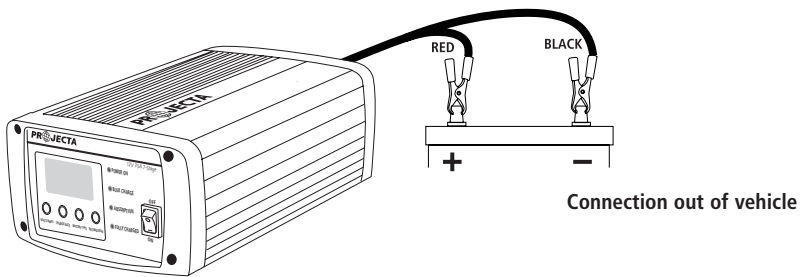

STEP 2B – BATTERY IN VEHICLE

Determine if the vehicle is Positively (+) or Negatively (-) earthed. Negatively earthed vehicles have a cable (usually black) from the Negative battery terminal to the vehicle's chassis.

Negatively earthed (most vehicles)

Connect the RED lead (battery clip) from the charger to the Positive (+) battery terminal.

Connect the BLACK lead (battery clip) from the charger to the vehicle's chassis away from the fuel line or moving parts.

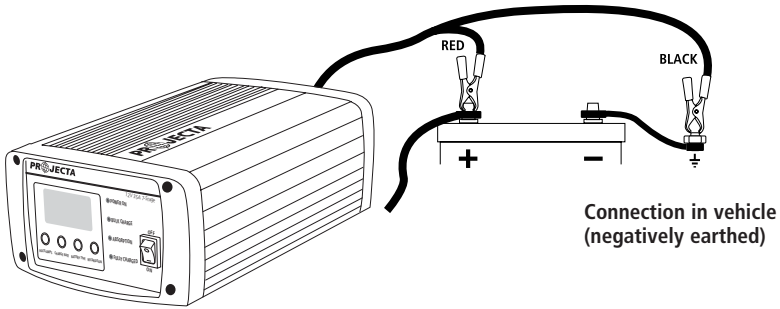

Positively earthed

Connect the BLACK lead (battery clip) from the charger to the Negative (-) battery terminal.

Connect the RED lead (battery clip) from the charger to the vehicle's chassis away from the fuel line or moving parts.

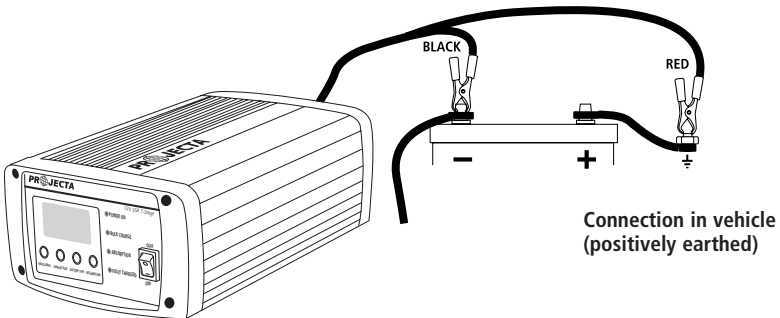

STEP 2C – PERMANENT HARD WIRING

It is possible to hardwire the DC charging leads to the battery for permanent installations.

The DC leads are pre-wired with cable lugs to make this process easier.

It is recommended to fit a circuit breaker or inline fuse with the following ratings. (See below)

IC2500 & IC2500W = 30 Amp

IC3500 = 50 Amp

IC5000 = 100 Amp

IC800-24 = 12 Amp

Connection:

1. Unscrew and remove the battery clips from the DC leads using a 4mm allen key.

Note: These battery chargers include sensor wires that run parallel to both the positive and the negative DC leads. This allows for accurate voltage measurements to be taken directly from the battery. It is strongly recommended not to cut the DC leads during installation. However if the DC leads are cut, ensure that the sensor wires are included in both positive and negative connections.

2. Connect a circuit breaker or inline fuse to the RED Positive (+) lead (include sensor wire if DC lead has been cut).
3. Connect a short cable to the other end of the circuit breaker or inline fuse & connect to the Positive (+) battery post.
4. Connect the cable lug fitted to the BLACK lead to the Negative (-) battery post (include sensor wire if DC lead has been cut).
5. Fit the correctly rated fuse (inline fuse applications only).

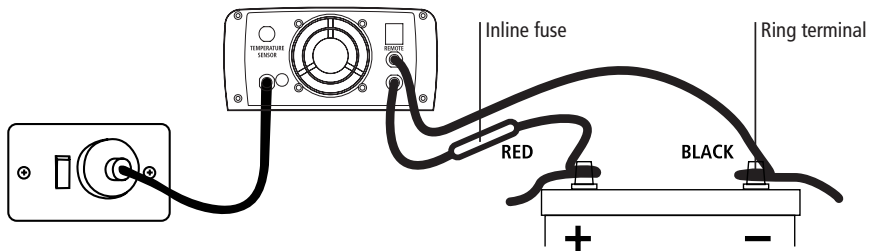

If the charger is used in a Permanent/Hard Wired application and the vehicle will not be used for some time, it is best to leave the charger connected to mains power (turned 'On') so that it can maintain the battery fully charged.

Ensure any modification to the 240V mains lead is carried out by a qualified person and that connection to supply mains is in accordance with National wiring rules.

STEP 3 – REMOTE CONTROL * & TEMPERATURE SENSOR* (OPTIONAL)

If you require the temperature sensor and remote control, install before connecting the charger to 240V mains power. These accessories are optional; the charger will operate normally with or without accessories being fitted.

To install the remote control, insert the data plug into the data socket at the rear of the battery charger.

Cable length: 4.5 metres.

Warning: Ensure the cable is secured safely away from moving parts.

Installing Temperature Sensor

To install the temperature sensor, insert the plug into the temperature sensor socket at the rear of the battery charger. Install the ring terminal to the negative battery terminal.

Cable length: 1.8 metres

Warning: Ensure the cable is secured safely away from moving parts.

STEP 4 – CONNECT TO 240V MAINS POWER

Connect the battery charger to the 240V mains powered socket and turn on the mains power. Turn battery charger On/Off switch to on.

*Not included with IC2500W

STEP 5 – SET CHARGE RATE

The charge rate should be set according to the size of the battery. See the recommended charge rates for various battery sizes in the table below.

(Not all outputs are available on all models)

- Press the CHARGE RATE button. The LCD screen will flash the present setting.
- Press the CHARGE RATE button repeatedly until desired setting is displayed.
- Wait for the LCD screen to stop flashing.

Note: Failure to wait for the screen to stop flashing will cause the charge rate to default to previous setting.

ADJUSTABLE CHARGE RATES: 12 VOLT BATTERIES

CHARGE RATE	BATTERY SIZE (12V)			
	Deep Cycle (AH)	Automotive (CCA)	Marine (MCA)	Time (Hours)
2 Amp	14–40	80–240	110–330	7–24
6 Amp	40–120	240–720	330–1000	7–24
8 Amp	60–160	360–1000	500–1300	7–24
12 Amp	80–240	480–1440	660–2000	7–24
16 Amp	110–320	660–1900	930–2700	7–24
25 Amp	170–500	1000–3000	1400–4200	7–24
35 Amp	240–700	1440–4200	2000–5800	7–24
50 Amp	350–1000	2100–6000	2900–8300	7–24

ADJUSTABLE CHARGE RATES: 24 VOLT BATTERIES

CHARGE RATE	BATTERY SIZE (24V)			
	Deep Cycle (AH)	Automotive (CCA)	Marine (MCA)	Time (Hours)
2 Amp	14–40	80–240	110–330	7–24
4 Amp	30–80	180–480	250–650	7–24
6 Amp	40–120	240–720	330–1000	7–24
8 Amp	60–160	360–1000	500–1300	7–24

STEP 6 – SET BATTERY CHEMISTRY TYPE

Battery Chemistry should be selected by the type of battery being charged (refer to the battery manufacturer’s specifications for battery type). Refer to pages 4 and 5 for a detailed explanation.

For example, if you are charging an AGM battery, then AGM mode will need to be selected. This can be done by the following procedure:

- Press the BATTERY TYPE button. The LCD screen will flash the present setting.
- Press the BATTERY TYPE button repeatedly until desired setting is displayed.
- Wait for the LCD screen to stop flashing.

Note: Failure to wait for the screen to stop flashing will cause the charge rate to default to previous setting.

STEP 7 – CHARGING

During normal charging the LCD screen will default to the VOLTS display; to view input current press the VOLTS/AMPS button.

During Equalisation and Recondition, the LCD screen will display rapid horizontal lines.

STATUS	LCD DISPLAY
Equalisation (Calcium Only) Recondition (Auto) Recondition (Manual)	 Rapid horizontal (scrolling) lines

The LED indicators will also illuminate and flash various signals, indicating the different stages of charging. Refer to page 7 for a description of LED signals.

When the battery is fully charged, the green FULLY CHARGED LED will illuminate. This is known as the float stage and the charger can be left connected to the battery without over charging.

If the red POWER LED is flashing, or the LCD screen displays an error signal, there is a fault; refer to the “Fault & Errors” explanation on page 15 of this manual.

STEP 8 – DISCONNECTION

Ensure the 240V mains switch is turned off and the charger is disconnected from the 240V mains power.

Battery out of vehicle

Remove the BLACK lead (battery clip) from the battery.

Remove the RED lead (battery clip) from battery.

Battery in vehicle

Remove the chassis connection.

Remove the battery terminal connection.

STEP 9 – CHECK THE ELECTROLYTE LEVEL (CALCIUM MODE ONLY)

Check the electrolyte level and top up if required.

INITIATING RECONDITION MODE

The recondition mode can restore batteries from a deeply discharged state by equalising the cells (equalisation charge) ensuring they are operating at full capacity. A recondition charge should be performed periodically to optimise the battery's health and performance.

STEP 1

Follow STEPS 1 to 6 of the "Charging Instructions" of this booklet.

Ensure the battery is removed from the vehicle to prevent the battery's electrolyte from spilling over and damaging the car or engine bay.

STEP 2 – PRESS THE RECONDITION BUTTON

The charger will be in this mode for 4 hours. During recondition the LCD screen will display rapid horizontal lines. Upon completion of the recondition, the charger will proceed to carry out a normal charge on the battery.

STEP 3

Follow STEPS 7 to 9 of the Charging Instructions of this booklet.

LOCKING THE REMOTE CONTROL

Locking the remote control will disable the CHARGE, BAT TYPE & RECON keys from use. This function is ideal for hire vehicles etc as it prevents the chargers settings from being altered if the keys are touched. When locked the VOLT/AMP key will still work to display the volts or amps.

To lock; press and hold the 'CHARGE' and 'BAT TYPE' keys for 3 seconds until you hear a beep. This indicates the keys are now locked.

To unlock; press and hold and 'CHARGE' and 'BAT TYPE' keys for 3 seconds until you hear another beep. This indicates the keys are now unlocked.

FAULTS & ERRORS

There are three error codes that may be displayed. These will be displayed in the following way:

LCD	Power On LED	Fault	Remedy
Err	Slow Flashing	Short circuit or reverse connection of the clips	Check clips are not touching each other OR Check the clips are correctly connected to the battery
F01	Fast Flashing	Bulk charging has timed out and stopped after 22 hours	Battery may be faulty
–	Slow Flashing	The charger has entered recondition mode 3 times and has timed out	Battery may be faulty and may need replacing OR There is a load on the battery causing the battery to fail Analysis
OTP	Fast Flashing	The charger has overheated and has switched off	Ensure adequate ventilation around the charger
OLC	Fast Flashing	Sensor wires are not connected to the positive/negative connections	If DC leads have been cut for hardwiring, check sensor wires are included in both positive & negative connections (Refer to page 13, point 1)
OCP	Fast Flashing	The charger has encountered an error	Contact Brown & Watson International

SPECIFICATIONS

P/No.	IC2500 & IC2500W	IC3500	IC5000	IC800-24
Type	7 stage	7 stage	7 stage	7 stage
Input (nominal)	240VAC, 50Hz	240VAC, 50Hz	240VAC, 50Hz	240VAC, 50Hz
Input Power	792W	1080W	1488W	480W
Output Voltage	12V	12V	12V	24V
Output Current	2, 6, 12, 25A	2, 8, 16, 35A	2, 6, 12, 25, 50A	2, 4, 6, 8A
Minimum Start Voltage	2.5V	2.5V	2.5V	4.5V
Back Drain	1mA	1mA	1mA	1mA
CHARGE CONTROL				
Desulphation Pulse charge up to 11V	High frequency Pulse charge up to 11V	High frequency Pulse charge up to 11V	High frequency Pulse charge up to 22V	High frequency
Soft Start current up to 12V	Half the rated set current up to 12V	Half the rated set current up to 12V	Half the rated set current up to 24V	Half the rated set
Bulk 14.1V (GEL), 14.4V (AGM), 14.7V (WET), 14.7V (CALCIUM)	Set current up to: 14.1V (GEL), 14.4V (AGM), 14.7V (WET), 14.7V (CALCIUM)	Set current up to: 14.1V (GEL), 14.4V (AGM), 14.7V (WET), 14.7V (CALCIUM)	Set current up to: 28.2V (GEL), 28.8V (AGM), 29.4V (WET), 29.4V (CALCIUM)	Set current up to:
Absorption 2 Amp setting: 0.3A 6 Amp setting: 0.9A 12 Amp setting: 1.8A 25 Amp setting: 3.75A	Constant voltage until current drops to the following set points: 2 Amp setting: 0.3A 8 Amp setting: 1.2A 16 Amp setting: 2.4A 35 Amp setting: 5.25A	Constant voltage until current drops to the following set points: 2 Amp setting: 0.3A 6 Amp setting: 0.9A 12 Amp setting: 1.8A 25 Amp setting: 3.75A 50 Amp setting: 7.5A	Constant voltage until current drops to the following set points: 2 Amp setting: 0.3A 4 Amp setting: 0.6A 6 Amp setting: 0.9A 8 Amp setting: 1.2A	Constant voltage until current drops to the following set points: 2 Amp setting: 0.3A 4 Amp setting: 0.6A 6 Amp setting: 0.9A 8 Amp setting: 1.2A
Equalization (Calcium mode only) then hold for 1 hour or 12 hour timeout	Constant current (2.0–3.75A) up to 16V then hold for 1 hour or 12 hour timeout	Constant current (2.0–5.25A) up to 16V then hold for 1 hour or 12 hour timeout	Constant current (2.0–7.5A) up to 16V then hold for 1 hour or 12 hour timeout	Constant current (2.0A) up to 32V
Analysis	Monitors battery for 90 sec			
Recondition (0.3–3.75A) for 4 hours limited to: 14.1V (GEL), 14.4V (AGM), 16.0V (WET), 16.0V (CALCIUM)	Constant current (0.3–5.25A) for 4 hours limited to: 14.1V (GEL), 14.4V (AGM), 16.0V (WET), 16.0V (CALCIUM)	Constant current (0.3–7.5A) for 4 hours limited to: 14.1V (GEL), 14.4V (AGM), 16.0V (WET), 16.0V (CALCIUM)	Constant current (0.3–1.2A) for 4 hours limited to: 28.2V (GEL), 28.8V (AGM), 32.0V (WET), 32.0V (CALCIUM)	Constant current
Float	13.7V	13.7V	13.7V	27.4V
POWER SUPPLY				
Set Voltage	13.8V	13.8	13.8V	27.6V
Maximum Current	25A	35A	50A	8A
BATTERY RANGE				
Deep Cycle	14–500Ah	14–700Ah	14–1000Ah	14–160Ah
Automotive	80–300CCA	80–420CCA	80–600CCA	80–1000CCA
Marine	110–420MCA	110–580MCA	110–830MCA	110–1300MCA
Types of Batteries	Most types of batteries including GEL, AGM, WET CELL and CALCIUM			
Size (mm) IC2500W:	IC2500: 210 x 81 x 168 218 x 86 x 174	250 x 81 x 168	270 x 81 x 168	190 x 81 x 168
Weight IC2500W:	IC2500: 2.0 kg 2.0 kg	2.6 kg	3.0 kg	1.8 kg

PRODUCT OVERVIEW

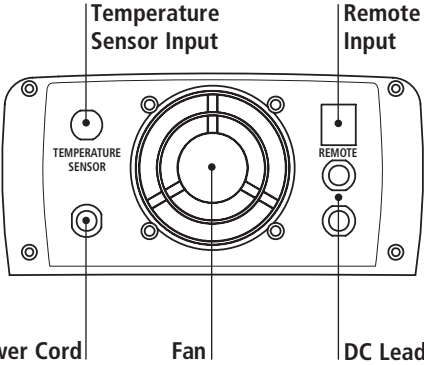
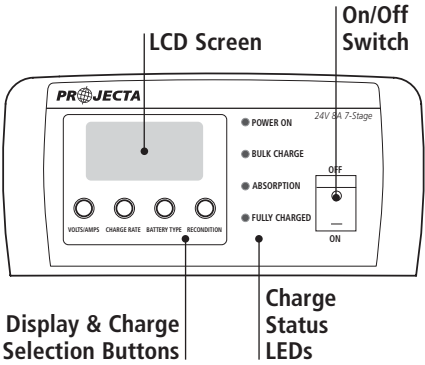

IC800-24

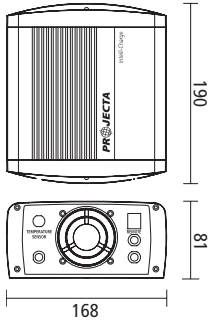

IC2500

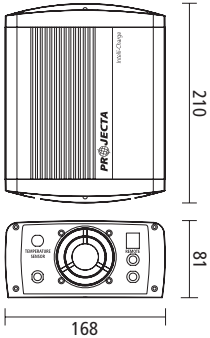

IC2500W

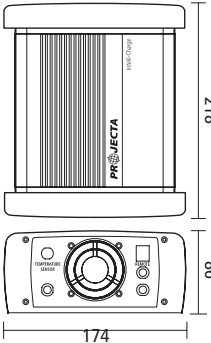

IC3500

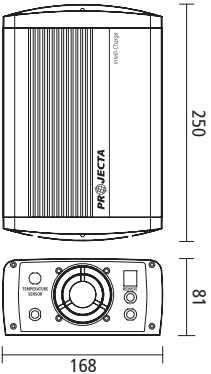

IC5000

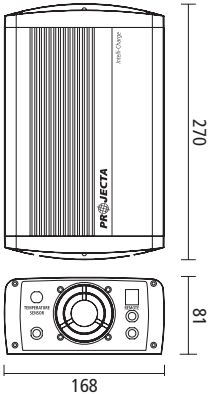

FREQUENTLY ASKED QUESTIONS

Q. How do I know if the battery is charged?

A. The charger's FULLY CHARGED LED will illuminate (solid) and the remote's bi-colour LED will illuminate green (solid). Alternatively use a Battery Hydrometer (Projecta Part No. BH100). A reading of 1.250 or more in each cell indicates a fully charged battery.

Q. I have connected the charger properly but the LCD display reads 0.0 (zero) Volts and does not appear to be charging.

A. In some cases batteries can be flattened to the point where they have very little or no voltage. This can occur if a small amount of power is used for a long time, for example a map reading light is left on for a week or more. Projecta 7 Stage chargers are designed to charge from as little as as little as 2.5 Volts (12V) or 4.5 Volts (24V).

If the voltage is lower than the voltages stated above use a pair of booster cables to connect between two batteries to provide more than 2.5 Volts (12V) or 4.5 Volts (24V) to the battery being charged. The charger can then start to charge the battery and the booster cables can be removed.

Q. Can I use the charger as a power supply

A. Power Supply mode is designed to operate as a float charge to maintain a battery when running a load or appliance from the battery. Power Supply will only operate when connected to a battery.

Q. How can I tell what stage the battery charger is in?

A. The LCD screen and coloured LEDs indicate the various stages of charging. Refer to pages 7 ("LED Charge Indicators") and 13 ("Charging Instructions – Step 7") of this booklet.

Q. What happens if my battery charger is in Desulphation mode or Soft Start mode, but I want to start bulk charging?

A. Desulphation mode is time limited to 6 hours and Soft Start is limited to 1 hour. If you can not wait for the battery charger to move through these stages you can select Power Supply mode to charge the battery. After an hour of charging in Power Supply mode, there should be sufficient charge in the battery to bypass both Desulphation and Soft Start. Select the correct battery chemistry type to continue charging the battery. Whilst in Power Supply mode the charger will output a full current up to 13.8 Volts (12V) or 27.6 Volts (24V).

Q. What if I have an appliance connected to the battery whilst charging?

- A. Powering an appliance while charging your battery will impact on the battery charger's ability to accurately measure the battery's response to the charge being applied. The battery charger has been designed to accommodate this situation although not recommended.

For optimum charging it is recommended to charge without any appliance load on the battery. Power Supply mode is recommended when an appliance is connected to a battery and is drawing power.

Q. Can I select a different battery chemistry for charging my battery?

- A. Yes the battery chemistry selection can be different to your battery type if the charge voltages match the battery manufacture's recommendations.

Q. Why does CALCIUM mode take so long to charge?

- A. To fully charge a Calcium battery, the battery requires an extra charging stage called 'Equalisation'. This consists of a constant current being fed into the battery until 16 Volts (12V) or 32 Volts (24V) is reached. This rejuvenates the battery cells. This charging stage can take up to 12 hours.

Q. Why do I need a special Calcium mode?

- A. Because of the different chemistry used to make a Calcium battery, a different charging algorithm (or technique) is required. Calcium batteries are also affected when deeply discharged or used heavily. They need to be recharged by a Calcium charger to fully recharge the battery and to maximize the battery's life and performance.

Q. What is a Calcium battery?

- A. Calcium batteries are lead acid batteries that have had calcium added to the lead plates, either to one plate (called Calcium Hybrid) or to both plates (called Calcium-Calcium).

The added calcium provides a number of benefits:

- i. Lower internal resistance which provides a small increase in CCA performance.
- ii. The ability to withstand higher engine bay temperatures.
- iii. Low self discharge rate, which increases the shelf life, typically 4 times longer than a Lead-Lead battery.

NOTES:

WARRANTY STATEMENT

Applicable only to product sold in Australia

Brown & Watson International Pty Ltd of 1500 Ferntree Gully Road, Knoxfield, Vic., telephone (03) 9730 6000, fax (03) 9730 6050, warrants that all products described in its current catalogue (save and except for all bulbs and lenses whether made of glass or some other substance) will under normal use and service be free of failures in material and workmanship for a period of one (1) year (unless this period has been extended as indicated elsewhere) from the date of the original purchase by the consumer as marked on the invoice. This warranty does not cover ordinary wear and tear, abuse, alteration of products or damage caused by the consumer.

To make a warranty claim the consumer must deliver the product at their cost to the original place of purchase or to any other place which may be nominated by either BWI or the retailer from where the product was bought in order that a warranty assessment may be performed. The consumer must also deliver the original invoice evidencing the date and place of purchase together with an explanation in writing as to the nature of the claim.

In the event that the claim is determined to be for a minor failure of the product then BWI reserves the right to repair or replace it at its discretion. In the event that a major failure is determined the consumer will be entitled to a replacement or a refund as well as compensation for any other reasonably foreseeable loss or damage.

This warranty is in addition to any other rights or remedies that the consumer may have under State or Federal legislation.

IMPORTANT NOTE

Our goods come with guarantees that cannot be excluded under the Australian Consumer Law. You are entitled to a replacement or refund for a major failure and compensation for any other reasonably foreseeable loss or damage. You are also entitled to have the goods repaired or replaced if the goods fail to be of acceptable quality and the failure does not amount to a major failure.

Distributed by

AUSTRALIA

Brown & Watson International Pty Ltd

Knoxfield, Victoria 3180

Telephone (03) 9730 6000

Facsimile (03) 9730 6050

National Toll Free 1800 113 443

NEW ZEALAND

Narva New Zealand Ltd

22–24 Olive Road

PO Box 12556 Penrose

Auckland, New Zealand

Telephone (09) 525 4575

Facsimile (09) 579 1192