



sigma®



Costruzione macchine 
per piastrellisti

Manufacture of machines 
for tile-layers

Construction de machines 
pour carreleurs

Herstellung von Maschinen 
für Fliesenleger

Mode d'emploi 

Bruksanvisning 

Οδηγίες για τη χρήση 

Gebrauchsanweisung 

Használati utasítás 

Navodila za uporabo 

Istruzioni per l'uso 

Instructions for use 

Instrucciones de uso 

Instrukcje użytkowania 







Instrucțiuni de utilizare 



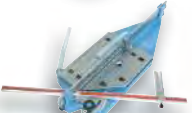
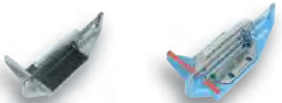

Instruções de utilização 

מכונות לחיתוך קרמיקה "סיגמא" - הוראות שימוש 

инструкции для использования 

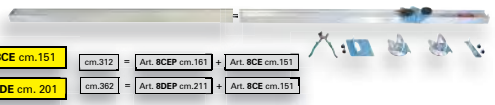
2015

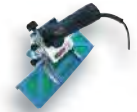
| | | | |
|---|--|---|---------------------------|
| <p>Art. 2G cm.37 Art. 3G cm.45 Art. 3L cm.55 Art. 3B2 cm.65 Art. 3C2 cm.77 Art. 3D2 cm.95</p> |  | <p>Tagliapiastrelle SERIE 3 a trazione Tile cutters SERIE 3 to pull Coupe-carreaux SERIE 3 à tirer Fliesenschnneider SERIE 3 zu ziehen</p> | <p>40 ★★★★</p> |
| <p>Art. 3GM cm.42 Art. 3LM cm.52 Art. 3B2M cm.62 Art. 3C2M cm.74 Art. 3D2M cm.92 Art. 3P2M cm.102 Art. 3E2M cm.128 Art. 3F2M cm.151</p> |  | <p>Tagliapiastrelle SERIE 3 Max Tile cutters SERIE 3 Max Coupe-carreaux SERIE 3 Max Fliesenschnneider SERIE 3 Max</p> | <p>42 ★★★★</p> |
| <p>Art. 3GK cm.42 Art. 3LK cm.52 Art. 3B2K cm.62 Art. 3C2K cm.74 Art. 3D2K cm.92 Art. 3P2K cm.102 Art. 3E2K cm.128</p> |  | <p>Tagliapiastrelle SERIE 3 Klick Klock Tile cutters SERIE 3 Klick Klock Coupe-carreaux SERIE 3 Klick Klock Fliesenschnneider SERIE 3 Klick Klock</p> | <p>46 ★★★★</p> |
| <p>Art. 2A3 cm.51 Art. 2B3 cm.66</p> |  | <p>Tagliapiastrelle TECNICA Tile cutters TECNICA Coupe-carreaux TECNICA Fliesenschnneider TECNICA</p> | <p>50 ★★★</p> |
| <p>Art. 2C4 cm.46 Art. 2D4 cm.61</p> |  | <p>Tagliapiastrelle TECNICA Tile cutters TECNICA Coupe-carreaux TECNICA Fliesenschnneider TECNICA</p> | <p>52 ★★★</p> |
| <p>Art. 5A cm.51 Art. 5B cm.62 Art. 4A cm.75</p> |  | <p>Tagliapiastrelle DIAGONALE Tile cutters DIAGONALE Coupe-carreaux DIAGONALE Fliesenschnneider DIAGONALE</p> | <p>54 ★★★</p> |
| <p>Art. 7A cm.33 Art. 7F cm.37</p> |  | <p>Tagliapiastrelle STANDARD Tile cutters STANDARD Coupe-carreaux STANDARD Fliesenschnneider STANDARD</p> | <p>56 ★★</p> |
| <p>Art. 6 cm.35 Art. 5 cm.50</p> |  | <p>Tagliapiastrelle STANDARD Tile cutters STANDARD Coupe-carreaux STANDARD Fliesenschnneider STANDARD</p> | <p>58 ★★</p> |
|  | <p>Tagliapiastrelle: Istruzioni - garanzia Tile cutters: Instructions - Warranty Coupe-carreaux: Instructions - Garantie Fliesenschnneider: Anleitung - Garantie</p> | <p>60</p> | |

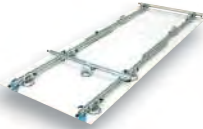
| | | | |
|--|--|--|------------------|
| <p>Art. 8CE cm.151 cm.312 = Art. 8CEP cm.161 + Art. 8CE cm.151 Art. 8DE cm.201 cm.362 = Art. 8DEP cm.211 + Art. 8CE cm.151</p> |  | <p>Tagliapiastrelle KERA-CUT ext Tile cutters KERA-CUT ext Coupe-carreaux KERA-CUT ext Fliesenschnneider KERA-CUT ext</p> | <p>68</p> |
| <p>Art. 8B-2 cm.121 Art. 8C-2 cm.151 Art. 8E-2 cm.301 Art. 8G-2 cm.371</p> |  | <p>Tagliapiastrelle KERA-CUT inx Tile cutters KERA-CUT inx Coupe-carreaux KERA-CUT inx Fliesenschnneider KERA-CUT inx</p> | <p>70</p> |
| <p>Art. 38F3 Art. 38F4</p> |  | <p>Tagliapiastrelle KERA-FLEX Tile cutters KERA-FLEX Coupe-carreaux KERA-FLEX Fliesenschnneider KERA-FLEX</p> | <p>74</p> |
| <p>Art. 36A3 Art. 36B3</p> |  | <p>Smussatrice di precisione Precision chamfers machine Machines pour chanfreins de précision Präzisions Fase maschinen</p> | <p>76</p> |
| <p>Art. 36C3</p> |  | <p>Smussatrice di precisione Precision chamfers machine Machines pour chanfreins de précision Präzisions Fase maschinen</p> | <p>80</p> |
| <p>KERA-LIFT Art.1A max:300 x 150 min:180 x 40 KERA-LIFT Art.1B max:300 x 100 min:180 x 40 KERA-LIFT Art.1C max:100 x 110 min:100 x 30 KERA-LIFT Art.1D max:300 x 100 min:180 x 20</p> |  | <p>Attrezzatura movimentazione KERA-LIFT Apparatus for handling KERA-LIFT Appareil de manipulation KERA-LIFT Vorrichtung zum Handhaben KERA-LIFT</p> | <p>82</p> |

🇮🇹 Tagliapiastrelle

🇫🇷 Coupe Carreaux

🇬🇧 Tile Cutters

🇩🇪 Fliesenschneider

sigma
di Ambrogiani

🇮🇹 » **SERIE 3 MAX** » incisione a spinta , facile e profonda

🇬🇧 » **SERIE 3 MAX** » incision to push, easy and deep

🇫🇷 » **SERIE 3 MAX** » incision à pousser, facile et profonde

🇩🇪 » **SERIE 3 MAX** » Incision zu drücken, einfach und tief



- | | | | |
|-----------------|------------------|------------------|------------------|
| Art. 3GM cm.42 | Art. 3LM cm.52 | Art. 3B2M cm.62 | Art. 3C2M cm.74 |
| Art. 3D2M cm.92 | Art. 3P2M cm.102 | Art. 3E2M cm.128 | Art. 3F2M cm.151 |

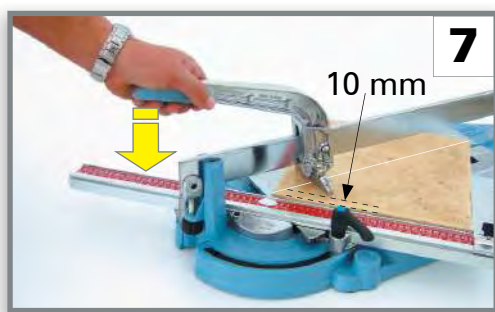
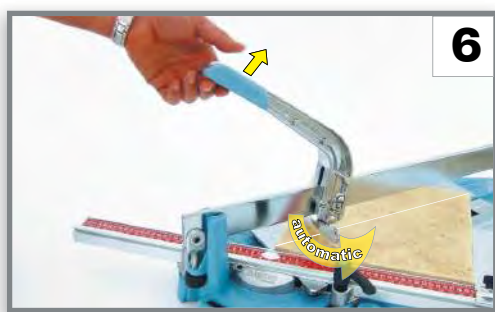
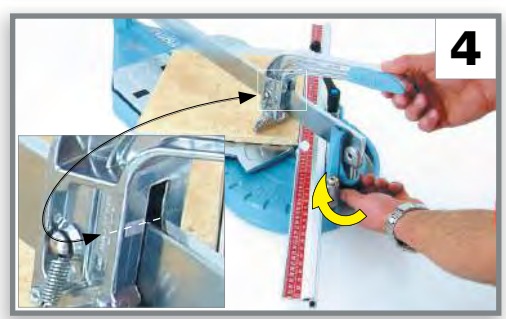
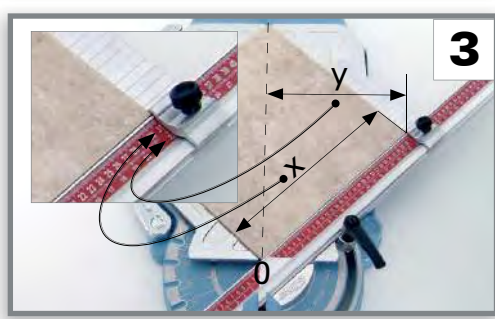
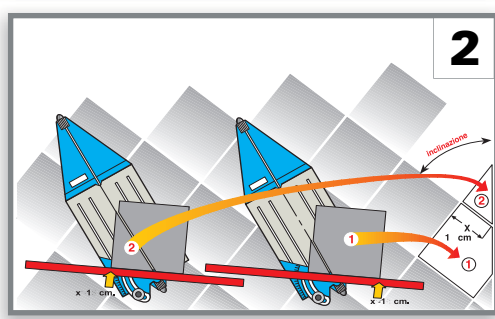
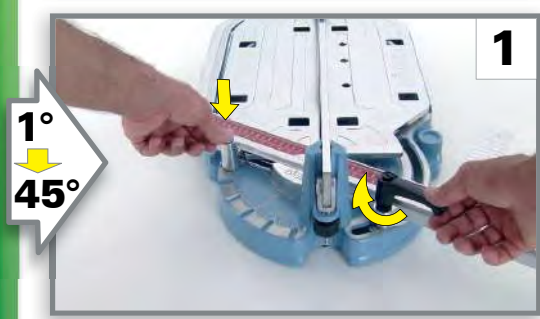
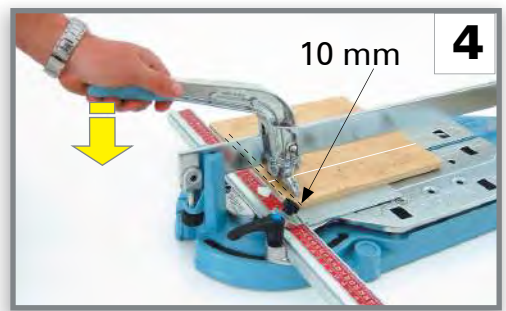
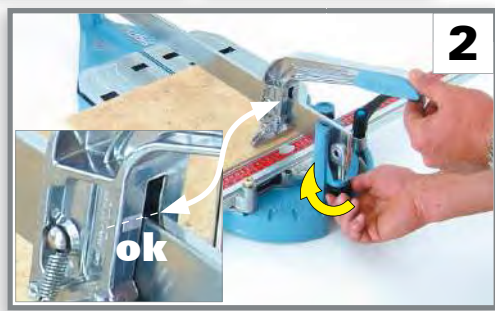
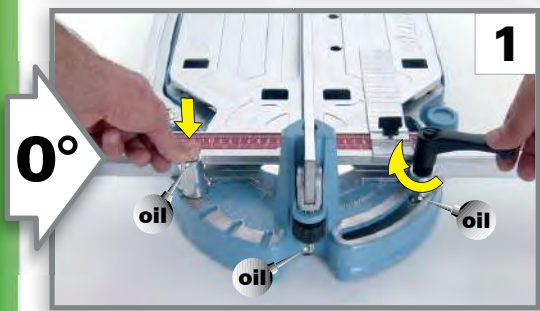

- 🇮🇹 trasporto
- 🇬🇧 transport
- 🇫🇷 le transport
- 🇩🇪 Transport

“ SERIE 3 MAX ” incisione a spinta

“ SERIE 3 MAX ” incision à pousser

sigma
di Ambrogiani

“ SERIE 3 MAX ” incision to push

“ SERIE 3 MAX ” Incision zu drücken

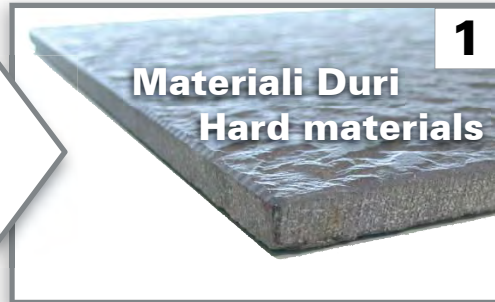

Art. 3E2M cm.128

Art. 3F2M cm.151



www.youtube.com/valterambro

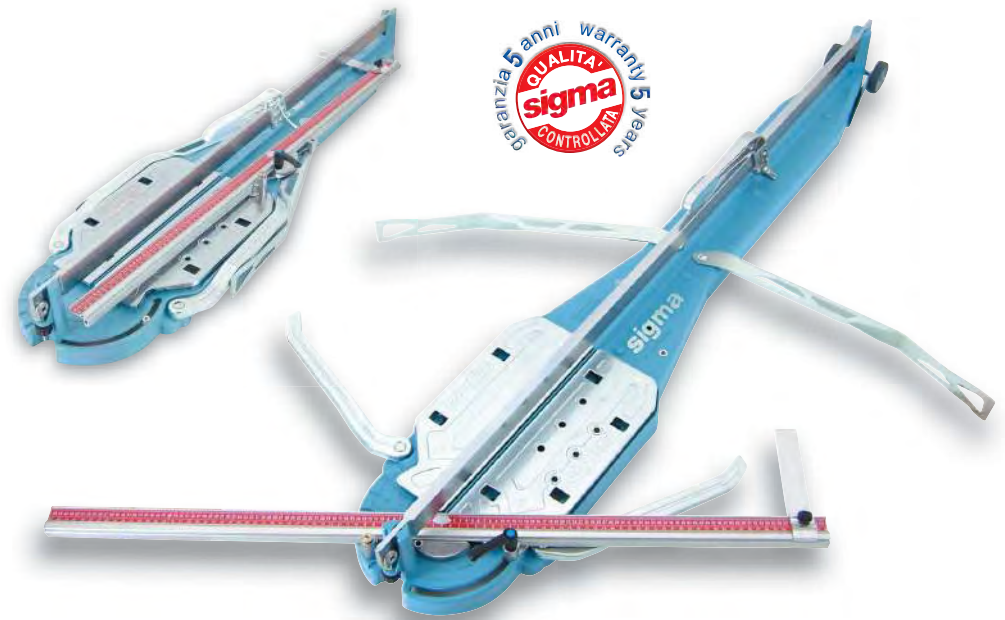

🇮🇹 Tagliapiastrelle

🇫🇷 Coupe Carreaux

🇬🇧 Tile Cutters

🇩🇪 Fliesenschneider

sigma
di Ambrogiani

🇮🇹 » SERIE 3 KLICK KLOCK » incisione a spinta , facile e profonda

🇬🇧 » SERIE 3 KLICK KLOCK » incision to push, easy and deep

🇫🇷 » SERIE 3 KLICK KLOCK » incision à pousser, facile et profonde

🇩🇪 » SERIE 3 KLICK KLOCK » Incision zu drücken, einfach und tief

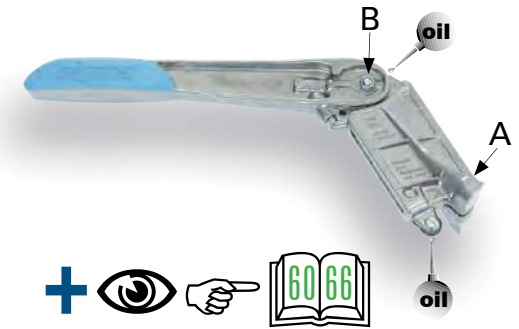

- Art. 3GK cm.42
- Art. 3LK cm.52
- Art. 3B2K cm.62
- Art. 3C2K cm.74
- Art. 3D2K cm.92
- Art. 3P2K cm.102
- Art. 3E2K cm.128

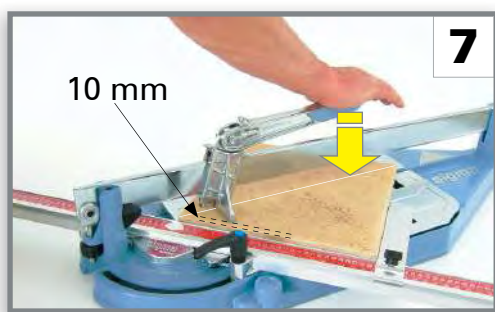
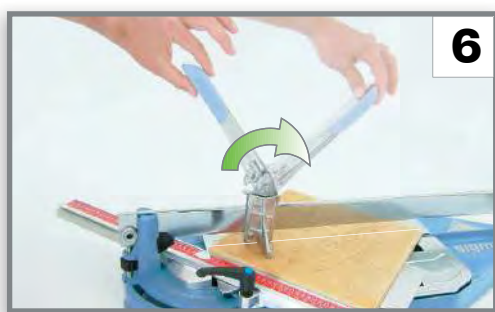
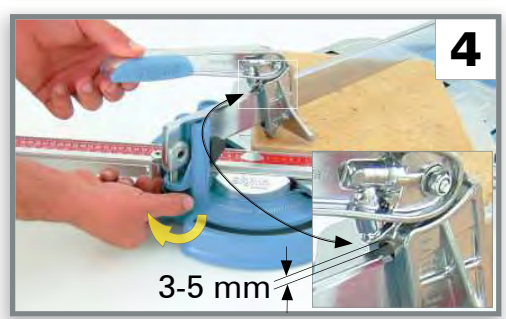
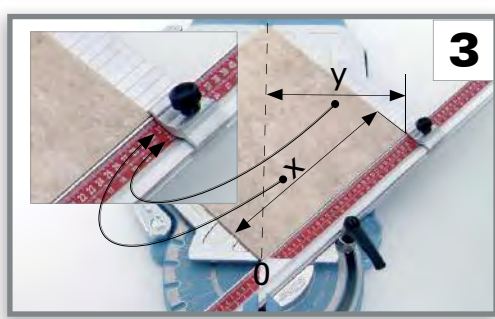
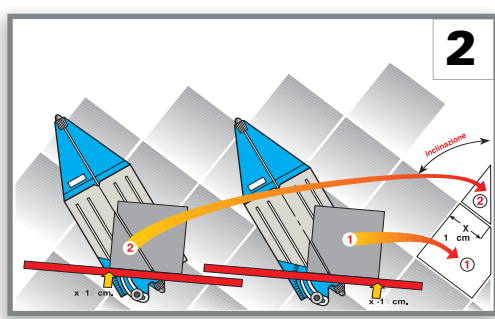
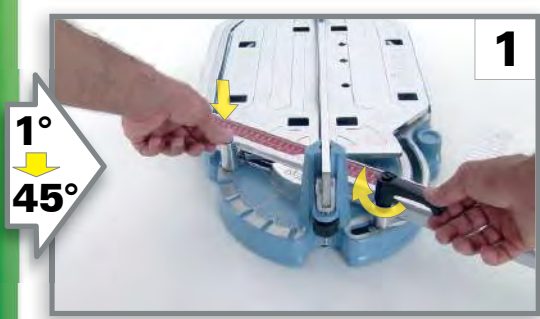
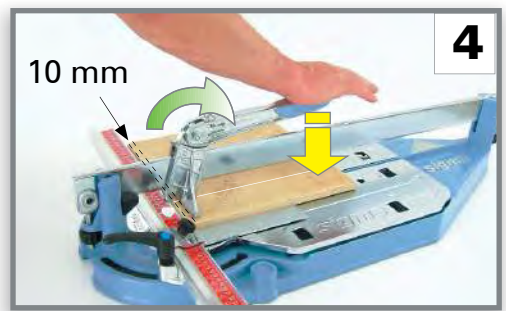
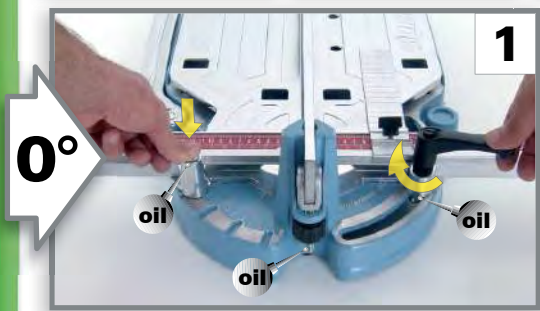

- 🇮🇹 trasporto
- 🇬🇧 transport
- 🇫🇷 le transport
- 🇩🇪 Transport

🇮🇹 " SERIE 3 KLICK KLOCK " incisione a spinta

🇫🇷 " SERIE 3 KLICK KLOCK " incision à pousser

🇬🇧 " SERIE 3 KLICK KLOCK " incision by pushing

🇩🇪 " SERIE 3 KLICK KLOCK " Incision zu drücken

sigma
di Ambrogiani

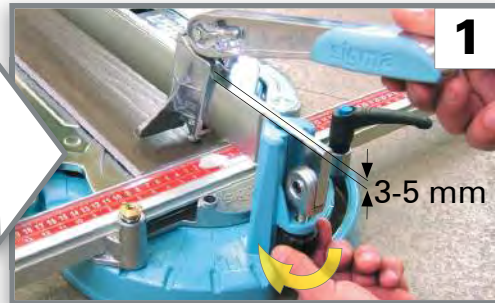
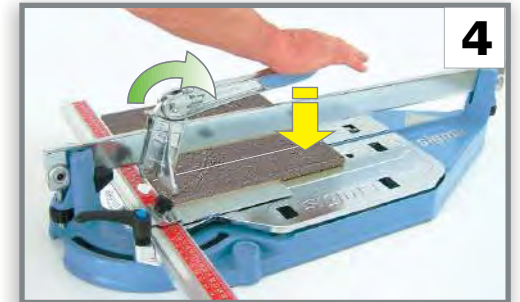
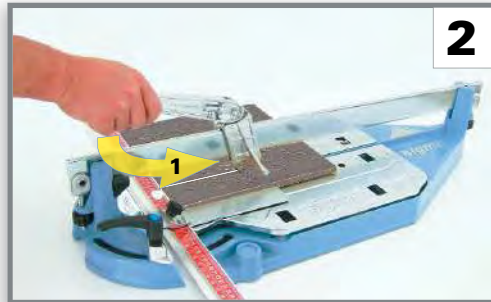

Art. 3E2K cm.128



www.youtube.com/valterambro

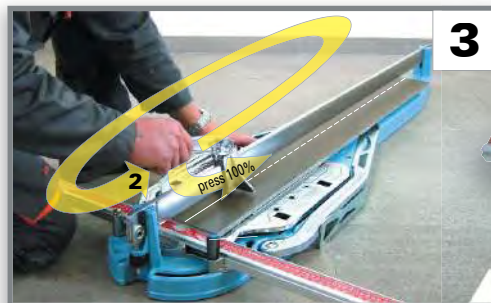
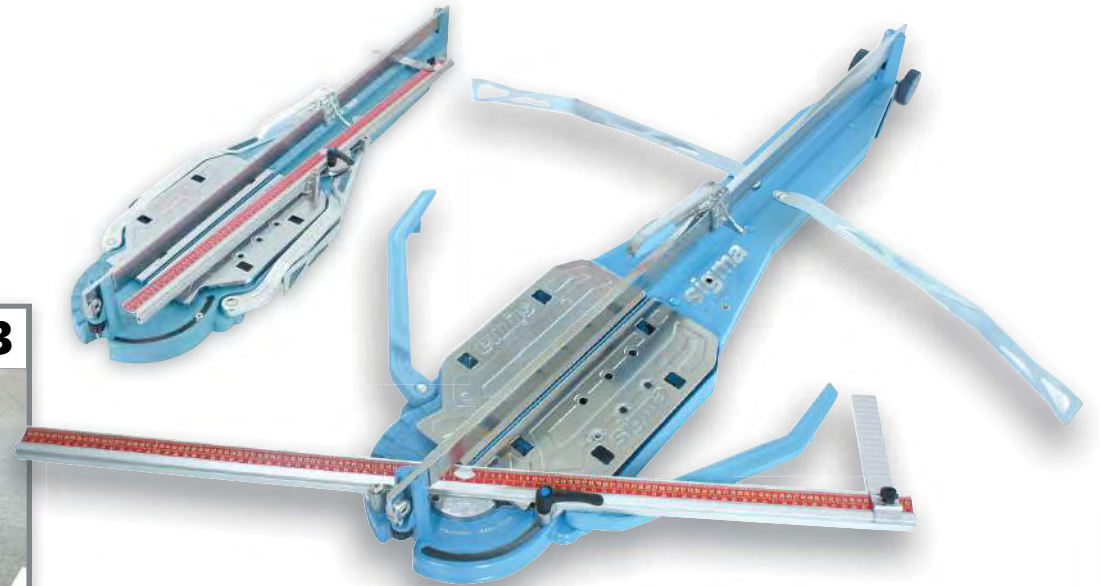

Tagliapiastrelle

Coupe Carreaux

Tile Cutters

Fliesenschneider

sigma
di Ambrogiani

» TECNICA » incisione veloce a trazione

» TECNICA » fast incision to pull

» TECNICA » incision rapide à tirer

» TECNICA » schnellen Einschnitt zu Pull

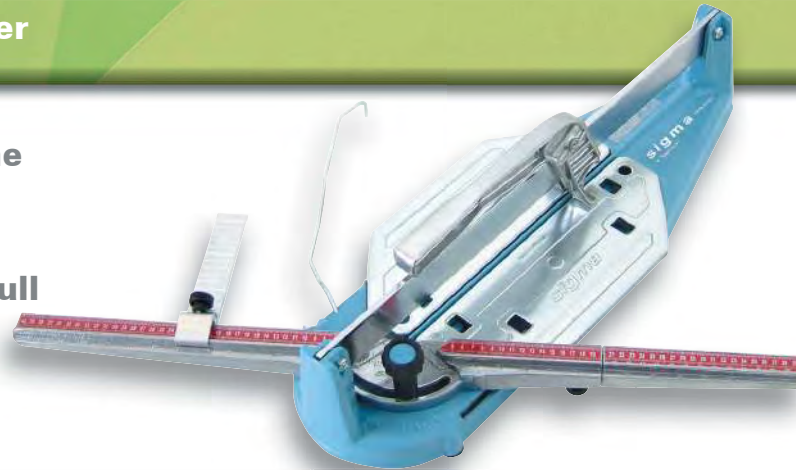

Art. 2A3 cm.51

Art. 2B3 cm.66

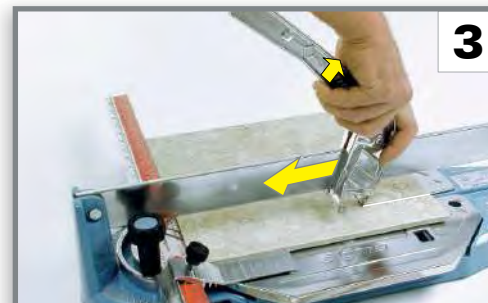
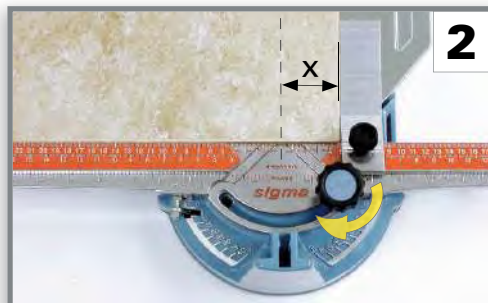
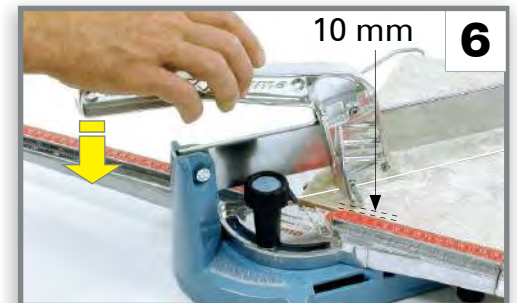
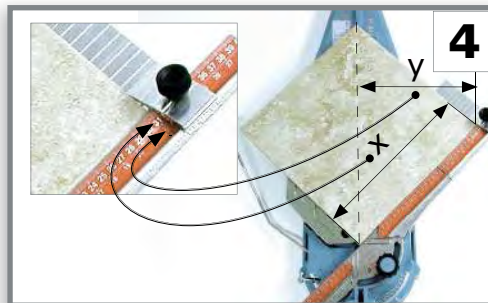
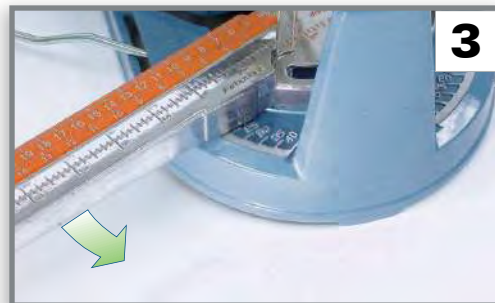
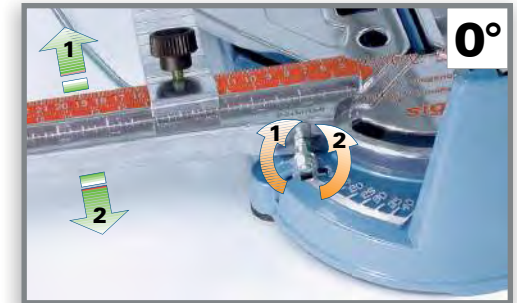
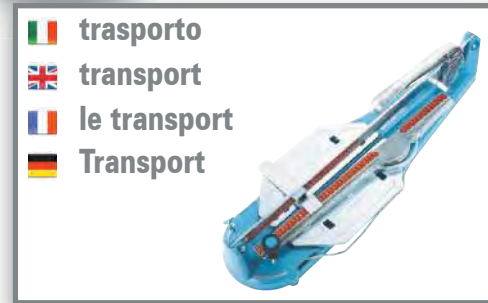
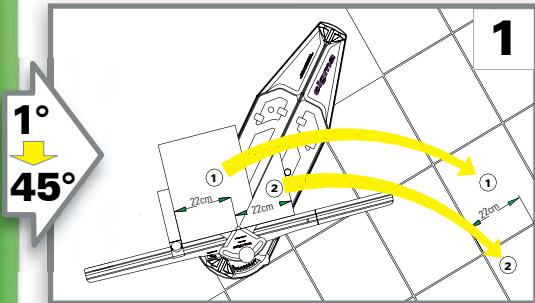
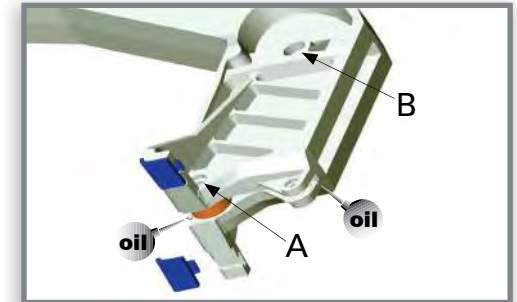

🇮🇹 Tagliapiastrelle

🇫🇷 Coupe Carreaux

🇬🇧 Tile Cutters

🇩🇪 Fliesenschneider

sigma
di Ambrogiani

- 🇮🇹 » **TECNICA** » incisione a spinta , facile e profonda
- 🇬🇧 » **TECNICA** » incision to push, easy and deep
- 🇫🇷 » **TECNICA** » incision à pousser, facile et profonde
- 🇩🇪 » **TECNICA** » Einschnitt zu drücken, einfach und tief

Art. 2C4 cm.46

Art. 2D4 cm.61



www.youtube.com/valterambro

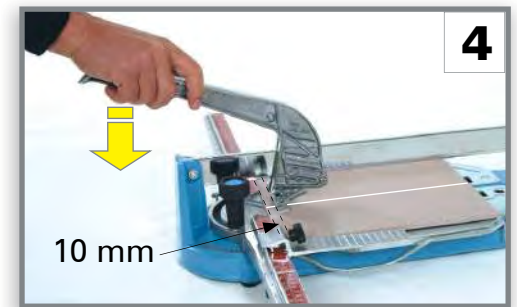
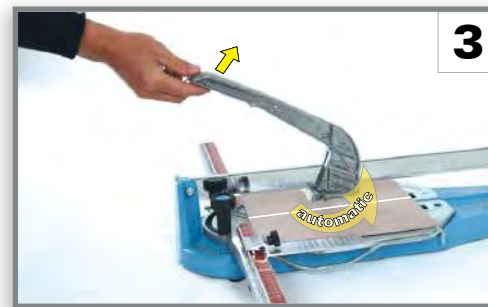
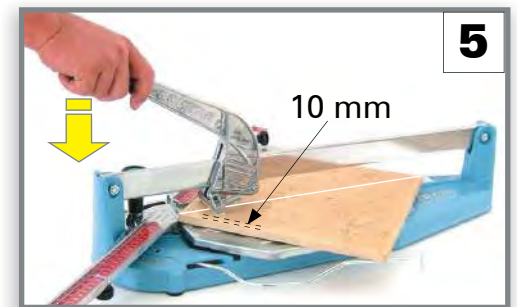
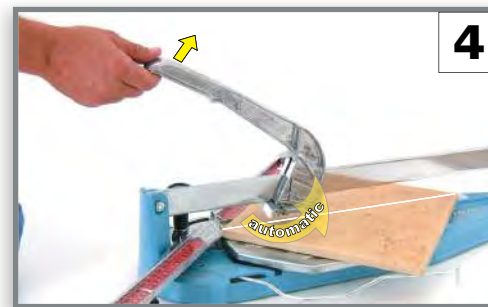
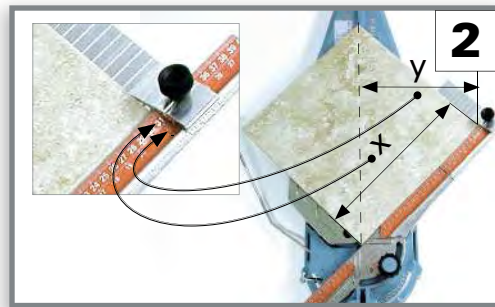
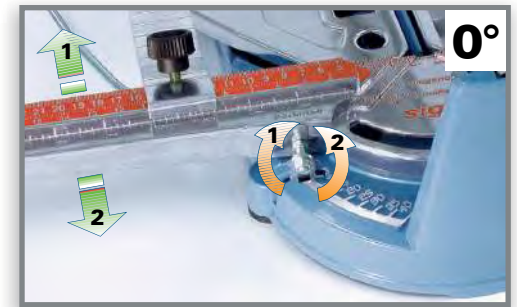
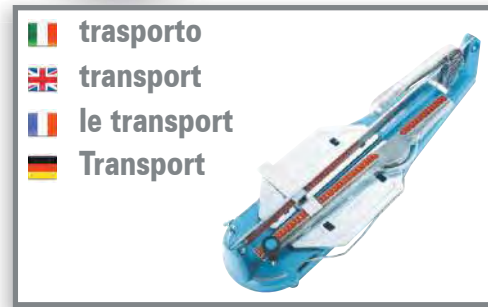
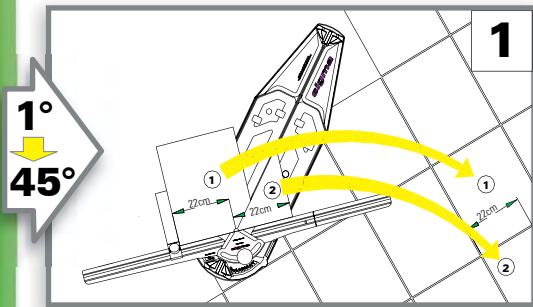
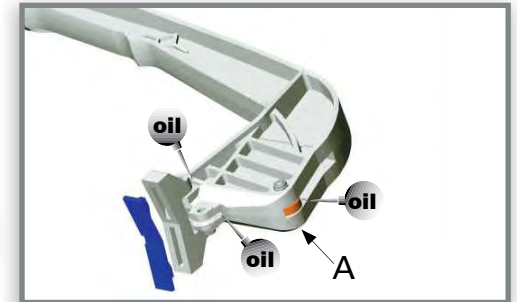
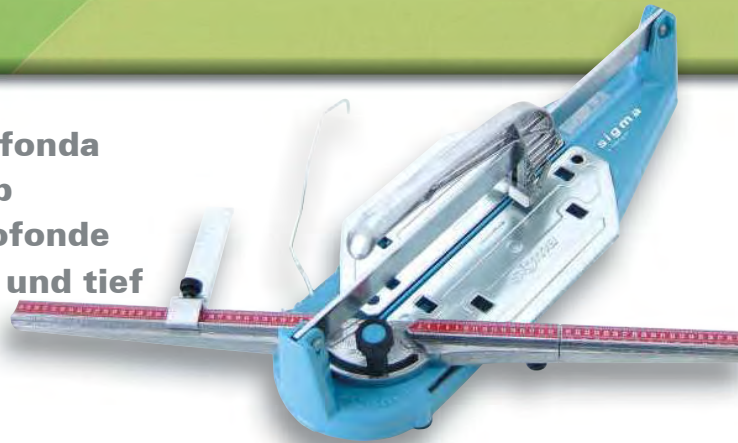

Tagliapiastrelle

Coupe Carreaux

Tile Cutters

Fliesenschneider

sigma
di Ambrogiani

- » **DIAGONALE** » incisione a trazione, pratica e veloce
- » **DIAGONALE** » incision to pull, fast and practical
- » **DIAGONALE** » incision à tirer, rapide et pratique
- » **DIAGONALE** » Einschnitt zu Pull, schnell und praktisch

Art. 5A cm.51

Art. 5B cm.62

Art. 4A cm.75

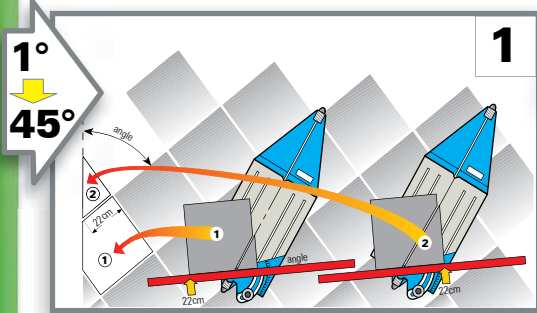
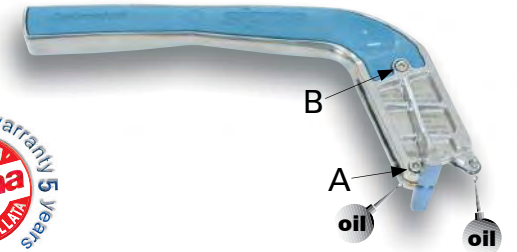

www.youtube.com/valterambro

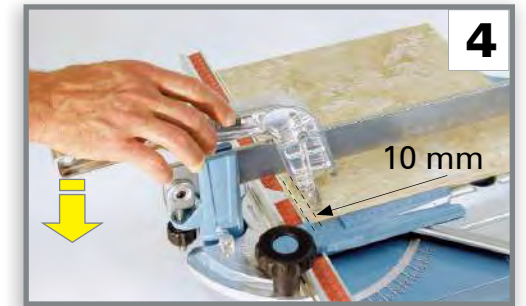
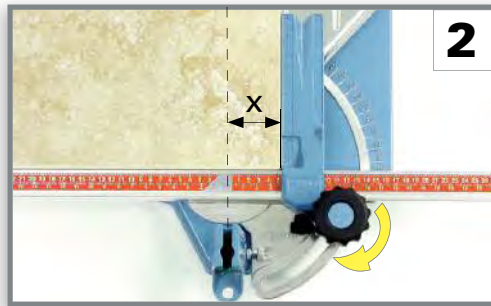
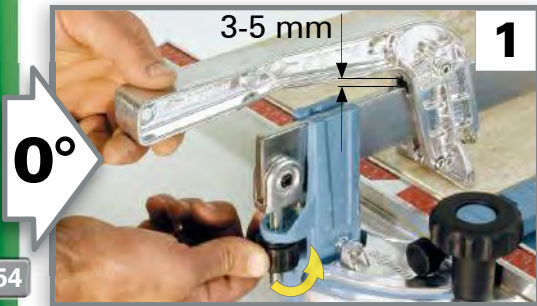
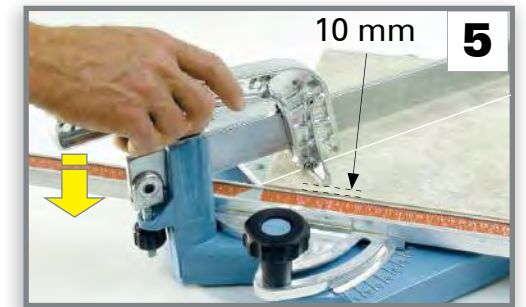
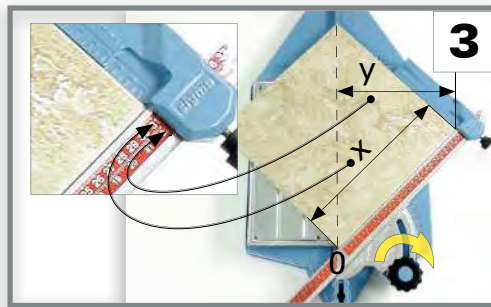
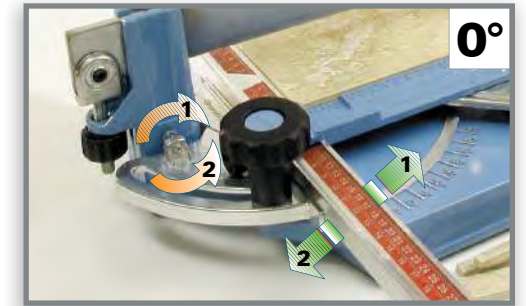

- 🇮🇹 » **STANDARD** » incisione a trazione, pratica e veloce
- 🇩🇪 » **STANDARD** » Einschnitt zu Pull, schnell und praktisch
- 🇬🇧 » **STANDARD** » incision to pull, fast and practical
- 🇫🇷 » **STANDARD** » incision à tirer, rapide et pratique



www.youtube.com/valterambro

Art. 7A cm.33



Art. 7F cm.37

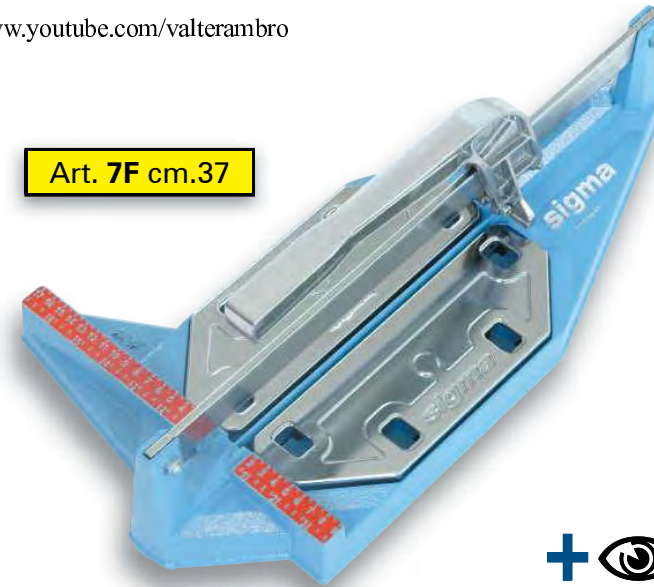

0°

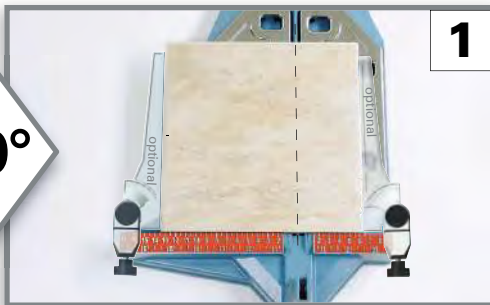

1



2

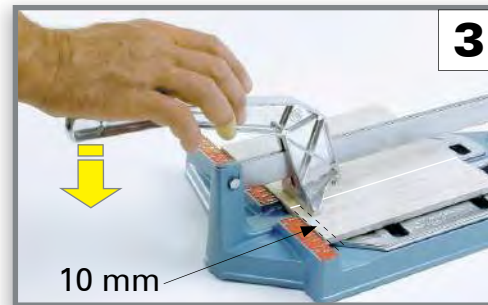

3

10 mm

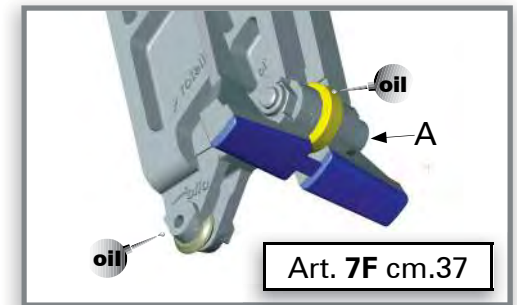

Art. 7F cm.37

1°
45°

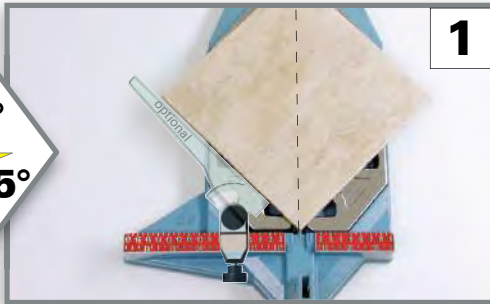

1



2



3

10 mm

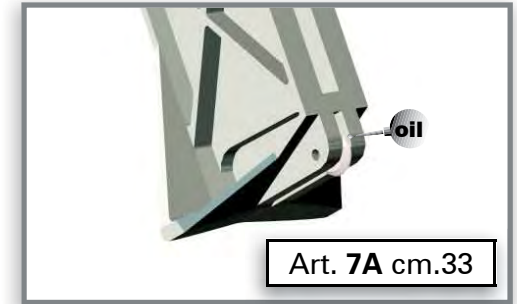

Art. 7A cm.33

🇮🇹 Tagliapiastrelle

🇫🇷 Coupe Carreaux

🇬🇧 Tile Cutters

🇩🇪 Fliesenschneider

sigma
di Ambrogiani

- 🇮🇹 "STANDARD" incisione veloce a trazione
- 🇩🇪 "STANDARD" schnellen Einschnitt zu Pull
- 🇬🇧 "STANDARD" fast incision to pull
- 🇫🇷 "STANDARD" incision rapide à tirer



Art. 5 cm.50



Art. 6 cm.35

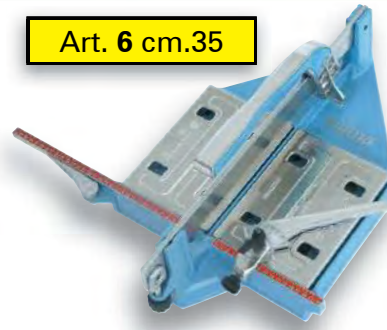

www.youtube.com/valterambro

