

200AC/DC

**INVERTER
ARC WELDING MACHINE**



A-11217

Operating Manual

Revision: AC
Operating Features:

Issue Date: August 15, 2012

Manual No: 0-5207





WE APPRECIATE YOUR BUSINESS!

Congratulations on your new CIGWELD product. We are proud to have you as our customer and will strive to provide you with the best service and reliability in the industry. This product is backed by our extensive warranty and world-wide service network. To locate your nearest distributor or Accredited Service Provider call +1300 654 674, or visit us on the web at www.cigweld.com.au

This Operating Manual has been designed to instruct you on the correct use and operation of your CIGWELD product. Your satisfaction with this product and its safe operation is our ultimate concern. Therefore please take the time to read the entire manual, especially the Safety Precautions. They will help you to avoid potential hazards that may exist when working with this product.

YOU ARE IN GOOD COMPANY!

The Brand of Choice for Contractors and Fabricators Worldwide.

CIGWELD is the Market Leading Brand of Arc Welding Products for Victor Technologies Inc. We are a mainline supplier to major welding industry sectors in the Asia Pacific and emerging global markets including; Manufacturing, Construction, Mining, Automotive, Engineering, Rural and DIY.

We distinguish ourselves from our competition through market-leading, dependable products that have stood the test of time. We pride ourselves on technical innovation, competitive prices, excellent delivery, superior customer service and technical support, together with excellence in sales and marketing expertise.

Above all, we are committed to develop technologically advanced products to achieve a safer working environment for industry operators.



WARNINGS

Read and understand this entire Manual and your employer's safety practices before installing, operating, or servicing the equipment.

While the information contained in this Manual represents the Manufacturer's best judgement, the Manufacturer assumes no liability for its use.

Welding Power Supply
Operating Manual Number 0-5207 for:

WeldSkill 200AC/DC Plant Part Number W1006200

Published by:
CIGWELD Pty Ltd
71 Gower Street
Preston, Victoria, Australia, 3072

www.cigweld.com.au

Copyright 2012 by
CIGWELD

All rights reserved.

Reproduction of this work, in whole or in part, without written permission of the publisher is prohibited.

The publisher does not assume and hereby disclaims any liability to any party for any loss or damage caused by any error or omission in this Manual, whether such error results from negligence, accident, or any other cause.

Publication Date: March 15, 2012
Revision AC Date: August 15, 2012

Record the following information for Warranty purposes:

Where Purchased: _____

Purchase Date: _____

Equipment Serial #: _____

TABLE OF CONTENTS

SECTION 1:

ARC WELDING SAFETY INSTRUCTIONS AND WARNINGS 1-1

1.01	Arc Welding Hazards.....	1-1
1.02	Principal Safety Standards.....	1-5
1.03	Declaration of Conformity.....	1-6

SECTION 2:

INTRODUCTION 2-1

2.01	How To Use This Manual	2-1
2.02	Equipment Identification.....	2-1
2.03	Receipt of Equipment.....	2-1
2.04	Symbol Chart.....	2-2
2.05	Description	2-3
2.06	User Responsibility.....	2-3
2.07	Transporting Methods.....	2-3
2.08	Packaged Items	2-3
2.09	Duty Cycle.....	2-4
2.10	Specifications	2-5
2.11	Options and Accessories	2-6

SECTION 3:

INSTALLATION, OPERATION AND SETUP 3-1

3.01	Environment	3-1
3.02	Location.....	3-1
3.03	Ventilation.....	3-1
3.04	Mains Supply Voltage Requirements	3-1
3.05	High Frequency Introduction	3-1
3.06	High Frequency Interference.....	3-2
3.07	Electromagnetic Compatibility	3-2
3.08	WELDSKILL 200AC/DC Power Source Controls, Indicators and Features.....	3-4
3.09	WELDSKILL 200AC/DC - STICK Programming Mode	3-8
3.10	WELDSKILL 200AC/DC – LIFT TIG and HF TIG Programming Mode	3-10
3.11	Short Circuit Protection While Welding.....	3-13
3.12	Shielding Gas Regulator Operating Instructions	3-13
3.13	Setup for TIG (GTAW) Welding	3-15
3.14	Foot Control, Part No. W4015800 (Optional Accessory)	3-17
3.15	Setup for STICK (MMAW) Welding	3-19

SECTION 4:

BASIC WELDING GUIDE 4-1

4.01	Stick (MMAW) Basic Welding Technique	4-1
4.02	Stick (MMAW) Welding Troubleshooting.....	4-12
4.03	TIG (GTAW) Basic Welding Technique	4-14
4.04	TIG (GTAW) Welding Problems.....	4-16

TABLE OF CONTENTS

SECTION 5:		
	POWER SOURCE PROBLEMS AND ROUTINE SERVICE REQUIREMENTS	5-1
5.01	Basic Troubleshooting	5-1
5.02	Power Source Problems	5-1
5.03	Routine Service and Calibration Requirements	5-2
5.04	Cleaning the Welding Power Source	5-4
SECTION 6:		
	KEY SPARE PARTS.....	6-1
6.01	Power Source	6-1
	APPENDIX: CIRCUIT DIAGRAM.....	A-1
	CIGWELD - LIMITED WARRANTY TERMS	
	TERMS OF WARRANTY – January 2012	
	WARRANTY SCHEDULE – January 2012	
	GLOBAL CUSTOMER SERVICE CONTACT INFORMATION	

SECTION 1: ARC WELDING SAFETY INSTRUCTIONS AND WARNINGS



WARNING

PROTECT YOURSELF AND OTHERS FROM POSSIBLE SERIOUS INJURY OR DEATH. KEEP CHILDREN AWAY. PACEMAKER WEARERS KEEP AWAY UNTIL CONSULTING YOUR DOCTOR. DO NOT LOSE THESE INSTRUCTIONS. READ OPERATING/INSTRUCTION MANUAL BEFORE INSTALLING, OPERATING OR SERVICING THIS EQUIPMENT.

Welding products and welding processes can cause serious injury or death, or damage to other equipment or property, if the operator does not strictly observe all safety rules and take precautionary actions.

Safe practices have developed from past experience in the use of welding and cutting. These practices must be learned through study and training before using this equipment. Some of these practices apply to equipment connected to power lines; other practices apply to engine driven equipment. Anyone not having extensive training in welding and cutting practices should not attempt to weld.

Safe practices are outlined in the Australian Standard AS1674.2-2007 entitled: Safety in welding and allied processes Part 2: Electrical. This publication and other guides to what you should learn before operating this equipment are listed at the end of these safety precautions. **HAVE ALL INSTALLATION, OPERATION, MAINTENANCE, AND REPAIR WORK PERFORMED ONLY BY QUALIFIED PEOPLE.**

1.01 Arc Welding Hazards



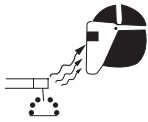
WARNING

ELECTRIC SHOCK can kill.

Touching live electrical parts can cause fatal shocks or severe burns. The electrode and work circuit is electrically live whenever the output is on. The input power circuit and machine internal circuits are also live when power is on. In semiautomatic or automatic wire welding, the wire, wire reel, drive roll housing, and all metal parts touching the welding wire are electrically live. Incorrectly installed or improperly grounded equipment is a hazard.

1. Do not touch live electrical parts.
2. Wear dry, hole-free insulating gloves and body protection.
3. Insulate yourself from work and ground using dry insulating mats or covers.
4. Disconnect input power or stop engine before installing or servicing this equipment. Lock input power disconnect switch open, or remove line fuses so power cannot be turned on accidentally.
5. Properly install and ground this equipment according to its Owner's Manual and national, state, and local codes.
6. Turn off all equipment when not in use. Disconnect power to equipment if it will be left unattended or out of service.
7. Use fully insulated electrode holders. Never dip holder in water to cool it or lay it down on the ground or the work surface. Do not touch holders connected to two welding machines at the same time or touch other people with the holder or electrode.
8. Do not use worn, damaged, undersized, or poorly spliced cables.
9. Do not wrap cables around your body.
10. Ground the workpiece to a good electrical (earth) ground.
11. Do not touch electrode while in contact with the work (ground) circuit.
12. Use only well-maintained equipment. Repair or replace damaged parts at once.
13. In confined spaces or damp locations, do not use a welder with AC output unless it is equipped with a voltage reducer. Use equipment with DC output.
14. Wear a safety harness to prevent falling if working above floor level.
15. Keep all panels and covers securely in place.

WELDSKILL 200 AC/DC INVERTER



WARNING

ARC RAYS can burn eyes and skin; NOISE can damage hearing.

Arc rays from the welding process produce intense heat and strong ultraviolet rays that can burn eyes and skin. Noise from some processes can damage hearing.

1. Use a Welding Helmet or Welding Faceshield fitted with a proper shade of filter (see ANSI Z49.1 and AS 1674 listed in Safety Standards) to protect your face and eyes when welding or watching.
2. Wear approved safety glasses. Side shields recommended.
3. Use protective screens or barriers to protect others from flash and glare; warn others not to watch the arc.
4. Wear protective clothing made from durable, flame-resistant material (wool and leather) and foot protection.
5. Use approved ear plugs or ear muffs if noise level is high.
6. Never wear contact lenses while welding.

Recommended Protective Filters for Electric Welding		
Description of Process	Approximate Range of Welding Current in Amps	Minimum Shade Number of Filter(s)
Manual Metal Arc Welding - covered electrodes (MMAW)	Less than or equal to 100	8
	100 to 200	10
	200 to 300	11
	300 to 400	12
	Greater than 400	13
Gas Metal Arc Welding (GMAW) (MIG) other than Aluminium and Stainless Steel	Less than or equal to 150	10
	150 to 250	11
	250 to 300	12
	300 to 400	13
	Greater than 400	14
Gas Metal Arc Welding (GMAW) (MIG) Aluminium and Stainless Steel	Less than or equal to 250	12
	250 to 350	13
Gas Tungsten Arc Welding (GTAW) (TIG)	Less than or equal to 100	10
	100 to 200	11
	200 to 250	12
	250 to 350	13
	Greater than 350	14
Flux-cored Arc Welding (FCAW) -with or without shielding gas.	Less than or equal to 300	11
	300 to 400	12
	400 to 500	13
	Greater than 500	14
Air - Arc Gouging	Less than or equal to 400	12
Plasma - Arc Cutting	50 to 100	10
	100 to 400	12
	400 to 800	14
Plasma - Arc Spraying	—	15
Plasma - Arc Welding	Less than or equal to 20	8
	20 to 100	10
	100 to 400	12
	400 to 800	14
Submerged - Arc Welding	—	2(5)
Resistance Welding	—	Safety Spectacles or eye shield

Refer to standard AS/NZS 1338.1:1992 for comprehensive information regarding the above table.

**WARNING**

FUMES AND GASES can be hazardous to your health.

Welding produces fumes and gases. Breathing these fumes and gases can be hazardous to your health.

1. Keep your head out of the fumes. Do not breathe the fumes.
2. If inside, ventilate the area and/or use exhaust at the arc to remove welding fumes and gases.
3. If ventilation is poor, use an approved air-supplied respirator.
4. Read the Material Safety Data Sheets (MSDSs) and the manufacturer's instruction for metals, consumables, coatings, and cleaners.
5. Work in a confined space only if it is well ventilated, or while wearing an air-supplied respirator. Shielding gases used for welding can displace air causing injury or death. Be sure the breathing air is safe.
6. Do not weld in locations near degreasing, cleaning, or spraying operations. The heat and rays of the arc can react with vapours to form highly toxic and irritating gases.
7. Do not weld on coated metals, such as galvanized, lead, or cadmium plated steel, unless the coating is removed from the weld area, the area is well ventilated, and if necessary, while wearing an air-supplied respirator. The coatings and any metals containing these elements can give off toxic fumes if welded.

**WARNING**

WELDING can cause fire or explosion.

Sparks and spatter fly off from the welding arc. The flying sparks and hot metal, weld spatter, hot workpiece, and hot equipment can cause fires and burns. Accidental contact of electrode or welding wire to metal objects can cause sparks, overheating, or fire.

1. Protect yourself and others from flying sparks and hot metal.
2. Do not weld where flying sparks can strike flammable material.

3. Remove all flammables within 35 ft (10.7 m) of the welding arc. If this is not possible, tightly cover them with approved covers.
4. Be alert that welding sparks and hot materials from welding can easily go through small cracks and openings to adjacent areas.
5. Watch for fire, and keep a fire extinguisher nearby.
6. Be aware that welding on a ceiling, floor, bulkhead, or partition can cause fire on the hidden side.
7. Do not weld on closed containers such as tanks or drums.
8. Connect work cable to the work as close to the welding area as practical to prevent welding current from travelling long, possibly unknown paths and causing electric shock and fire hazards.
9. Do not use welder to thaw frozen pipes.
10. Remove stick electrode from holder or cut off welding wire at contact tip when not in use.

**WARNING**

FLYING SPARKS AND HOT METAL can cause injury.

Chipping and grinding cause flying metal. As welds cool, they can throw off slag.

1. Wear approved face shield or safety goggles. Side shields recommended.
2. Wear proper body protection to protect skin.

**WARNING**

CYLINDERS can explode if damaged.

Shielding gas cylinders contain gas under high pressure. If damaged, a cylinder can explode. Since gas cylinders are normally part of the welding process, be sure to treat them carefully.

1. Protect compressed gas cylinders from excessive heat, mechanical shocks, and arcs.
2. Install and secure cylinders in an upright position by chaining them to a stationary support or equipment cylinder rack to prevent falling or tipping.
3. Keep cylinders away from any welding or other electrical circuits.
4. Never allow a welding electrode to touch any cylinder.

WELDSKILL 200 AC/DC INVERTER

5. Use only correct shielding gas cylinders, regulators, hoses, and fittings designed for the specific application; maintain them and associated parts in good condition.
6. Turn face away from valve outlet when opening cylinder valve.
7. Keep protective cap in place over valve except when cylinder is in use or connected for use.
8. Read and follow instructions on compressed gas cylinders, associated equipment, and CGA publication P-1 listed in Safety Standards.



WARNING

MOVING PARTS can cause injury.

Moving parts, such as fans, rotors, and belts can cut fingers and hands and catch loose clothing.

1. Keep all doors, panels, covers, and guards closed and securely in place.
2. Stop engine before installing or connecting unit.
3. Have only qualified people remove guards or covers for maintenance and troubleshooting as necessary.
4. To prevent accidental starting during servicing, disconnect negative (-) battery cable from battery.
5. Keep hands, hair, loose clothing, and tools away from moving parts.
6. Reinstall panels or guards and close doors when servicing is finished and before starting engine.



WARNING

This product, when used for welding or cutting, produces fumes or gases which contain chemicals known to the State of California to cause birth defects and, in some cases, cancer. (California Health & Safety code Sec. 25249.5 et seq.)

NOTE

Considerations About Welding And The Effects of Low Frequency Electric and Magnetic Fields

The following is a quotation from the General Conclusions Section of the U.S. Congress, Office of Technology Assessment, Biological Effects of Power Frequency Electric & Magnetic Fields - Background Paper, OTA-BP-E-63 (Washington, DC: U.S. Government Printing Office, May 1989): "...there is now a very large volume of scientific findings based on experiments at the cellular level and from studies with animals and people which clearly establish that low frequency magnetic fields and interact with, and produce changes in, biological systems. While most of this work is of very high quality, the results are complex. Current scientific understanding does not yet allow us to interpret the evidence in a single coherent framework. Even more frustrating, it does not yet allow us to draw definite conclusions about questions of possible risk or to offer clear science-based advice on strategies to minimize or avoid potential risks."

To reduce magnetic fields in the workplace, use the following procedures.

1. Keep cables close together by twisting or taping them.
2. Arrange cables to one side and away from the operator.
3. Do not coil or drape cable around the body.
4. Keep welding power source and cables as far away from body as practical.



ABOUT PACEMAKERS:

The above procedures are among those also normally recommended for pacemaker wearers. Consult your doctor for complete information.

1.02 Principal Safety Standards

Safety in Welding and Cutting, ANSI Standard Z49.1, from American Welding Society, 550 N.W. LeJeune Rd., Miami, FL 33126.

Safety and Health Standards, OSHA 29 CFR 1910, from Superintendent of Documents, U.S. Government Printing Office, Washington, D.C. 20402.

Recommended Safe Practices for the Preparation for Welding and Cutting of Containers That Have Held Hazardous Substances, American Welding Society Standard AWS F4.1, from American Welding Society, 550 N.W. LeJeune Rd., Miami, FL 33126.

National Electrical Code, NFPA Standard 70, from National Fire Protection Association, Batterymarch Park, Quincy, MA 02269.

Safe Handling of Compressed Gases in Cylinders, CGA Pamphlet P-1, from Compressed Gas Association, 1235 Jefferson Davis Highway, Suite 501, Arlington, VA 22202.

Code for Safety in Welding and Cutting, CSA Standard W117.2, from Canadian Standards Association, Standards Sales, 178 Rexdale Boulevard, Rexdale, Ontario, Canada M9W 1R3.

Safe Practices for Occupation and Educational Eye and Face Protection, ANSI Standard Z87.1, from American National Standards Institute, 1430 Broadway, New York, NY 10018.

Cutting and Welding Processes, NFPA Standard 51B, from National Fire Protection Association, Batterymarch Park, Quincy, MA 02269.

Safety in welding and allied processes Part 1: Fire Precautions, AS 1674.1-1997 from SAI Global Limited, www.saiglobal.com.

Safety in welding and allied processes Part 2: Electrical, AS 1674.2-2007 from SAI Global Limited, www.saiglobal.com.

Filters for eye protectors - Filters for protection against radiation generated in welding and allied operations AS/NZS 1338.1:1992 from SAI Global Limited, www.saiglobal.com.

WELDSKILL 200 AC/DC INVERTER

1.03 Declaration of Conformity

Manufacturer and Merchandiser of Quality Consumables and Equipment :
Address:

CIGWELD
71 Gower St, Preston
Victoria 3072
Australia



Description of equipment: CIGWELD WeldSkill 200AC/DC INVERTER Power Source and associated accessories.

* Serial numbers are unique with each individual piece of equipment and details description, parts used to manufacture a unit and date of manufacture.

* The equipment conforms to all applicable aspects and regulations of the 'Low Voltage Directive' (Directive 73/23/EU, as recently changed in Directive 93/68/EU and to the National legislation for the enforcement of the Directive.

National Standard and Technical Specifications

The product is designed and manufactured to a number of standards and technical requirements among them are:

* AS 60974.10/ IEC 60974-10 EMC Directive applicable to arc welding equipment - generic emissions and regulations.

* AS 60974.1-2006 /IEC 60974-1 applicable to welding equipment and associated accessories.

* AS1674. Safety in welding and allied processes

* Extensive product design verification is conducted at the manufacturing facility as part of the routine design and manufacturing process, to ensure the product is safe and performs as specified. Rigorous testing is incorporated into the manufacturing process to ensure the manufactured product meets or exceeds all design specifications.

CIGWELD has been manufacturing and merchandising an extensive equipment range with superior performance, ultra safe operation and world class quality for more than 30 years and will continue to achieve excellence.

SECTION 2: INTRODUCTION

2.01 How To Use This Manual

To ensure safe operation, read the entire manual, including the chapter on safety instructions and warnings.

Throughout this manual, the words WARNING, CAUTION, and NOTE may appear. Pay particular attention to the information provided under these headings. These special annotations are easily recognized as follows:



WARNING

A WARNING gives information regarding possible personal injury.



CAUTION

A CAUTION refers to possible equipment damage.

NOTE

A NOTE offers helpful information concerning certain operating procedures.

Additional copies of this manual may be purchased by contacting CIGWELD at the address and phone number for your location listed in the inside back cover of this manual. Include the Owner's Manual number and equipment identification numbers.

2.02 Equipment Identification

The unit's identification number (specification or part number), model, and serial number usually appear on a nameplate attached to the control panel. In some cases, the nameplate may be attached to the rear panel. Equipment which does not have a control panel such as gun and cable assemblies is identified only by the specification or part number printed on the shipping container. Record these numbers on the bottom of page ii for future reference.

2.03 Receipt of Equipment

When you receive the equipment, check it against the invoice to make sure it is complete and inspect the equipment for possible damage due to shipping. If there is any damage, notify the carrier immediately to file a claim. Furnish complete information concerning damage claims or shipping errors to the location in your area listed in the inside back cover of this manual.
















Include all equipment identification numbers as described above along with a full description of the parts in error.


















Move the equipment to the installation site before un-crating the unit. Use care to avoid damaging the equipment when using bars, hammers, etc., to uncrate the unit.














WELDSKILL 200AC/DC INVERTER

2.04 Symbol Chart

Note that only some of these symbols will appear on your model.

	On
	Off
	Dangerous Voltage
	Increase/Decrease
	Circuit Breaker
	AC Auxiliary Power
	Fuse
A	Amperage
V	Voltage
Hz	Hertz (cycles/sec)
f	Frequency
	Negative
	Positive
	Direct Current (DC)
	Protective Earth (Ground)
	Line
	Line Connection
	Auxiliary Power
115V 15A 	Receptacle Rating- Auxiliary Power

1 	Single Phase
3 	Three Phase
	Three Phase Static Frequency Converter- Transformer-Rectifier
	Remote
X	Duty Cycle
%	Percentage
	Panel/Local
	Shielded Metal Arc Welding (SMAW)
	Gas Metal Arc Welding (GMAW)
	Gas Tungsten Arc Welding (GTAW)
	Air Carbon Arc Cutting (CAC-A)
	Constant Current
	Constant Voltage Or Constant Potential
	High Temperature
	Fault Indication
	Arc Force
	Touch Start (GTAW)
	Variable Inductance
	Voltage Input

	Wire Feed Function
	Wire Feed Towards Workpiece With Output Voltage Off.
	Welding Gun
	Purging Of Gas
	Continuous Weld Mode
	Spot Weld Mode
	Spot Time
	Preflow Time
	Postflow Time
	2 Step Trigger Operation Press to initiate wirefeed and welding, release to stop.
	4 Step Trigger Operation Press and hold for preflow, release to start arc. Press to stop arc, and hold for preflow.
	Burnback Time
	Disturbance In Ground System
IPM	Inches Per Minute
MPM	Meters Per Minute

Art# A-04937

2.05 Description

The CIGWELD WELDSKILL 200AC/DC is a single phase constant current welding inverter capable of performing MMAW (Stick), GTAW (HF TIG) and GTAW (Lift TIG) welding processes. The unit is equipped with digital amperage and voltage meters, and a host of other features in order to fully satisfy the broad operating needs of the modern user. The unit is also fully compliant to Australian Standard AS 60974.1 and IEC 60974.1.

The WELDSKILL 200AC/DC provides excellent welding performance across a broad range of applications when used with the correct welding consumables and procedures. The following instructions detail how to correctly and safely set up the machine and give guidelines on gaining the best efficiency and quality from the Power Source. Please read these instructions thoroughly before using the unit.

2.06 User Responsibility

This equipment will perform as per the information contained herein when installed, operated, maintained and repaired in accordance with the instructions provided. This equipment must be checked periodically. Defective equipment (including welding leads) should not be used. Parts that are broken, missing, plainly worn, distorted or contaminated, should be replaced immediately. Should such repairs or replacements become necessary, it is recommended that such repairs be carried out by appropriately qualified persons approved by CIGWELD. Advice in this regard can be obtained by contacting an Accredited CIGWELD Distributor.

This equipment or any of its parts should not be altered from standard specification without prior written approval of CIGWELD. The user of this equipment shall have the sole responsibility for any malfunction which results from improper use or unauthorized modification from standard specification, faulty maintenance, damage or improper repair by anyone other than appropriately qualified persons approved by CIGWELD.

2.07 Transporting Methods

This unit is equipped with a handle for carrying purposes.

**WARNING**

ELECTRIC SHOCK can kill. DO NOT TOUCH live electrical parts. Disconnect input power conductors from de-energized supply line before moving the welding power source.

**WARNING**

FALLING EQUIPMENT can cause serious personal injury and equipment damage.

Lift unit with handle on top of case.

Use handcart or similar device of adequate capacity.

If using a fork lift vehicle, place and secure unit on a proper skid before transporting.

2.08 Packaged Items

- WELDSKILL 200 AC/DC Inverter Power Source
- Electrode holder with 4m lead
- Work Clamp with 4m lead
- Tig Torch 4m lead with remote current control
- Tig Torch Accessory kit
- Regulator / Flowmeter
- Shielding Gas Hose
- Shoulder Strap
- Operating Manual

WELDSKILL 200AC/DC INVERTER

2.09 Duty Cycle

The rated duty cycle of a Welding Power Source, is a statement of the time it may be operated at its rated welding current output without exceeding the temperature limits of the insulation of the component parts. To explain the 10 minute duty cycle period the following example is used. Suppose a Welding Power Source is designed to operate at a 20% duty cycle, 200 amperes at 18.0 volts. This means that it has been designed and built to provide the rated amperage (200A) for 2 minutes, i.e. arc welding time, out of every 10 minute period (20% of 10 minutes is 2 minutes). During the other 8 minutes of the 10 minute period the Welding Power Source must idle and be allowed to cool. The thermal cut out will operate if the duty cycle is exceeded.

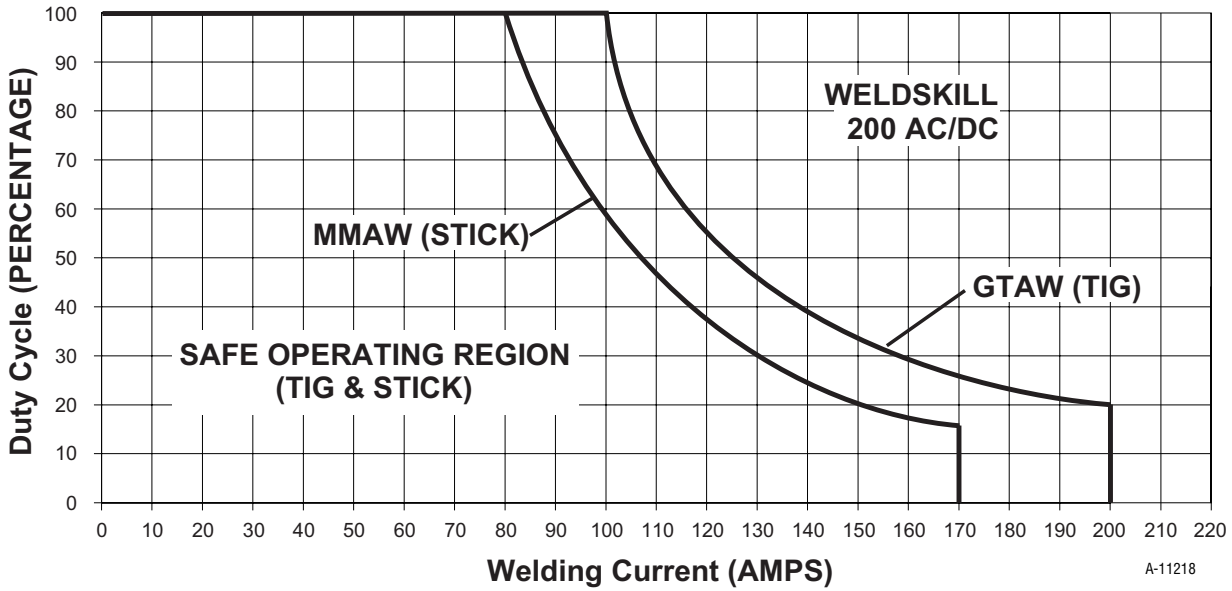


Figure 2-1: WELDSKILL 200AC/DC Duty Cycle

2.10 Specifications

Description	WELDSKILL 200 AC/DC
Plant Part Number	W1006200
Power Source Mass	22 kg
Power Source Dimensions	H 400mm x W 240mm x D 475mm
Cooling	Fan Cooled
Welder Type	Inverter Power Source
Australian Standards	AS 60974.1-2006 / IEC 60974-1
Number of Phases	1
Nominal Supply Voltage	240V +/- 15%
Nominal Supply Frequency	50/60Hz
Welding Current Range (DC STICK Mode)	5 – 170A
Welding Current Range (DC TIG Mode)	5 - 200A
Effective Input Current (I_{1eff}) (note1)	15A
Maximum Input Current (I_{1max})	38.8A
Single Phase Generator Requirement (note2)	10kVA
STICK (MMAW) Welding Output, 40°C, 10 min.	170A @ 15%, 26.8V 100A @ 60%, 24.0V 80A @ 100%, 23.2V
TIG (GTAW) Welding Output, 40°C, 10 min.	200A @ 20%, 18.0V 116A @ 60%, 14.6V 90A @ 100%, 13.6V
Open circuit voltage	72V
Protection Class	IP23S

Table 2-1: WELDSKILL 200AC/DC Specification

NOTE

Note 1: The Effective Input Current should be used for the determination of cable size & supply requirements.

Note 2: Generator Requirements at the Maximum Output Duty Cycle.

Note 3: Motor start fuses or thermal circuit breakers are recommended for this application. Check local requirements for your situation in this regard.

Due to variations that can occur in manufactured products, claimed performance, voltages, ratings, all capacities, measurements, dimensions and weights quoted are approximate only. Achievable capacities and ratings in use and operation will depend upon correct installation, use, applications, maintenance and service.

WELDSKILL 200AC/DC INVERTER

2.11 Options and Accessories

Part Number	Description
W4013602	Tig Torch with 4m lead and remote control
W4015800	Foot Control with 8m lead
BGSAK2	TIG Torch accessory kit

Table 2-2: Options and Accessories

SECTION 3: INSTALLATION, OPERATION AND SETUP

3.01 Environment

These units are designed for use in environments with increased hazard of electric shock as outlined in AS60974.1 and AS1674.2

- A. Examples of environments with increased hazard of electric shock are:
1. In locations in which freedom of movement is restricted, so that the operator is forced to perform the work in a cramped (kneeling, sitting or lying) position with physical contact with conductive parts.
 2. In locations which are fully or partially limited by conductive elements, and in which there is a high risk of unavoidable or accidental contact by the operator.
 3. In wet or damp hot locations where humidity or perspiration considerable reduces the skin resistance of the human body and the insulation properties of accessories.
- B. Environments with increased hazard of electric shock do not include places where electrically conductive parts in the near vicinity of the operator, which can cause increased hazard, have been insulated.

3.02 Location

Be sure to locate the welder according to the following guidelines:

- A. In areas, free from moisture and dust.
- B. Ambient temperature between 0° C to 40° C.
- C. In areas, free from oil, steam and corrosive gases.
- D. In areas, not subjected to abnormal vibration or shock.
- E. In areas, not exposed to direct sunlight or rain.
- F. Place at a distance of 300mm or more from walls or similar that could restrict natural air flow for cooling.
- G. The enclosure design of this power source meets the requirements of IP23S as outlined in AS60529. This provides adequate protection against solid objects (greater than 12mm), and direct protection from vertical drops. Under no circumstances should the unit be operated or connected in a micro environment that will exceed the stated

conditions. For further information please refer to AS 60529.

- H. Precautions must be taken against the power source toppling over. The power source must be located on a suitable horizontal surface in the upright position when in use.

3.03 Ventilation

Since the inhalation of welding fumes can be harmful, ensure that the welding area is effectively ventilated.

3.04 Mains Supply Voltage Requirements

The Mains supply voltage should be within $\pm 15\%$ of the rated mains supply voltage. Too low a voltage may cause poor welding performance. Too high a supply voltage will cause components to overheat and possibly fail.

The Welding Power Source must be:

- Correctly installed, if necessary, by a qualified electrician.
- Correctly earthed (electrically) in accordance with local regulations.
- Connected to the correct size power point and fuse as per the Specifications on page 2-5.



WARNING

Any electrical work must be carried out by a qualified Electrical Tradesperson.

3.05 High Frequency Introduction

The importance of correct installation of high frequency welding equipment cannot be overemphasized. Interference due to high frequency initiated or stabilised arc is almost invariably traced to improper installation. The following information is intended as a guide for personnel installing high frequency welding machines.



WARNING EXPLOSIVES

The high frequency section of this machine has an output similar to a radio transmitter. The machine should NOT be used in the vicinity of blasting operations due to the danger of premature firing



WARNING COMPUTER

It is also possible that operation close to computer installations may cause computer malfunction.

3.06 High Frequency Interference

Interference may be transmitted by a high frequency initiated or stabilised arc welding machine in the following ways.

1. **Direct Radiation:** Radiation from the machine can occur if the case is metal and is not properly grounded. It can occur through apertures such as open access panels. The shielding of the high frequency unit in the Power Source will prevent direct radiation if the equipment is properly grounded.

2. **Transmission via the Supply Lead:** Without adequate shielding and filtering, high frequency energy may be fed to the wiring within the installation (mains) by direct coupling. The energy is then transmitted by both radiation and conduction. Adequate shielding and filtering is provided in the Power Source.

3. **Radiation from Welding Leads:** Radiated interference from welding leads, although pronounced in the vicinity of the leads, diminishes rapidly with distance. Keeping leads as short as possible will minimise this type of interference. Looping and suspending of leads should be avoided wherever possible.

4. **Re-Radiation from Unearthed Metallic Objects:** A major factor contributing to interference is re-radiation from unearthed metallic objects close to the welding leads. Effective grounding of such objects will prevent re-radiation in most cases.

3.07 Electromagnetic Compatibility



WARNING

Extra precautions for Electromagnetic Compatibility may be required when this Welding Power Source is used in a domestic situation.

A. Installation and Use - Users Responsibility

The user is responsible for installing and using the welding equipment according to the manufacturer's instructions. If electromagnetic disturbances are detected then it shall be the responsibility of the user of the welding equipment to resolve the situation with the technical

assistance of the manufacturer. In some cases this remedial action may be as simple as earthing the welding circuit, see NOTE below. In other cases it could involve constructing an electromagnetic screen enclosing the Welding Power Source and the work, complete with associated input filters. In all cases, electromagnetic disturbances shall be reduced to the point where they are no longer troublesome.

NOTE

The welding circuit may or may not be earthed for safety reasons. Changing the earthing arrangements should only be authorised by a person who is competent to assess whether the changes will increase the risk of injury, e.g. by allowing parallel welding current return paths which may damage the earth circuits of other equipment. Further guidance is given in IEC 60974-13 Arc Welding Equipment - Installation and use (under preparation).

B. Assessment of Area

Before installing welding equipment, the user shall make an assessment of potential electromagnetic problems in the surrounding area. The following shall be taken into account

1. Other supply cables, control cables, signalling and telephone cables; above, below and adjacent to the welding equipment.
2. Radio and television transmitters and receivers.
3. Computer and other control equipment.
4. Safety critical equipment, e.g. guarding of industrial equipment.
5. The health of people around, e.g. the use of pacemakers and hearing aids.
6. Equipment used for calibration and measurement.
7. The time of day that welding or other activities are to be carried out.
8. The immunity of other equipment in the environment: the user shall ensure that other equipment being used in the environment is compatible: this may require additional protection measures.

The size of the surrounding area to be considered will depend on the structure of the building and other activities that are taking place. The surrounding area may extend beyond the boundaries of the premises.

C. Methods of Reducing Electromagnetic Emissions**1. Mains Supply**

Welding equipment should be connected to the mains supply according to the manufacturer's recommendations. If interference occurs, it may be necessary to take additional precautions such as filtering of the mains supply. Consideration should be given to shielding the supply cable of permanently installed welding equipment in metallic conduit or equivalent. Shielding should be electrically continuous throughout its length. The shielding should be connected to the Welding Power Source so that good electrical contact is maintained between the conduit and the Welding Power Source enclosure.

2. Maintenance of Welding Equipment

The welding equipment should be routinely maintained according to the manufacturer's recommendations. All access and service doors and covers should be closed and properly fastened when the welding equipment is in operation. The welding equipment should not be modified in any way except for those changes and adjustments covered in the manufacturer's instructions. In particular, the spark gaps of arc striking and stabilising devices should be adjusted and maintained according to the manufacturer's recommendations.

3. Welding Cables

The welding cables should be kept as short as possible and should be positioned close together, running at or close to the floor level.

4. Equipotential Bonding

Bonding of all metallic components in the welding installation and adjacent to it should be considered. However, metallic components bonded to the work piece will increase the risk that the operator could receive a shock by touching the metallic components and the electrode at the same time. The operator should be insulated from all such bonded metallic components.

5. Earthing of the Workpiece

Where the workpiece is not bonded to earth for electrical safety, nor connected to earth because of its size and position, e.g. ship's hull or building steelwork, a connection bonding the workpiece to earth may reduce emissions in some, but not all instances. Care should be taken to prevent the earthing of the workpiece increasing the risk of injury to users, or damage to other electrical equipment. Where necessary, the connection of the workpiece to earth should be made by direct connection to the workpiece, but in some countries where direct connection is not permitted, the bonding should be achieved by suitable capacitance, selected according to national regulations.

6. Screening and Shielding

Selective screening and shielding of other cables and equipment in the surrounding area may alleviate problems of interference. Screening the entire welding installation may be considered for special applications.

WELDSKILL 200AC/DC INVERTER

3.08 WELDSKILL 200AC/DC Power Source Controls, Indicators and Features

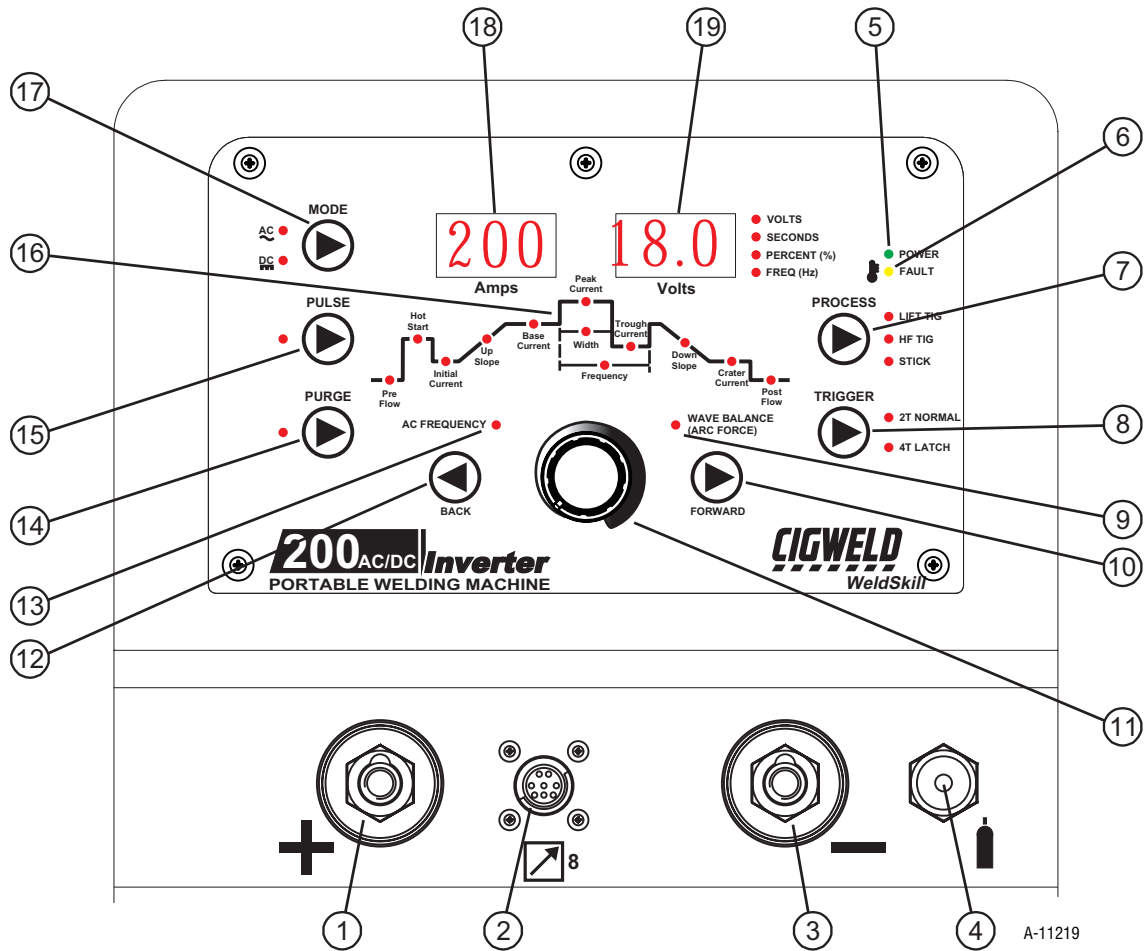


Figure 3-1: Controls on Front Panel

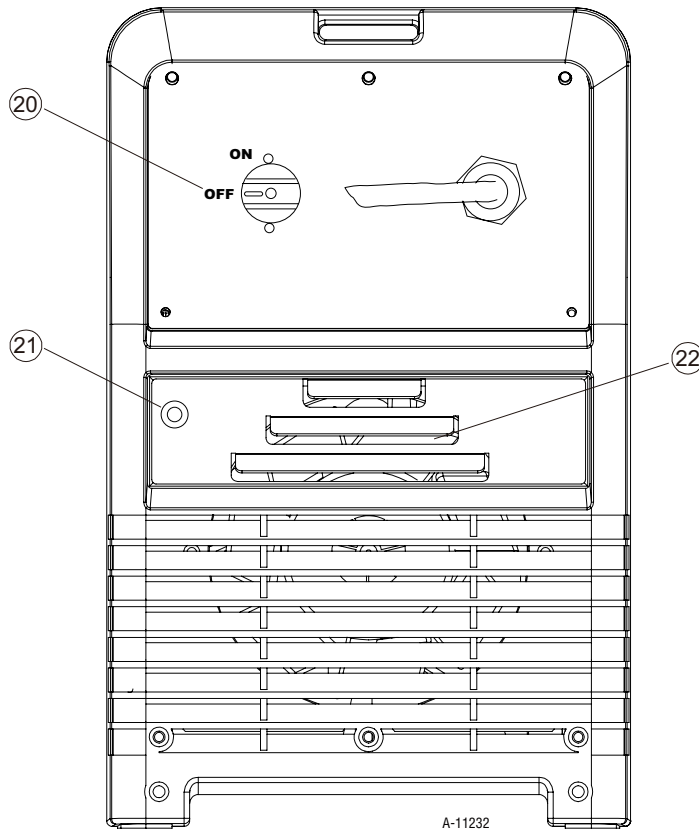


Figure 3-2: Rear Panel

1. Positive Welding Terminal

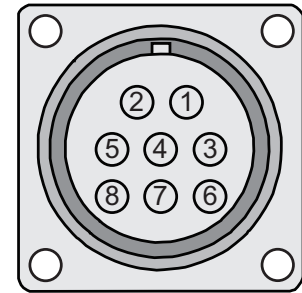
Positive Welding Terminal. Welding current flows from the Power Source via heavy duty bayonet type terminals. It is essential, however, that the male plug is inserted and turned securely to achieve a sound electrical connection.

2. 8 Pin Control Socket

The 8 pin receptacle is used to connect a trigger switch or remote control to the welding Power Source circuitry:

To make connections, align keyway, insert plug, and rotate threaded collar fully clockwise. The socket information is included in the event the supplied cable is not suitable and it is necessary to wire a plug or cable to interface with the 8 pin receptacle.

Socket Pin	Part Number / Description
1	Not used
2	Trigger Switch Input
3	Trigger Switch Input
4	Not used
5	Remote Control 5k ohm Potentiometers Maximum
6	Remote Control 5k ohm Potentiometers Minimum
7	Remote Control 5k ohm Potentiometer Wiper
8	Not used



A-11228

Table 3-1: 8 Pin Interconnection Control Plug Configuration

3. Negative Welding Terminal

Negative Welding Terminal. Welding current flows from the Power Source via heavy duty bayonet type terminals. It is essential, however, that the male plug is inserted and turned securely to achieve a sound electrical connection



CAUTION

Loose welding terminal connections can cause overheating and result in the male plug being fused in the terminal.

4. Shielding Gas Outlet

The Shielding Gas Outlet located on the front panel is a 5/8-18 UNF female gas fitting and is utilised for the connection of a suitable TIG Torch.

5. Power ON Indicator

The POWER ON indicator illuminates when the ON/OFF switch (20) is in the ON position and the correct mains voltage is present.

6. Fault Indicator (Thermal Overload or Primary Circuit Overcurrent)

The Fault Indicator will illuminate in conjunction with an "Err 001" displayed on the ammeter and voltmeter digital displays if either of the following two conditions exists



WELDSKILL 200AC/DC INVERTER

1. Thermal Overload

This is due to the duty cycle of the power source being exceeded. Once the power source cools sufficiently it will automatically reset and the Fault Indicator and Err 001 will go off and the power source is then able to continue welding. During the time of cooling the power source should remain ON such that the fan continues to operate allowing the unit to cool sufficiently. If after 30 minutes with the fan running the Fault Indicator has not gone OFF then have an Accredited CIGWELD Service Provider check the power source.

2. Primary Circuit Overcurrent

This is due to primary circuit component(s) malfunctioning which results in excessive primary circuit current. Switch OFF the power source immediately to allow all components to cool down for at least 30 minutes. If after 30 minutes "Err 001" is displayed and Fault Indicator illuminates when the power source is switched back ON turn the power source OFF and have an Accredited CIGWELD Service Provider check the power source.

7. Process Selection Button

The process selection control is used to select the desired welding mode. Three modes are available, GTAW (LIFT TIG), GTAW (HF TIG) and MMAW (Stick) modes.

Note that when the unit is powered off the mode selection control will automatically default to LIFT TIG mode.

This is necessary so as to prevent inadvertent arcing should an electrode holder be connected to the unit and mistakenly be in contact with the work piece during power up.

8. Trigger Mode Control Button (HF TIG and LIFT TIG Mode only)

The trigger mode control is used to switch the functionality of the torch trigger between 2T (normal), and 4T (latch mode).

2T Normal Mode

In this mode, the torch trigger must remain depressed for the welding output to be active. Press and hold the torch trigger to activate the power source (weld). Release the torch trigger switch to cease welding.

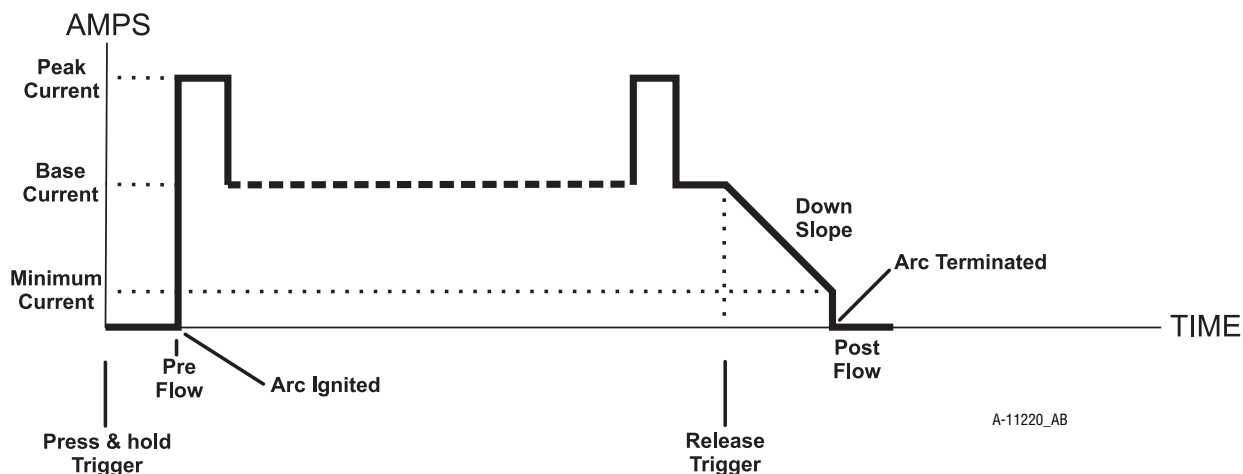


Figure 3-3

4T Latch Mode

This mode of welding is mainly used for long welding runs to reduce operator fatigue. In this mode the operator can press and release the torch trigger and the output will remain active. To deactivate the power source, the trigger switch must again be depressed and realised, thus eliminating the need for the operator to hold the torch trigger.

Note that when operating in GTAW (HF and LIFT TIG modes), the power source will remain activated until the selected down slope time has elapsed

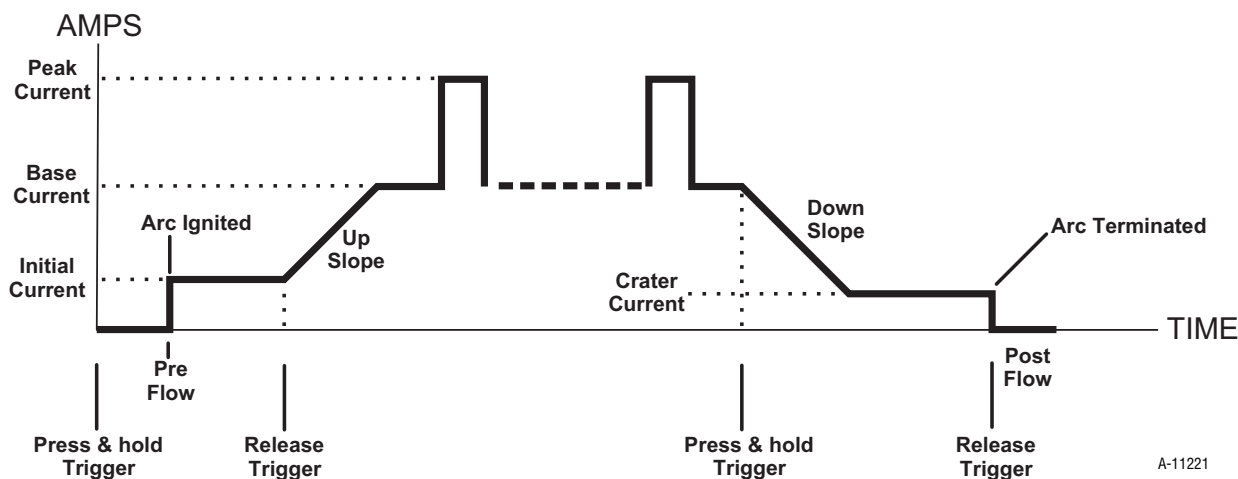


Figure 3-4

9. Wave Balance / Arc Force Indicator

This indicator light will illuminate when programming Wave Balance (AC HF TIG mode only) or Arc Force (STICK mode only).

10. Forward Programming Button

Pressing this button will advance to the next step in the programming sequence.

11. Multifunction Control

The multifunction control knob is used to adjust welding current.

It is also used to adjust parameters when in programming mode.

12. Back Programming Button

Pressing this button will go back to the previous step in the programming sequence.

13. AC frequency Indicator

This indicator light will illuminate when programming AC Frequency (AC HF TIG mode only).

14. Purge Button

Press and hold the PURGE button to purge the gas line in LIFT TIG and HF TIG modes. To PURGE the shielding gas line in LIFT TIG and HF TIG modes press the PURGE button and release. The indicator will illuminate and shielding gas will purge for a preset period of 15 seconds. (This cannot be adjusted). To stop shielding gas from purging within this time press the PURGE button and release and the purge indicator will extinguish and shielding gas will cease.

15 Pulse Button

Press the PULSE button to toggle Pulse On and OFF in LIFT TIG and HF TIG modes

16. Programming Parameter Indicators

These indicator lights will illuminate when programming.

17. Mode Button

Press the MODE button to toggle AC and DC output in all Process modes

18. Digital Ammeter

The digital amperage meter is used to display both the pre-set current and actual output current of the power source.

WELDSKILL 200AC/DC INVERTER

At times of non-welding, the amperage meter will display a pre-set (preview) amperage value. This value can be adjusted by varying the multifunction control when the Programming Parameter Indicator light shows BASE CURRENT.

When welding, the amperage meter will display actual welding current.

Should a remote device be connected the maximum setting of the power source will be determined by the respective front panel control, irrespective of the remote control device setting. As an example, if the output current on the power source front panel is set to 50% and the remote control device is set to 100%, the maximum achievable output from the unit will be 50%. Should 100% output be required, the respective power source front panel control must be set to 100%, in which case the remote device will then be able to control between 0-100% output.

NOTE

If a fault condition occurs for either Thermal Overload or Primary Circuit Overload then "Err" is displayed on this meter. (Refer to section 3.08.6 Fault Indicator for further detail)

19. Digital Voltmeter / Parameter meter

The digital volt meter is used to display the actual output voltage of the power source. It is also used to display Parameters in Programming Mode.

Depending on the Programming Parameter selected, the status indicator adjacent to the volt meter will illuminate to show the units of the programming parameter.

When welding, the volt meter will display actual welding voltage.

NOTE

If a fault condition occurs for either Thermal Overload or Primary Circuit Overload then an "001" is displayed on this meter. (Refer to section 3.08.6 Fault Indicator for further detail)

20. On / Off Switch

This Switch is located on the rear of the Power Source and turns mains power off and on.



When the front digital displays are lit, the machine is connected to the Mains supply voltage and the internal electrical components are at Mains voltage potential

21. Shielding Gas Inlet

The Shielding Gas Inlet is a 5mm nipple suitable for connection of a gas hose to a regulated Shielding Gas Supply. The Shielding Gas inlet is located on the rear of the Power Source.

22. Cooling Fan

The WeldSkill 200AC/DC is fitted with a cooling fan that will operate continuously when the On/Off switch on the rear panel is switched to the On position.

3.09 WELDSKILL 200AC/DC - STICK Programming Mode

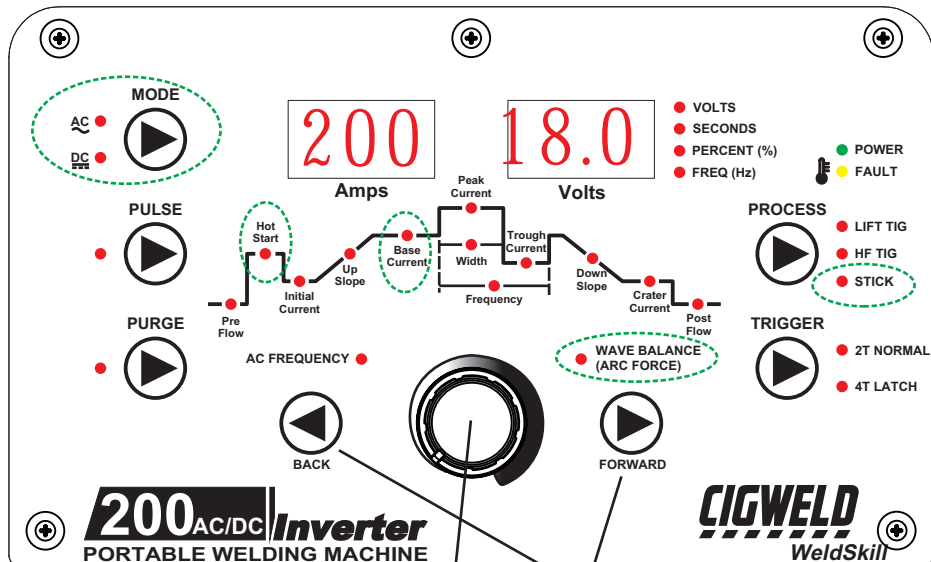
Press the PROCESS button to select STICK mode.

Press the MODE switch to toggle between AC and DC welding output.

The Programming LED's are always active. Press FORWARD or BACK to cycle through available programming functions.

Use the Multi Function Control to adjust the Parameter selected.

While welding the Multi Function Control directly controls the BASE CURRENT



Adjust programming parameter

Press to go forward / go back between programming status LED's

A-11222

Figure 3-5: Stick Programming Mode

Programming Parameter	Adjustment Device	Display
<p>Hot Start</p> <p>This parameter operates in all weld modes except LIFT TIG mode and is used to heat up the weld zone in TIG modes or improve the start characteristics for stick electrodes the peak start current on top of the BASE (WELD) current. e.g. HOT START current = 130 amps when BASE (WELD) = 100 amps & HOT START = 30 amps</p>		<p>70</p> <p>Amps</p> <p>0 to 70A (max 170A weld current)</p>
<p>Base Current</p> <p>This parameter sets the TIG WELD current when PULSE is OFF. This parameter also sets the STICK weld current.</p>		<p>170</p> <p>Amps</p> <p>5 to 170A (DC STICK mode) 10 to 170A (AC STICK mode)</p>
<p>Arc Force (STICK Mode only)</p> <p>Arc Force is effective when in Manual Arc Mode only. Arc Force control provides and adjustable amount of Arc Force (or "dig") control. This feature can be particularly beneficial in providing the operator the ability to compensate for variability in joint fit-up in certain situations with particular electrodes. In general increasing the Arc Force control toward 100% (maximum Arc Force) allows greater penetration control to be achieved.</p>		<p>100</p> <p>Volts</p> <p>0 to 100%</p> <p>Legend: ● VOLTS ● SECONDS ● PERCENT (%) ● FREQ (Hz)</p>

Table 3-2

WELDSKILL 200AC/DC INVERTER

3.10 WELDSKILL 200AC/DC – LIFT TIG and HF TIG Programming Mode

Press the PROCESS button to select LIFT TIG or HF TIG mode.

Press the MODE switch to goggle between AC and DC welding output.

The Programming LED's are always active. Press FORWARD or BACK to cycle through available programming functions.

Use the Multi Function Control to adjust the parameter selected.

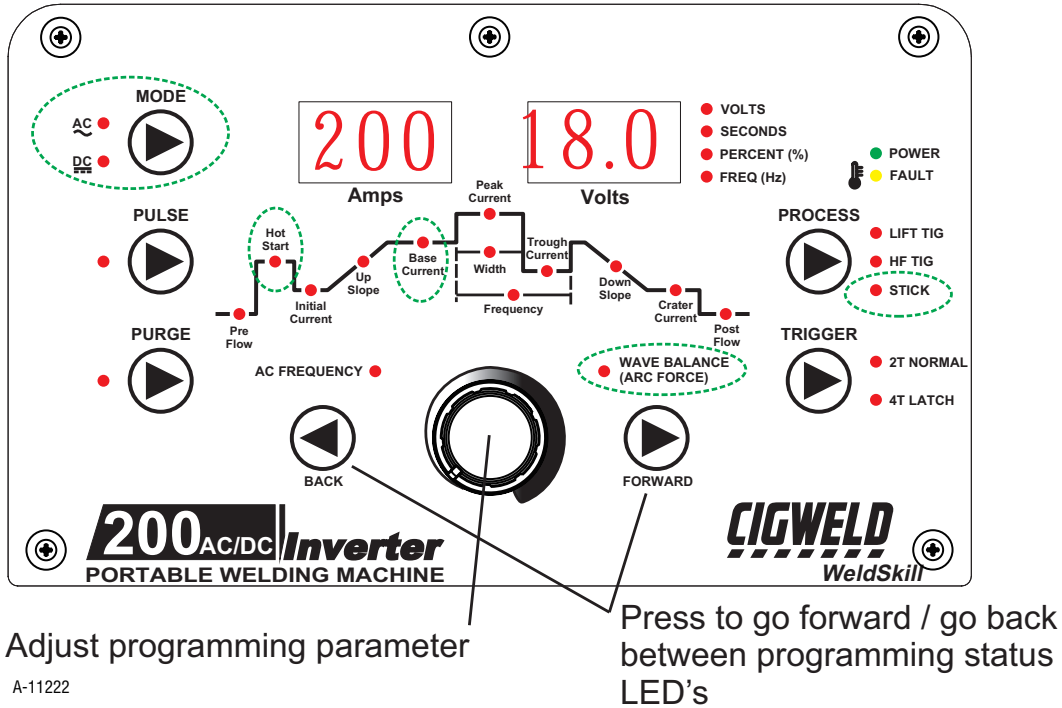










Figure 3-6: LIFT TIG and HF TIG Programming Mode

Programming Parameter	Adjustment Device	Display
<p>Pre-Flow</p> <p>This parameter operates in TIG modes only and is used to provide gas to the weld zone prior to striking the arc, once the torch trigger switch has been pressed. This control is used to dramatically reduce weld porosity at the start of a weld.</p>		<p>Volts 0.0 to 1.0 second</p>
<p>Initial Current</p> <p>This parameter operates in (4T) TIG modes only and is used to set the start current for TIG. The Start Current remains on until the torch trigger switch is released after it has been depressed. Note: The maximum initial current available will be limited to the set value of the base current.</p>		<p>Amps 5 to 200 Amps (DC TIG mode) 30 to 200 Amps (AC LIFT TIG mode) 10 to 200A (AC HF TIG mode)</p>

<p>Up Slope</p> <p>This parameter operates in (4T) TIG modes only and is used to set the time for the weld current to ramp up, after the torch trigger switch has been pressed then released, from INITIAL CUR to PEAK or BASE current.</p>		<div style="display: flex; align-items: center;"> <div style="border: 1px solid black; padding: 5px; margin-right: 10px;">15.0</div> <div style="font-size: 0.8em;"> <ul style="list-style-type: none"> ● VOLTS ● SECONDS ● PERCENT (%) ● FREQ (Hz) </div> </div> <p>Volts 0.0 to 15.0 seconds</p>
<p>Base Current</p> <p>This parameter sets the TIG WELD current when PULSE is OFF. This parameter also sets the STICK weld current.</p>		<div style="display: flex; align-items: center;"> <div style="border: 1px solid black; padding: 5px; margin-right: 10px;">200</div> </div> <p>Amps 5 to 200A (DC TIG mode) 30 to 200A (AC LIFT TIG mode) 10 to 200A (AC HF TIG mode)</p>
<p>Peak Current</p> <p>This parameter sets the PEAK weld current when in PULSE mode.</p>		<div style="display: flex; align-items: center;"> <div style="border: 1px solid black; padding: 5px; margin-right: 10px;">200</div> </div> <p>Amps 10 to 200A (DC TIG mode) 30 to 200A (AC TIG mode)</p>
<p>Trough Current</p> <p>The lowest point in the pulse is called the Trough.</p>		<div style="display: flex; align-items: center;"> <div style="border: 1px solid black; padding: 5px; margin-right: 10px;">200</div> </div> <p>Amps 5 to 200A (DC HF TIG mode) 30 to 200A (AC LIFT TIG mode) 10 to 200A (AC HF TIG mode)</p>
<p>Pulse Width</p> <p>This parameter sets the percentage on time of the PULSE FREQUENCY for PEAK weld current when the PULSE is ON.</p>		<div style="display: flex; align-items: center;"> <div style="border: 1px solid black; padding: 5px; margin-right: 10px;">80</div> <div style="font-size: 0.8em;"> <ul style="list-style-type: none"> ● VOLTS ● SECONDS ● PERCENT (%) ● FREQ (Hz) </div> </div> <p>Volts 15 to 80%</p>
<p>Pulse Frequency</p> <p>This parameter sets the PULSE FREQUENCY when the PULSE is ON..</p>		<div style="display: flex; align-items: center;"> <div style="border: 1px solid black; padding: 5px; margin-right: 10px;">200</div> <div style="font-size: 0.8em;"> <ul style="list-style-type: none"> ● VOLTS ● SECONDS ● PERCENT (%) ● FREQ (Hz) </div> </div> <p>Volts 0.5 to 200 Hz</p>
<p>Down Slope</p> <p>This parameter operates in TIG modes only and is used to set the time for the weld current to ramp down, after the torch trigger switch has been pressed, to crater current. This control is used to eliminate the crater that can form at the completion of a weld.</p>		<div style="display: flex; align-items: center;"> <div style="border: 1px solid black; padding: 5px; margin-right: 10px;">25.0</div> <div style="font-size: 0.8em;"> <ul style="list-style-type: none"> ● VOLTS ● SECONDS ● PERCENT (%) ● FREQ (Hz) </div> </div> <p>Volts 0.0 to 25.0 seconds</p>
<p>Crater Current</p> <p>This parameter operates in (4T) TIG modes only and is used to set the finish current for TIG. The CRATER Current remains ON until the torch trigger switch is released after it has been depressed. Note: The maximum crater current available will be limited to the set value of the base current.</p>		<div style="display: flex; align-items: center;"> <div style="border: 1px solid black; padding: 5px; margin-right: 10px;">200</div> <div style="font-size: 0.8em;"> <ul style="list-style-type: none"> ● VOLTS ● SECONDS ● PERCENT (%) ● FREQ (Hz) </div> </div> <p>Amps 5 to 200A (DC TIG mode) 30 to 200A (AC TIG mode) 10 to 200A (AC HF TIG mode)</p>

WELDSKILL 200AC/DC INVERTER




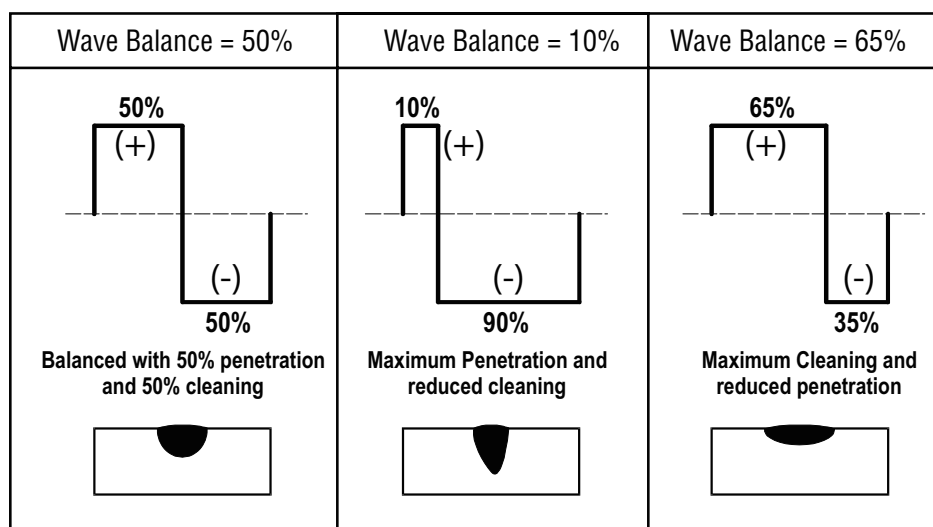
<p>Post Flow</p> <p>This parameter operates in TIG modes only and is used to adjust the post gas flow time once the arc has extinguished. This control is used to dramatically reduce oxidation of the tungsten electrode.</p>		<p>60.0</p> <p>Volts 0.0 to 60.0 seconds</p> <ul style="list-style-type: none"> ● VOLTS ● SECONDS ● PERCENT (%) ● FREQ (Hz)
<p>AC Frequency</p> <p>This parameter operates in AC TIG mode only and is used to set the frequency for the AC weld current.</p>		<p>150</p> <p>Volts 15 to 150 Hz</p> <ul style="list-style-type: none"> ● VOLTS ● SECONDS ● PERCENT (%) ● FREQ (Hz)
<p>Wave Balance</p> <p>This parameter operates in AC TIG mode and is used to set the penetration to cleaning action ratio for the AC weld current. Generally WAVE BALANCE is set to 50% for AC STICK welding. The WAVE BALANCE control changes the ratio of penetration to cleaning action of the AC TIG welding arc. Maximum weld penetration is achieved when the WAVE BALANCE control is set to 10%. Maximum cleaning of heavily oxidised aluminium or magnesium alloys is achieved when the WAVE BALANCE control is set to 65%.</p>		<p>65</p> <p>Volts 10 to 65%</p> <ul style="list-style-type: none"> ● VOLTS ● SECONDS ● PERCENT (%) ● FREQ (Hz)

Table 3-3

WAVE BALANCE is used for aluminium welding in AC HF TIG or AC LIFT TIG mode

It is used to set the ratio of penetration to cleaning action for the AC TIG welding arc.

Maximum weld penetration is achieved when the WAVE BALANCE is set to 10%. Maximum cleaning of heavily oxidised aluminium or magnesium alloys is achieved when the WAVE BALANCE is set to 65%.



A-11223

Table 3-4: AC TIG Wave Balance

3.11 Short Circuit Protection While Welding

To prolong the useful life of a TIG tungsten electrode, the WeldSkill 200 AC/DC incorporates special circuitry. In DC LIFT TIG mode, if the tungsten electrode touches the work the welding current is reduced to 40 Amps. In DC HF TIG mode, if the tungsten electrode touches the work the welding current is reduced to 30 Amps within 1 second.

In STICK mode, if the electrode touches the work for more than two seconds the welding current is reduced to 0 Amps.

3.12 Shielding Gas Regulator Operating Instructions



This equipment is designed for use with welding grade (Inert) shielding gases only.

Shielding Gas Regulator Safety

This regulator is designed to reduce and control high pressure gas from a cylinder or pipeline to the working pressure required for the equipment using it.

If the equipment is improperly used, hazardous conditions are created that may cause accidents. It is the users responsibility to prevent such conditions. Before handling or using the equipment, understand and comply at all times with the safe practices prescribed in this instruction.

SPECIFIC PROCEDURES for the use of regulators are listed below.

1. NEVER subject the regulator to inlet pressure greater than its rated inlet pressure.
2. NEVER pressurize a regulator that has loose or damaged parts or is in a questionable condition. NEVER loosen a connection or attempt to remove any part of a regulator until the gas pressure has been relieved. Under pressure, gas can dangerously propel a loose part.
3. DO NOT remove the regulator from a cylinder without first closing the cylinder valve and releasing gas in the regulator high and low pressure chambers.
4. DO NOT use the regulator as a control valve. When downstream equipment is not in use for extended periods of time, shut off the gas at the cylinder valve and release the gas from the equipment.
5. OPEN the cylinder valve SLOWLY. Close after use.

User Responsibilities

This equipment will perform safely and reliable only when installed, operated and maintained, and repaired in accordance with the instructions provided. Equipment must be checked periodically and repaired, replaced, or reset as necessary for continued safe and reliable performance. Defective equipment should not be used. Parts that are broken, missing, obviously worn, distorted, or contaminated should be replaced immediately.

The user of this equipment will generally have the sole responsibility for any malfunction, which results from improper use, faulty maintenance, or by repair by anyone other than an accredited repairer.



Match regulator to cylinder. NEVER CONNECT a regulator designed for a particular gas or gases to a cylinder containing any other gas.

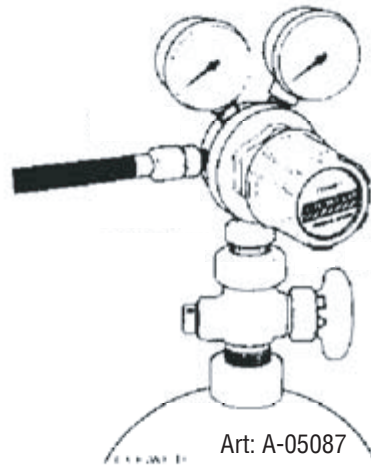


Figure 3-7: Fit Regulator to Cylinder

Installation

1. Remove cylinder valve plastic dust seal. Clean the cylinder valve outlet of impurities that may clog orifices and damage seats before connecting the regulator.

Crack the valve (open then close) momentarily, pointing the outlet away from people and sources of ignition. Wipe with a clean lint free cloth.

2. Match regulator to cylinder. Before connecting, check that the regulator label and cylinder marking agree and that the regulator inlet and cylinder outlet match. NEVER CONNECT a regulator designed for a particular gas or gases to a cylinder containing any other gas.
3. Connect the regulator inlet connection to cylinder or pipeline and tighten it firmly but not excessively, with a suitable spanner.
4. Connect and tighten the outlet hose firmly and attach down-stream equipment.
5. To protect sensitive down-stream equipment a separate safety device may be necessary if the regulator is not fitted with a pressure relief device.

Operation

With the regulator connected to cylinder or pipeline, and the adjustment screw/knob fully disengaged, pressurize as follows:

1. Stand to one side of regulator and slowly open the cylinder valve. If opened quickly, a sudden pressure surge may damage internal regulator parts.
2. With valves on downstream equipment closed, adjust regulator to approximate working pressure. It is recommended that testing for leaks at the regulator connection points be carried out using a suitable leak detection solution or soapy water.
3. Purge air or other unwanted welding grade shielding gas from equipment connected to the regulator by individually opening then closing the equipment control valves. Complete purging may take up to ten seconds or more, depending upon the length and size of the hose being purged.

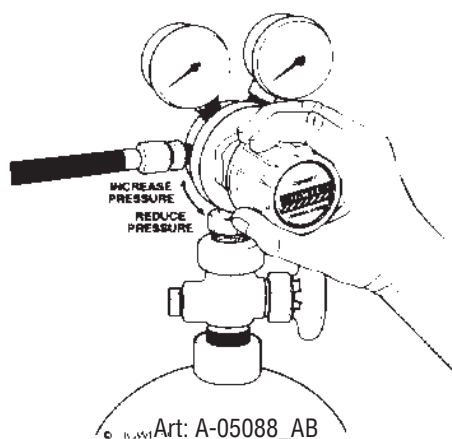
Adjusting Flow Rate

Figure 3-8: Adjust Flow Rate

With the regulator ready for operation, adjust working flow rate as follows:

1. Slowly turn adjusting screw/knob in (clockwise) direction until the outlet gauge indicates the required flow rate.

NOTE

It may be necessary to re-check the shielding gas regulator flow rate following the first weld sequence due to back pressure present within shielding gas hose assembly.

2. To reduce flow rate, allow the welding grade shielding gas to discharge from regulator by opening the downstream valve. Bleed welding grade shielding gas into a well ventilated area and away from any ignition source. Turn adjusting screw counter clockwise, until the required flow rate is indicated on the gauge. Close downstream valve.

Shutdown

Close cylinder valve whenever the regulator is not in use. To shut down for extended periods (more than 30 minutes).

1. Close cylinder or upstream valve tightly.
2. Open downstream equipment valves to drain the lines. Bleed gas into a well ventilated area and away from any ignition source.
3. After gas is drained completely, disengage adjusting screw and close downstream equipment valves.
4. Before transporting cylinders that are not secured on a cart designed for such purposes, remove regulators.

3.13 Setup for TIG (GTAW) Welding

- A. Select Lift TIG or HF TIG mode with the process selection control (refer to Section 3.08.7 for further information).
- B. Connect the TIG Torch to the negative welding terminal (-). Welding current flows from the power source via heavy duty bayonet type terminals. It is essential, however, that the male plug is inserted and turned securely to achieve a sound electrical connection.
- C. Connect the work lead to the positive welding terminal (+). Welding current flows from the Power Source via heavy duty bayonet type terminals. It is essential, however, that the male plug is inserted and turned securely to achieve a sound electrical connection.

WELDSKILL 200AC/DC INVERTER



CAUTION

Loose welding terminal connections can cause overheating and result in the male plug being fused in the bayonet terminal.

- D. Connect the TIG torch trigger switch via the 8 pin socket located on the front of the power source as shown below. The TIG torch will require a trigger switch to operate in Lift TIG or HF TIG Mode.

NOTE

If the TIG torch has a remote TIG torch current control fitted then it will require to be connected to the 8 pin socket. (Refer to section 3.08.2 Remote Control Socket for further information).

- E. Fit the welding grade shielding gas regulator/flowmeter to the shielding gas cylinder (refer to Section 3.12) then connect the shielding gas hose from the regulator/flowmeter outlet gas INLET on the rear of the WeldSkill 200 AC/DC Power Source. Connect the gas hose from the TIG torch to the gas OUTLET on the front of the WeldSkill 200 AC/DC Power Source.



WARNING

Before connecting the work clamp to the work make sure the mains power supply is switched off.

Secure the welding grade shielding gas cylinder in an upright position by chaining it to a suitable stationary support to prevent falling or tipping.

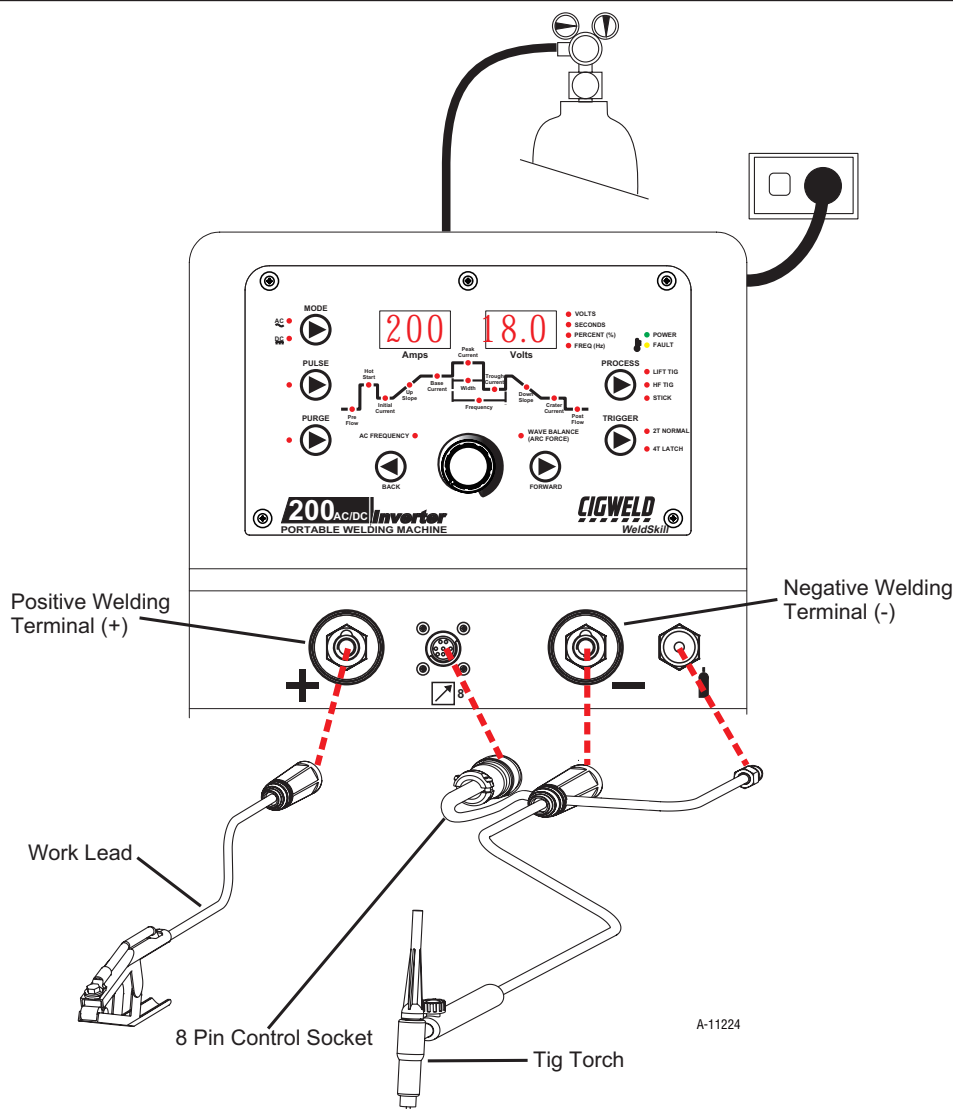


Figure 3-9: Setup for TIG Welding

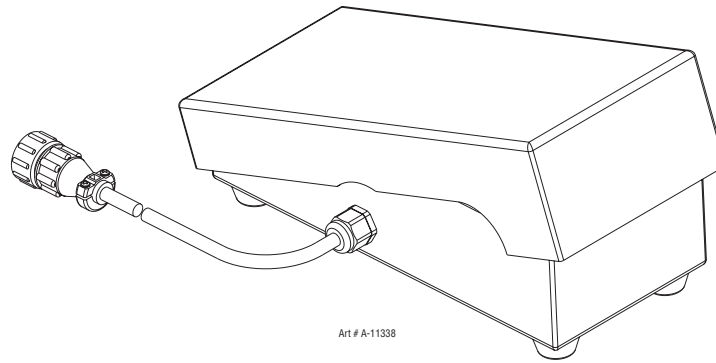
3.14 Foot Control, Part No. W4015800 (Optional Accessory)

Figure 3-10: Foot Control

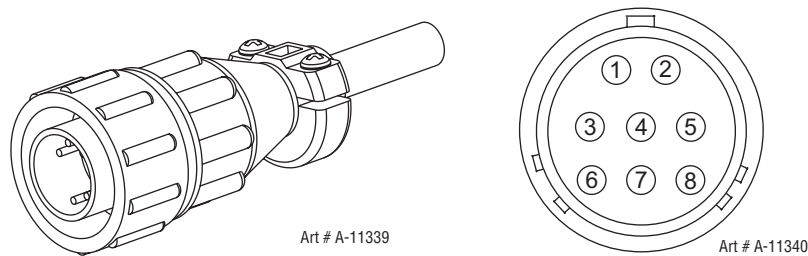


Figure 3-11: 8 Pin Control Plug

Pin	Description
1	Not Used
2	Trigger Switch
3	Trigger Switch
4	Not Used
5	Potentiometer Maximum
6	Potentiometer Minimum
7	Potentiometer Wiper
8	Not Used

Table 3-4

Description

The CIGWELD Foot Control is a foot operated switch and potentiometer which starts and stops the welding process and controls welding current through operation of the foot pedal. Refer to list below for compatible Cigweld power sources.

Installation

Attach the 8-pin connector on the end of the cable to the 8-pin receptacle on the front of the welding machine. To complete the connection, align the keyway, insert the plug, and rotate the threaded collar fully clockwise.

WELDSKILL 200AC/DC INVERTER

Foot Control Operation

Press the foot pedal to start the machine output functions. The foot control potentiometer controls the welding current up to the level set on the welding power source. Note that the maximum current must be set on the power source by the operator **prior** to the foot control being connected. With the foot control connected, the power source will only display minimum preview Amps until the foot control is depressed then it displays actual welding current when welding. Pressing the pedal to increases the welding current; letting up on the pedal decreases the welding current. Releasing the pedal completely extinguishes the arc and initiates the post-flow shielding gas timer (where fitted).

Note that some power sources may require the remote/local switch set to remote, the maximum setting of the power source will be determined by the respective front panel control, irrespective of the remote control device setting. As an example, if the output current on the power source front panel is set to 50% of the available current and the remote control device is set to 100% output or maximum, the maximum achievable output from the unit will be 50%. Should 100% output be required, the respective front panel control must be set to 100% or maximum, in which case the remote device will then be able to control between 1-100% output.

This foot control is compatible with the following Cigweld power sources:

WeldSkill 200AC/DC Part No: W1006202

Transmig 175i Part No: W1005176

Transmig 200i Part No: W1005202

Transmig 250i Part No: W1003251

Transtig 200AC/DC Part No: 700719

Note 1: Some power sources other than specified as above may not function with the foot control.

Note 2: The foot control will only work correctly when power source trigger mode 2T (Normal) is selected.

3.15 Setup for STICK (MMAW) Welding

- A. Connect the Electrode Holder lead to the positive welding terminal (+). If in doubt, consult the electrode manufacturer. Welding current flows from the Power Source via heavy duty bayonet type terminals. It is essential, however, that the male plug is inserted and turned securely to achieve a sound electrical connection.
- B. Connect the work lead to the negative welding terminal (-). If in doubt, consult the electrode manufacturer. Welding current flows from the power source via heavy duty bayonet type terminals. It is essential, however, that the male plug is inserted and turned securely to achieve a sound electrical connection.
- C. Select STICK mode with the process selection control (refer to Section 3.08.7 for further information)



WARNING

Before connecting the work clamp to the work and inserting the electrode in the electrode holder make sure the mains power supply is switched off.



CAUTION

Remove any packaging material prior to use. Do not block the air vents at the front or rear of the Welding Power Source.



CAUTION

Loose welding terminal connections can cause overheating and result in the male plug being fused in the bayonet terminal.

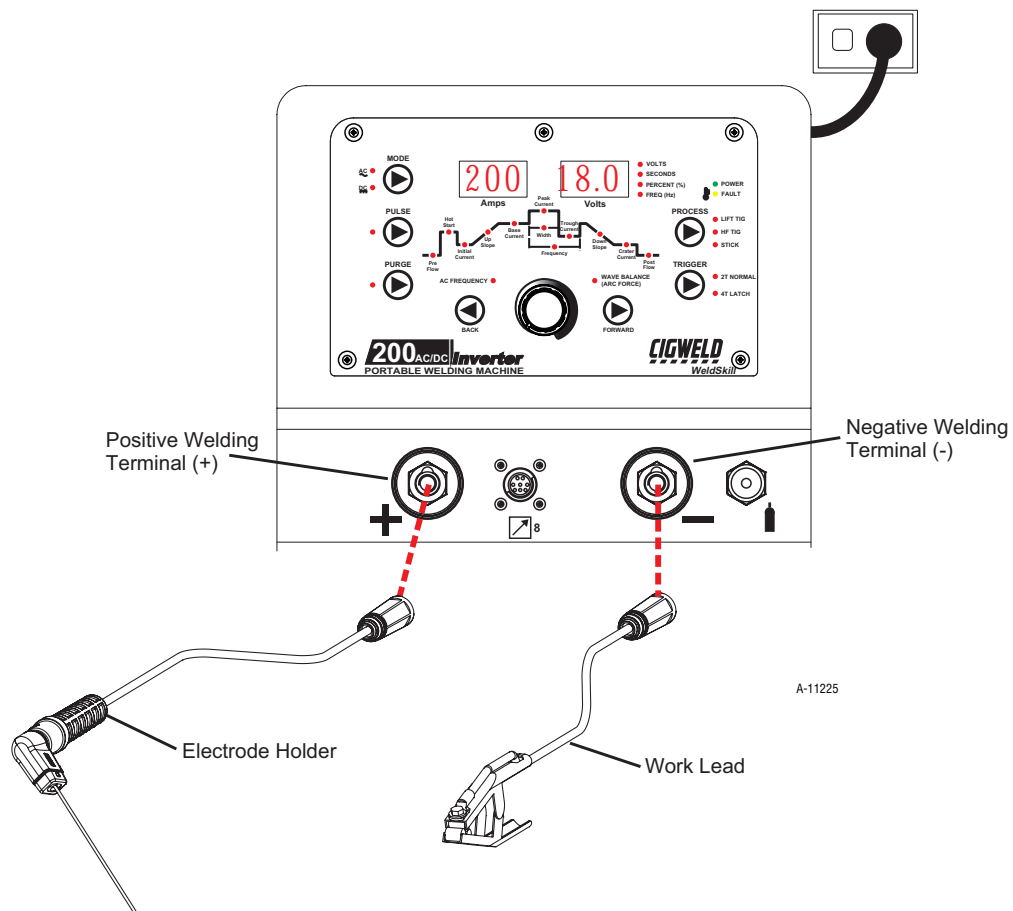


Figure 3-12: Setup for Manual Arc Welding.

This page is left blank intentionally.

SECTION 4: BASIC WELDING GUIDE

4.01 Stick (MMAW) Basic Welding Technique

Size of Electrode

The electrode size is determined by the thickness of metals being joined and can also be governed by the type of welding machine available. Small welding machines will only provide sufficient current (amperage) to run the smaller size electrodes.

For thin sections, it is necessary to use smaller electrodes otherwise the arc may burn holes through the job. A little practice will soon establish the most suitable electrode for a given application.

Storage of Electrodes

Always store electrodes in a dry place and in their original containers.

Electrode Polarity

Electrodes are generally connected to the ELECTRODE HOLDER with the Electrode Holder connected positive polarity. The WORK LEAD is connected negative polarity and is connected to the work piece. If in doubt consult the electrode data sheet or your nearest Accredited CIGWELD Distributor.

Effects of Arc Welding Various Materials

A. High tensile and alloy steels

The two most prominent effects of welding these steels are the formation of a hardened zone in the weld area, and, if suitable precautions are not taken, the occurrence in this zone of under-bead cracks may result. Hardened zone and under-bead cracks in the weld area may be reduced by using the correct electrodes, preheating, using higher current settings, using larger electrode sizes, short runs for larger electrode deposits or tempering in a furnace.

Hydrogen controlled Electrodes must be used for this application. Use Ferrocraft 61 or 16TXP for normal strength (500 MPa) steels, and Alloycraft range for higher strength steels.

B. Austenitic manganese steels

The effect on manganese steel of slow cooling from high temperatures is to embrittle it. For this reason it is absolutely essential to keep manganese steel cool during welding by quenching after each weld or skip welding to distribute the heat. Suitable Electrode types are Cobalarc Austex or Cobalarc Mangcraft.

C. Cast Iron

Most types of cast iron, except white iron, are weldable. White iron, because of its extreme brittleness, generally cracks when attempts are made to weld it. Trouble may also be experienced when welding white-heart malleable, due to the porosity caused by gas held in this type of iron. Suitable Electrode types are Castcraft 55 or Castcraft 100.

D. Copper and alloys

The most important factor is the high rate of heat conductivity of copper, making preheating of heavy sections necessary to give proper fusion of weld and base metal. Suitable Electrode types are Bronzecraft AC-DC electrodes.

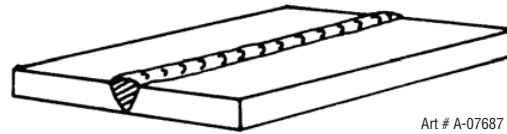
Arc Welding Practice

The techniques used for arc welding are almost identical regardless of what types of metals are being joined. Naturally enough, different types of electrodes would be used for different metals as described in the preceding section.

WELDSKILL 200AC/DC INVERTER

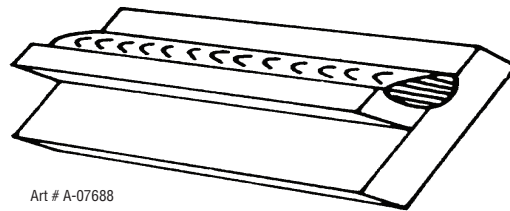
Welding Position

The electrodes dealt with in this publication can be used in most positions, i.e. they are suitable for welding in flat, horizontal, vertical and overhead positions. Numerous applications call for welds to be made in positions intermediate between these. Some of the common types of welds are shown in Figures 4-5 through 4-12.



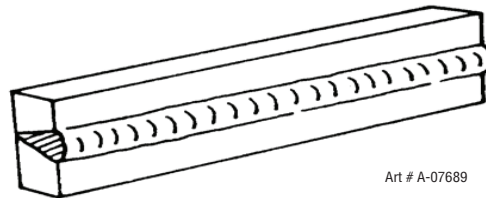
Art # A-07687

Figure 4-1: Flat Position, Down Hand Butt Weld



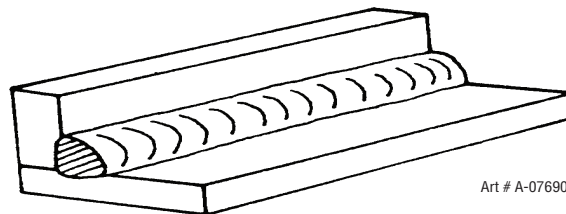
Art # A-07688

Figure 4-2: Flat Position, Gravity Fillet Weld



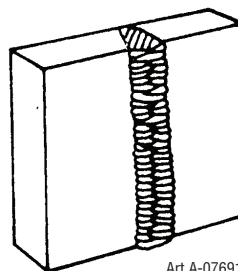
Art # A-07689

Figure 4-3: Horizontal Position, Butt Weld



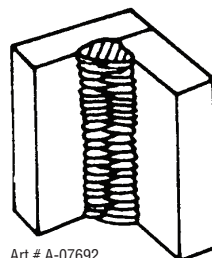
Art # A-07690

Figure 4-4: Horizontal-Vertical (HV) Position



Art A-07691

Figure 4-5: Vertical Position, Butt Weld



Art # A-07692

Figure 4-6: Vertical Position, Fillet Weld

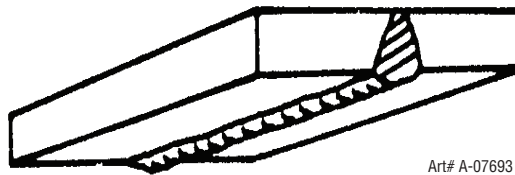


Figure 4-7: Overhead Position, Butt Weld

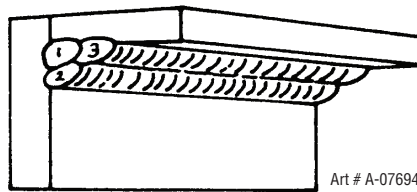


Figure 4-8: Overhead Position, Fillet Weld

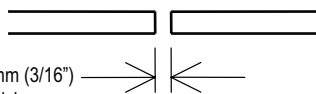
Joint Preparations

In many cases, it will be possible to weld steel sections without any special preparation. For heavier sections and for repair work on castings, etc., it will be necessary to cut or grind an angle between the pieces being joined to ensure proper penetration of the weld metal and to produce sound joints.

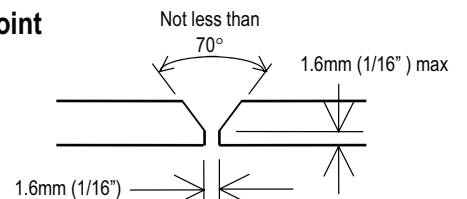
In general, surfaces being welded should be clean and free of rust, scale, dirt, grease, etc. Slag should be removed from oxy-cut surfaces. Typical joint designs are shown in Figure 4-9.

Open Square Butt Joint

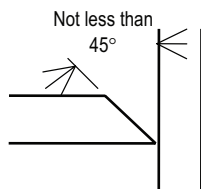
Gap varies from 1.6mm (1/16") to 4.8mm (3/16") depending on plate thickness



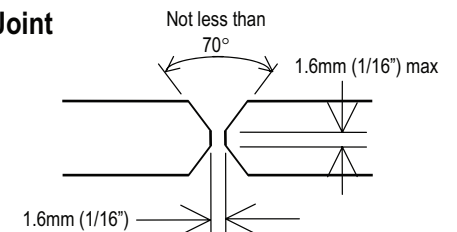
Single Vee Butt Joint



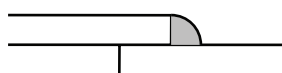
Single Vee Butt Joint



Double Vee Butt Joint



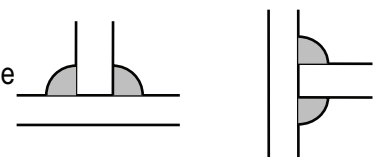
Lap Joint



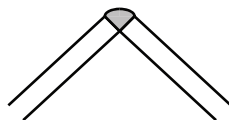
Fillet Joint



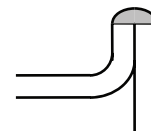
Tee Joints
(Fillet both sides of the joint)



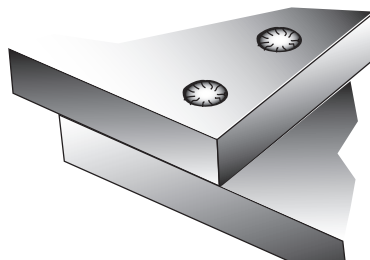
Corner Weld



Edge Joint



Plug Weld



Plug Weld

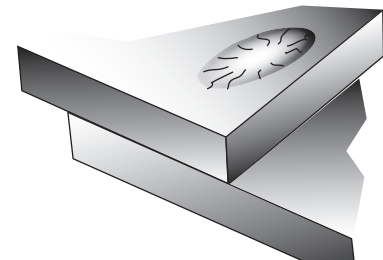


Figure 4-9: Typical Joint Designs for Arc Welding

WELDSKILL 200AC/DC INVERTER

Arc Welding Technique - A Word to Beginners

For those who have not yet done any welding, the simplest way to commence is to run beads on a piece of scrap plate. Use mild steel plate about 6.0mm thick and a 3.2mm electrode. Clean any paint, loose scale or grease off the plate and set it firmly on the work bench so that welding can be carried out in the downhand position. Make sure that the work clamp is making good electrical contact with the work, either directly or through the work table. For light gauge material, always clamp the work lead directly to the job, otherwise a poor circuit will probably result.

The Welder

Place yourself in a comfortable position before beginning to weld. Get a seat of suitable height and do as much work as possible sitting down. Don't hold your body tense. A taut attitude of mind and a tensed body will soon make you feel tired. Relax and you will find that the job becomes much easier. You can add much to your peace of mind by wearing a leather apron and gauntlets. You won't be worrying then about being burnt or sparks setting alight to your clothes.

Place the work so that the direction of welding is across, rather than to or from, your body. The electrode holder lead should be clear of any obstruction so that you can move your arm freely along as the electrode burns down. If the lead is slung over your shoulder, it allows greater freedom of movement and takes a lot of weight off your hand. Be sure the insulation on your cable and electrode holder is not faulty, otherwise you are risking an electric shock.

Striking the Arc

Practice this on a piece of scrap plate before going on to more exacting work. You may at first experience difficulty due to the tip of the electrode "sticking" to the work piece. This is caused by making too heavy a contact with the work and failing to withdraw the electrode quickly enough. A low amperage will accentuate it. This freezing-on of the tip may be overcome by scratching the electrode along the plate surface in the same way as a match is struck. As soon as the arc is established, maintain a 1.6mm to 3.2mm gap between the burning electrode end and the parent metal. Draw the electrode slowly along as it melts down.

Another difficulty you may meet is the tendency, after the arc is struck, to withdraw the electrode so far that the arc is broken again. A little practice will soon remedy both of these faults.

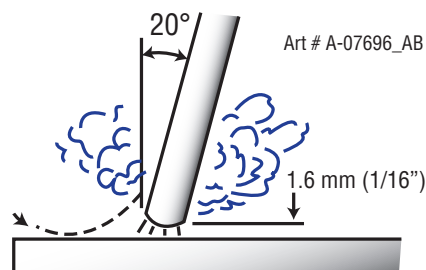


Figure 4-10: Striking an Arc

Arc Length

The securing of an arc length necessary to produce a neat weld soon becomes almost automatic. You will find that a long arc produces more heat. A very long arc produces a crackling or spluttering noise and the weld metal comes across in large, irregular blobs. The weld bead is flattened and spatter increases. A short arc is essential if a high quality weld is to be obtained although if it is too short there is the danger of it being blanketed by slag and the electrode tip being solidified in. If this should happen, give the electrode a quick twist back over the weld to detach it. Contact or "touch-weld" electrodes such as Ferrocraft 21 do not stick in this way, and make welding much easier.

Rate of Travel

After the arc is struck, your next concern is to maintain it, and this requires moving the electrode tip towards the molten pool at the same rate as it is melting away. At the same time, the electrode has to move along the plate to form a bead. The electrode is directed at the weld pool at about 20° from the vertical. The rate of travel has to be adjusted so that a well-formed bead is produced.

If the travel is too fast, the bead will be narrow and strung out and may even be broken up into individual globules. If the travel is too slow, the weld metal piles up and the bead will be too large.

Making Welded Joints

Having attained some skill in the handling of an electrode, you will be ready to go on to make up welded joints.

A. Butt Welds

Set up two plates with their edges parallel, as shown in Figure 4-11, allowing 1.6mm to 2.4mm gap between them and tack weld at both ends. This is to prevent contraction stresses from the cooling weld metal pulling the plates out of alignment. Plates thicker than 6.0mm should have their mating edges bevelled to form a 70° to 90° included angle. This allows full penetration of the weld metal to the root. Using a 3.2mm Ferrocrafter 21 electrode at 100 amps, deposit a run of weld metal on the bottom of the joint.

Do not weave the electrode, but maintain a steady rate of travel along the joint sufficient to produce a well-formed bead. At first you may notice a tendency for undercut to form, but keeping the arc length short, the angle of the electrode at about 20° from vertical, and the rate of travel not too fast, will help eliminate this. The electrode needs to be moved along fast enough to prevent the slag pool from getting ahead of the arc. To complete the joint in thin plate, turn the job over, clean the slag out of the back and deposit a similar weld.

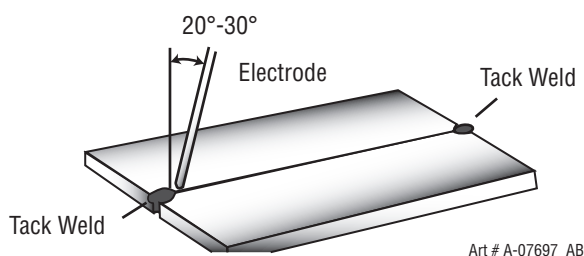


Figure 4-11: Butt Weld

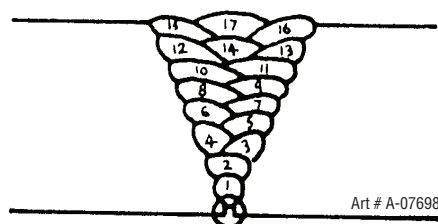


Figure 4-12: Weld Build up Sequence

Heavy plate will require several runs to complete the joint. After completing the first run, chip the slag out and clean the weld with a wire brush. It is important to do this to prevent slag being trapped by the second run. Subsequent runs are then deposited using either a weave technique or single beads laid down in the sequence shown in Figure 4-12. The width of weave should not be more than three times the core wire diameter of the electrode. When the joint is completely filled, the back is either machined, ground or gouged out to remove slag which may be trapped in the root, and to prepare a suitable joint for depositing the backing run. If a backing bar is used, it is not usually necessary to remove this, since it serves a similar purpose to the backing run in securing proper fusion at the root of the weld.

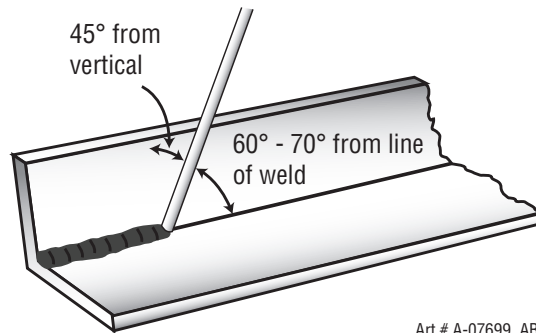
B. Fillet Welds

These are welds of approximately triangular cross-section made by depositing metal in the corner of two faces meeting at right angles. Refer to Figure 4-4.

A piece of angle iron is a suitable specimen with which to begin, or two lengths of strip steel may be tacked together at right angles. Using a 3.2mm Ferrocrafter 21 electrode at 100 amps, position angle iron with one leg horizontal and the other vertical. This is known as a horizontal-vertical (HV) fillet. Strike the arc and immediately bring the electrode to a position perpendicular to the line of the fillet and about 45° from the vertical. Some electrodes require to be sloped about 20° away from the perpendicular position to prevent slag from running ahead of the weld. Refer to Figure 4-13. Do not attempt to build up much larger than 6.4mm width with a 3.2mm electrode, otherwise the weld metal tends to sag towards the base,

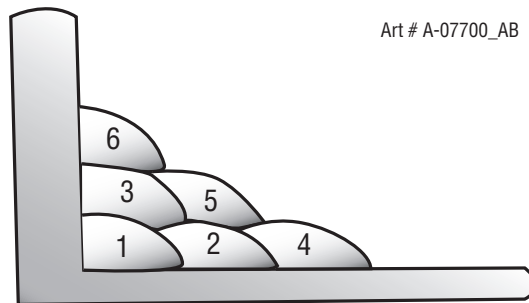
WELDSKILL 200AC/DC INVERTER

and undercut forms on the vertical leg. Multi-runs can be made as shown in Figure 4-14. Weaving in HV fillet welds is undesirable.



Art # A-07699_AB

Figure 4-13: Electrode Position for HV Fillet Weld



Art # A-07700_AB

Figure 4-14: Multi-runs in HV Fillet Weld

C. Vertical Welds

1. Vertical Up

Tack weld a three feet length of angle iron to your work bench in an upright position. Use a 3.2mm Ferrocrafter 21 electrode and set the current at 100 amps. Make yourself comfortable on a seat in front of the job and strike the arc in the corner of the fillet. The electrode needs to be about 10° from the horizontal to enable a good bead to be deposited. Refer Figure 4-15. Use a short arc, and do not attempt to weave on the first run. When the first run has been completed de-slag the weld deposit and begin the second run at the bottom. This time a slight weaving motion is necessary to cover the first run and obtain good fusion at the edges. At the completion of each side motion, pause for a moment to allow weld metal to build up at the edges, otherwise undercut will form and too much metal will accumulate in the centre of the weld. Figure 4-16 illustrates multi-run technique and Figure 4-17 shows the effects of pausing at the edge of weave and of weaving too rapidly.

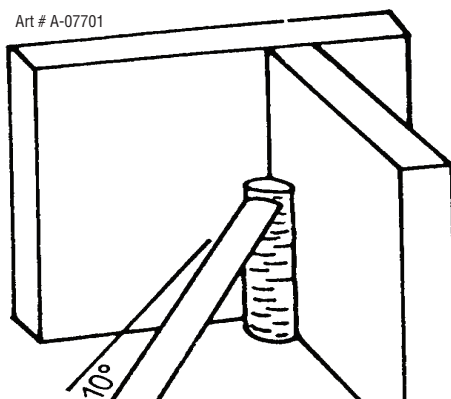


Figure 4-15: Single Run Vertical Fillet Weld

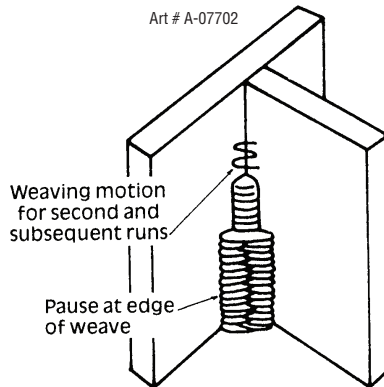


Figure 4-16: Multi Run Vertical Fillet Weld

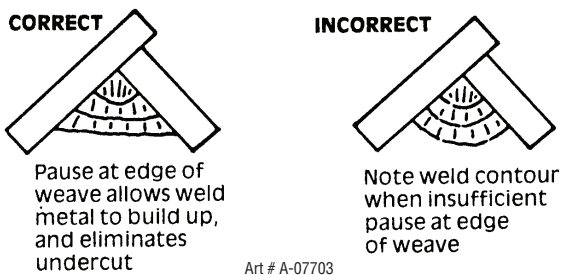


Figure 4-17: Examples of Vertical Fillet Welds

2. Vertical Down

The Ferrocraft 21 electrode makes welding in this position particularly easy. Use a 3.2mm electrode at 100 amps. The tip of the electrode is held in light contact with the work and the speed of downward travel is regulated so that the tip of the electrode just keeps ahead of the slag. The electrode should point upwards at an angle of about 45°.

3. Overhead Welds

Apart from the rather awkward position necessary, overhead welding is not much more difficult than downhand welding. Set up a specimen for overhead welding by first tacking a length of angle iron at right angles to another piece of angle iron or a length of waste pipe. Then tack this to the work bench or hold in a vice so that the specimen is positioned in the overhead position as shown in the sketch. The electrode is held at 45° to the horizontal and tilted 10° in the line of travel (Figure 4-18). The tip of the electrode may be touched lightly on the metal, which helps to give a steady run. A weave technique is not advisable for overhead fillet welds. Use a 3.2mm Ferrocraft 12XP electrode at 100 amps, and deposit the first run by simply drawing the electrode along at a steady rate. You will notice that the weld deposit is rather convex, due to the effect of gravity before the metal freezes.

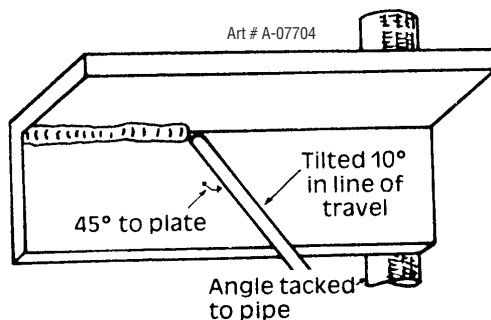


Figure 4-18: Overhead Fillet Weld

Distortion

Distortion in some degree is present in all forms of welding. In many cases it is so small that it is barely perceptible, but in other cases allowance has to be made before welding commences for the distortion that will subsequently occur. The study of distortion is so complex that only a brief outline can be attempted here.

The Cause of Distortion

Distortion is caused by:

A. Contraction of Weld Metal:

Molten steel shrinks approximately 11 per cent in volume on cooling to room temperature. This means that a cube of molten metal would contract approximately 2.2 per cent in each of its three dimensions. In a welded joint, the metal becomes attached to the side of the joint and cannot contract freely. Therefore, cooling causes the weld metal to flow plastically, that is, the weld itself has to stretch if it is to overcome the effect of shrinking volume and still be attached to the edge of the joint. If the restraint is very great, as, for example, in a heavy section of plate, the weld metal may crack. Even in cases where the weld metal does not crack, there will still remain stresses "Locked-up" in the structure. If the joint material is relatively weak, for example, a butt joint in 2.0mm sheet, the contracting weld metal may cause the sheet to become distorted.

B. Expansion and Contraction of Parent Metal in the Fusion Zone:

While welding is proceeding, a relatively small volume of the adjacent plate material is heated to a very high temperature and attempts to expand in all directions. It is able to do this freely at right angles to the surface of the plate (i.e., "through the weld", but when it attempts to expand "across the weld" or "along the weld", it meets considerable resistance, and to fulfil the desire for continued expansion, it has to deform plastically, that is, the metal adjacent to the weld is at a high temperature and hence rather soft, and, by expanding, pushes against the cooler, harder metal further away, and tends to bulge (or is "upset". When the weld area begins to cool, the "upset" metal attempts to contract as much as it expanded, but, because it has been "upset" it does not resume its former shape, and the contraction of the new shape exerts a strong pull on adjacent metal. Several things can then happen.

The metal in the weld area is stretched (plastic deformation), the job may be pulled out of shape by the powerful contraction stresses (distortion), or the weld may crack, in any case, there will remain "locked-up" stresses in the job. Figures 4-19 and 4- 20 illustrate how distortion is created.

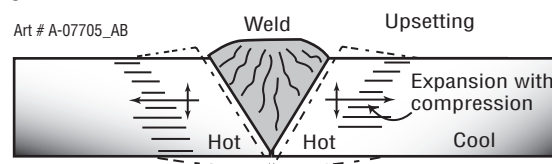


Figure 4-19: Parent Metal Expansion

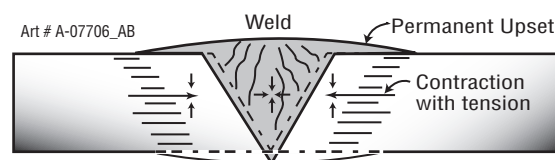


Figure 4-20: Parent Metal Contraction

Overcoming Distortion Effects

There are several methods of minimizing distortion effects.

A. Peening

This is done by hammering the weld while it is still hot. The weld metal is flattened slightly and because of this the tensile stresses are reduced a little. The effect of peening is relatively shallow, and is not advisable on the last layer.

B. Distribution of Stresses

Distortion may be reduced by selecting a welding sequence which will distribute the stresses suitably so that they tend to cancel each other out. See Figures 4-20 through 4-23 for various weld sequences. Choice of a suitable weld sequence is probably the most effective method of overcoming distortion, although an unsuitable sequence may exaggerate it. Simultaneous welding of both sides of a joint by two welders is often successful in eliminating distortion.

C. Restraint of Parts

Forcible restraint of the components being welded is often used to prevent distortion. Jigs, positions, and tack welds are methods employed with this in view.

D. Presetting

It is possible in some cases to tell from past experience or to find by trial and error (or less frequently, to calculate) how much distortion will take place in a given welded structure. By correct pre-setting of the components to be welded, constructional stresses can be made to pull the parts into correct alignment. A simple example is shown in Figure 4-21.

E. Preheating

Suitable preheating of parts of the structure other than the area to be welded can be sometimes used to reduce distortion. Figure 4-22 shows a simple application. By removing the heating source from b and c as soon as welding is completed, the sections b and c will contract at a similar rate, thus reducing distortion.

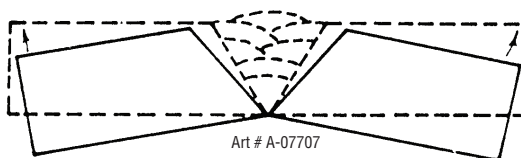
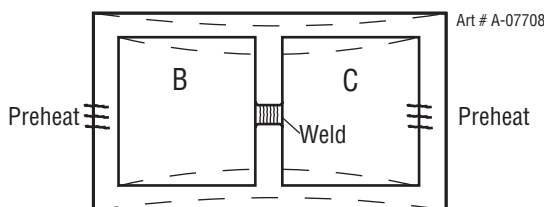


Figure 4-21: Principle of Presetting



Dotted lines show effect if no preheat is used

Figure 4-22: Reduction of Distortion by Preheating

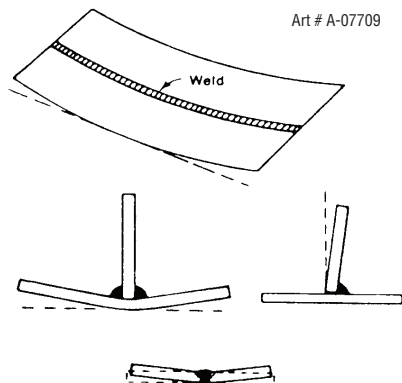


Figure 4-23: Examples of Distortion

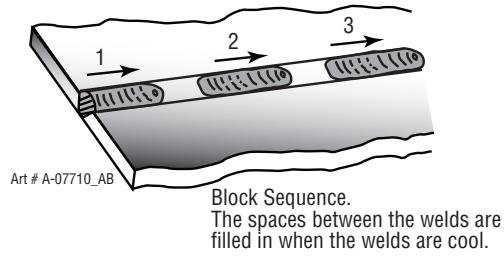


Figure 4-24: Welding Sequence

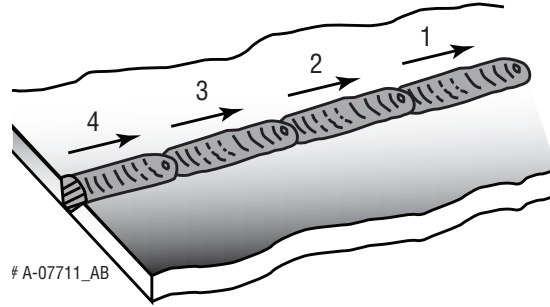


Figure 4-25: Step back Sequence

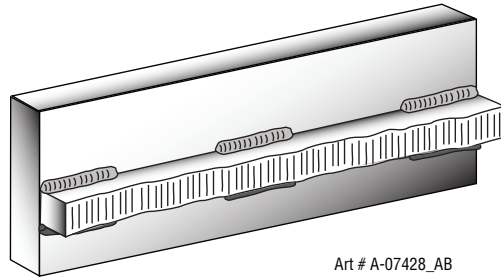


Figure 4-26: Chain Intermittent Welding

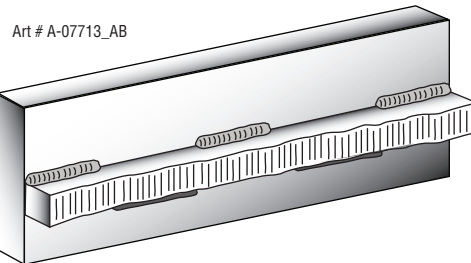


Figure 4-27: Staggered Intermittent Welding

Electrode Selection Chart

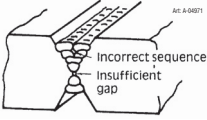
CIGWELD Electrode Selection Chart				
Description	Diameter	Pack	Part No.	Application
Satincraft 13	2.5mm	1kg	322135	General purpose electrode suitable for all positional welding and galvanised steel.
	2.5mm	2.5kg	612182	
	3.2mm	1kg	322136	
	3.2mm	2.5kg	612183	
	4.0mm	5kg	611184	
Ferrocraft 12XP	2.0mm	1kg	322128	General purpose, Xtra performance electrode recommended for all positional (inc. Vertical down) welding of mild and galvanised steel.
	2.0mm	2.5kg	612231	
	2.5mm	1kg	322129	
	2.5mm	2.5kg	612232	
	3.2mm	1kg	322138	
	3.2mm	2.5kg	612233	
WeldSkill GP	2.0mm	1 kg	WEG1020	User-friendly GP electrode for welding thin section mild and galvanised steels. Excellent for vertical down fillet welding applications.
	2.0mm	2.5 kg	WEG2520	
	2.5mm	1 kg	WEG1025	
	2.5mm	2.5 kg	WEG2525	
	2.5mm	5 kg	WEG5025	
	3.2mm	1 kg	WEG1032	
	3.2mm	2.5 kg	WEG2532	
	3.2mm	5 kg	WEG5032	
Ferrocraft 16 Twincoat	2.5mm	2.5 kg	612752	Hydrogen Controlled type offering exceptional AC/DC performance in all welding positions.
	2.5mm	5 kg	611752	
	3.2mm	2.5 kg	612753	
	3.2mm	5 kg	611753	
	4.0mm	5 kg	611754	
Satinchrome 308L-17	2.5mm	2.5 kg	611602	Stainless Steel type for 19Cr/10Ni stainless grades including 201, 202, 301, 302, 303, 304, 304L, 305, 308, etc
	3.2mm	2.5 kg	611603	
	4.0mm	2.5 kg	611604	
Satinchrome 309Mo-17	2.5mm	2.5 kg	611692	Stainless Steel type for 309 and 309L grades. It is also suitable for welding of dissimilar welding of other 300 series stainless steels.
	3.2mm	2.5 kg	611693	
	4.0mm	2.5 kg	611694	
Satinchrome 316L-17	2.0mm	2,5 kg	611661	Stainless Steel type for welding of matching Mo bearing grades, 316 and 316L.
	2.5mm	2.5 kg	611662	
	3.2mm	2.5 kg	611663	
	2.5/3.2mm	Blisterpack	322215	
	4.0mm	2.5 kg	611664	
Weldall	2.5mm	2.5 kg	611702	High alloy stainless steel type for welding of unknown steels, repair of die or tool steels and for joining dissimilar steels. (Not recommended for cast iron).
	3.2mm	2.5 kg	611703	
	2.5/3.2mm	Blisterpack	322216	
	4.0mm	2.5 kg	611704	
Castcraft 55	3.2mm	2.5 kg	611723	For repair and maintenance welding of S.G. cast iron, meehanites and other cast irons. It produces high strength weld than Castcraft 100.
	4.0mm	2.5 kg	611724	
Castcraft 100	2.5mm	2.5 kg	611732	Soft, Ductile Nickel type electrode for repair and maintenance welding of a wide range of cast irons. It has better "wetting" action than Castcraft 55.
	3.2mm	2.5 kg	611733	
	2.5/3.2mm	Blisterpack	322217	
	4.0mm	2.5 kg	611734	

Table 4-1: CIGWELD Electrode Selection Chart

Further information on CIGWELD electrodes can be found at the website www.cigweld.com.au

WELDSKILL 200AC/DC INVERTER

4.02 Stick (MMAW) Welding Troubleshooting

FAULT	CAUSE	REMEDY
1 Welding current varying	ARC FORCE control knob is set at a value that causes the welding current to vary excessively with the arc length.	Reduce the ARC FORCE control knob until welding current is reasonably constant while prohibiting the electrode from sticking to the work piece when you “dig” the electrode into the workpiece.
2 A gap is left by failure of the weld metal to fill the root of the weld.	A Welding current too low B Electrode too large for joint. C Insufficient gap.	A Increase welding current. B Use smaller diameter electrode. C Allow wider gap.
3 Non-metallic particles are trapped in the weld metal.	A Non-metallic particles may be trapped in undercut from previous run. B Joint preparation too restricted. C Irregular deposits allow slag to be trapped. D Lack of penetration with slag trapped beneath weld bead. E Rust or mill scale is preventing full fusion. F Wrong electrode for position in which welding is done.	A If a bad undercut is present clean slag bout and cover with a run from a smaller gauge electrode. B Allow for adequate penetration and room for cleaning out the slag. C If very bad, chip or grind out irregularities. D Use smaller electrode with sufficient current to give adequate penetration. Use suitable tools to remove all slag from comers. E Clean joint before welding. F Use electrodes designed for position in which welding is done, otherwise proper control of slag is difficult.
 <p>Figure 1-Example of insufficient gap or incorrect sequence</p>		
4 A groove has been formed in the base metal adjacent to the toe of a weld and has not been filled by the weld metal (undercut).	A Welding current is too high. B Welding arc is too long. C Angle of the electrode is incorrect. D Joint preparation does not allow correct electrode angle. E Electrode too large for joint. F Insufficient deposit time at edge of weave.	A Reduce welding current. B Reduce the length of the welding arc. C Electrode should not be inclined less than 45° to the vertical face. D Allow more room in joint for manipulation of the electrode. E Use smaller gauge electrode. F Pause for a moment at edge of weave to allow weld metal buildup.

<p>5 Portions of the weld run do not fuse to the surface of the metal or edge of the joint.</p>	<p>A Small electrodes used on heavy cold plate. B Welding current is too low. C Wrong electrode angle. D Travel speed of electrode is too high. E Scale or dirt on joint surface.</p>	<p>A Use larger electrodes and preheat the plate. B Increase welding current. C Adjust angle so the welding arc is directed more into the base metal. D Reduce travel speed of electrode. E Clean surface before welding.</p>
---	---	---

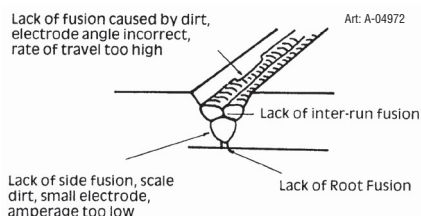


Figure 2: Example of Lack of Fusion

<p>6 Gas pockets or voids in weld metal (porosity)</p>	<p>A High levels of sulphur in steel. B Electrodes are damp. C Welding current is too high. D Surface impurities such as oil, grease, paint, etc. E Welding in a windy environment. F Electrode damaged ie flux coating incomplete.</p>	<p>A Use an electrode that is designed for high sulphur steels. B Dry electrodes before use. C Reduce welding current. D Clean joint before welding. E Shield the weld area from the wind. F Discard damaged electrodes and only use electrodes with a complete flux coating.</p>
--	--	--

<p>7 Crack occurring in weld metal soon after solidification commences</p>	<p>A Rigidity of joint. B Insufficient throat thickness. C Weld current is too high.</p>	<p>A Redesign to relieve weld joint of severe stresses or use crack resistance electrodes. B Travel slightly slower to allow greater build up in throat. C Decrease welding current.</p>
--	--	--

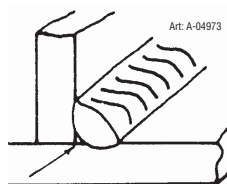
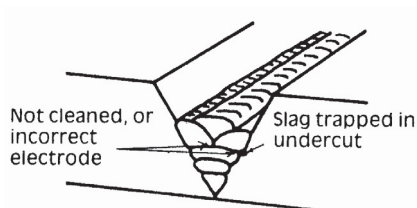


Figure 3: Example of Slag Inclusion

Table 4-2: Welding Problems MMAW (Stick)

WELDSKILL 200AC/DC INVERTER

4.03 TIG (GTAW) Basic Welding Technique

Gas Tungsten Arc Welding (GTAW) or TIG (Tungsten Inert Gas) as it is commonly referred to, is a welding process in which fusion is produced by an electric arc that is established between a single tungsten (non-consumable) electrode and the work piece. Shielding is obtained from a welding grade shielding gas or welding grade shielding gas mixture which is generally Argon based. A filler metal may also be added manually in some circumstances depending on the welding application.

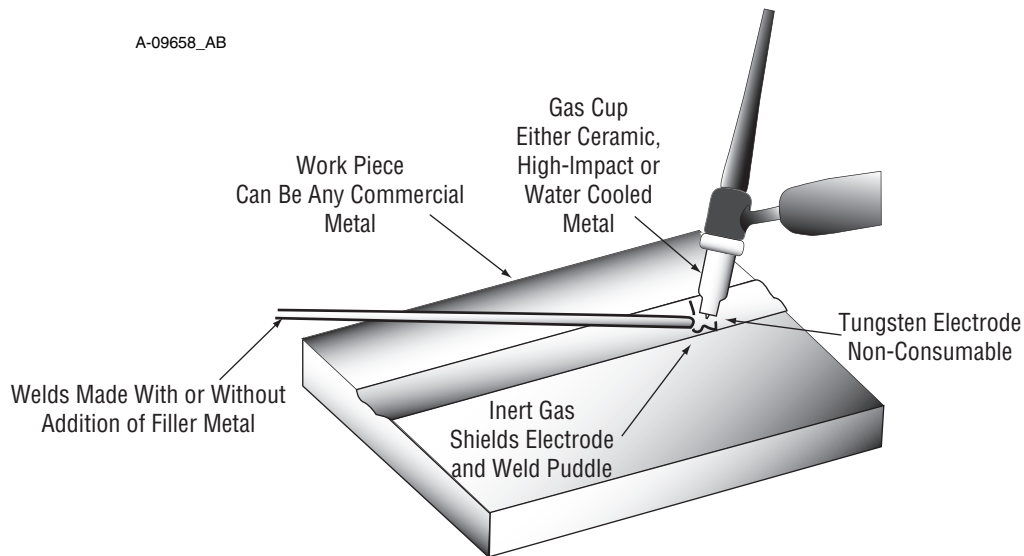


Figure 4-28: TIG Welding Application Shot

Tungsten Electrode Current Ranges

Electrode Diameter	DC Current (Amps)
0.040" (1.0mm)	30-60
1/16" (1.6mm)	60-115
3/32" (2.4mm)	100-165
1/8" (3.2mm)	135-200
5/32" (4.0mm)	190-280
3/16" (4.8mm)	250-340

Table 4-3: Current Ranges for Various Tungsten Electrode Sizes

Guide for Selecting Filler Wire Diameter

Filler Wire Diameter	DC Current Range (Amps)
1/16" (1.6mm)	20-90
3/32" (2.4mm)	65-115
1/8" (3.2mm)	100-165
3/16" (4.8mm)	200-350

Table 4-4: Filler Wire Selection Guide

Tungsten Electrode Types

Electrode Type (Ground Finish)	Welding Application	Features	Colour Code
Thoriated 2%	DC welding of mild steel, stainless steel and copper	Excellent arc starting, Long life, High current carrying capacity	Red
Zirconated 1%	High quality AC welding of aluminium, magnesium and their alloys.	Self cleaning, Long life, Maintains balled end, High current carrying capacity.	White
Ceriated 2%	AC & DC welding of mild steel, stainless steel, copper, aluminium, magnesium and their alloys	Longer life, More stable arc, Easier starting, Wider current range, Narrower more concentrated arc.	Grey

Table 4-5 Tungsten Electrode Types

TIG Welding Filler Rods

Comweld Rod	Aust Std	AWS Std	Part No. 1.6mm	Part No. 2.4mm	Part No. 3.2mm	Type/Application
LW1 LW1-6 Supersteel	R4 R6 R2	ER70S-4 ER70S-6 ER70S-2	321411 321417 321370	— — —	— — —	For mild-medium strength steels. Pipes, tubing, roll cages, etc.
CrMo1 CrMo2	RB2 RB3	ER80S-B2 ER90S-B3	— —	321379 321383	— —	For welding of high strength Cr-Mo steels used at elevated temperatures.
308L 309L 316L	R308L R309L R316L	ER308L ER309L ER316L	321406 321403 321400	321407 321404 321401	— — —	For stainless steels. Stainless pipes, tubing, architectural uses, etc.

Table 4-6 TIG Welding Filler Rods

Base Metal Thickness	DC Current for Mild Steel	DC Current for Stainless Steel	Tungsten Electrode Diameter	Filler Rod Diameter (if required)	Argon Gas Flow Rate Litres/min	Joint Type
0.040" 1.0mm	35-45 40-50	20-30 25-35	0.040" 1.0mm	1/16" 1.6mm	5-7	Butt/Corner Lap/Fillet
0.045" 1.2mm	45-55 50-60	30-45 35-50	0.040" 1.0mm	1/16" 1.6mm	5-7	Butt/Corner Lap/Fillet
1/16" 1.6mm	60-70 70-90	40-60 50-70	1/16" 1.6mm	1/16" 1.6mm	7	Butt/Corner Lap/Fillet
1/8" 3.2mm	80-100 90-115	65-85 90-110	1/16" 1.6mm	3/32" 2.4mm	7	Butt/Corner Lap/Fillet
3/16" 4.8mm	115-135 140-165	100-125 125-150	3/32" 2.4mm	1/8" 3.2mm	10	Butt/Corner Lap/Fillet
1/4" 6.4mm	160-175 170-200	135-160 160-180	1/8" 3.2mm	5/32" 4.0mm	10	Butt/Corner Lap/Fillet

Table 4-7 Welding Rate

WELDSKILL 200AC/DC INVERTER

TIG Welding is generally regarded as a specialised process that requires operator competency. While many of the principles outlined in the previous Arc Welding section are applicable a comprehensive outline of the TIG Welding process is outside the scope of this Operating Manual. For further information please refer to www.cigweld.com.au or contact CIGWELD.

4.04 TIG (GTAW) Welding Problems

FAULT	CAUSE	REMEDY
1 Excessive bead build up or poor penetration or poor fusion at edges of weld.	Welding current is too low	Increase weld current and/or faulty joint preparation.
2 Weld bead too wide and flat or undercut at edges of weld or excessive burn through.	Welding current is too high	Decrease weld current.
3 Weld bead too small or insufficient penetration or ripples in bead are widely spaced apart.	Travel speed too fast	Reduce travel speed.
4 Weld bead too wide or excessive bead build up or excessive penetration in butt joint.	Travel speed too slow	Increase travel speed.
5 Uneven leg length in fillet joint	Wrong placement of filler rod	Re-position filler rod.
6 Electrode melts or oxidises when an arc is struck.	<p>A Torch lead connected to positive welding terminal.</p> <p>B No gas flowing to welding region.</p> <p>C Torch is clogged with dust or dirt.</p> <p>D Gas hose is cut.</p> <p>E Gas passage contains impurities.</p> <p>F Gas regulator turned off.</p> <p>G The electrode is too small for the welding current.</p> <p>H Power source is set for STICK welding.</p>	<p>A Connect torch lead to negative welding terminal.</p> <p>B Check the gas lines for kinks or breaks and gas cylinder contents.</p> <p>C Clean torch.</p> <p>D Replace gas hose.</p> <p>E Disconnect gas hose from the rear of Power Source then raise gas pressure and blow out impurities.</p> <p>F Turn on.</p> <p>G Increase electrode diameter or reduce the welding current.</p> <p>H Set Power Source to LIFT TIG or HF TIG mode.</p>

7 Dirty weld pool	A Electrode contaminated by contact with work piece or filler rod material. B Work piece surface has foreign material on it. C Gas contaminated with air.	A Clean the electrode by grinding off the contaminates. B Clean surface. C Check gas lines for cuts and loose fitting or change gas cylinder.
8 Poor weld finish	Inadequate shielding gas.	Increase gas flow or check gas line for gas flow problems.
9 Arc start is not smooth.	A Tungsten electrode is too large for the welding current. B The wrong electrode is being used for the welding job. C Gas flow rate is too high. D Incorrect shielding gas is being used. E Poor work clamp connection to work piece.	A Select the right size tungsten electrode. Refer to Table 4-3 CIGWELD Tungsten Electrode Selection Chart. B Select the right tungsten electrode type. Refer to Table 4-5 CIGWELD Tungsten Electrode Selection Chart. C Select the right rate for the welding job. Refer to Table 4-7. D Select the right shielding gas. E Improve connection to work piece.
10 Arc flutters during TIG welding.	Tungsten electrode is too large for the welding current.	Select the right size tungsten electrode. Refer to Table 4-3 CIGWELD Tungsten Electrode Selection Chart.

This page is left blank intentionally.

**SECTION 5:
POWER SOURCE PROBLEMS AND ROUTINE SERVICE
REQUIREMENTS**

5.01 Basic Troubleshooting



WARNING

There are extremely dangerous voltage and power levels present inside this product. Do not attempt to open or repair unless you are a qualified electrical tradesperson and you have had training in power measurements and troubleshooting techniques.

If major complex subassemblies are faulty, then the Welding Power Source must be returned to an accredited CIGWELD Service Provider for repair. The basic level of troubleshooting is that which can be performed without special equipment or knowledge. Refer also to section 4 for solving welding problems.

5.02 Power Source Problems

FAULT	CAUSE	REMEDY
1 Mains supply voltage is ON, power indicator is illuminated however unit will not commence welding when the torch trigger switch is depressed.	A Power source is not in the correct mode of operation. B Faulty torch trigger.	A Set the power source to the correct mode of operation with the process selection switch. B Repair or replace torch trigger switch/lead.
2 Mains supply voltage is ON. Indicator light is not lit and welding arc cannot be established.	A Primary control fuse is blown. B Broken connection in primary circuit.	A Replace primary control fuse. B Have an Accredited CIGWELD Service Provider check primary circuit.
3 Fault Indicator is illuminated and unit will not commence welding when the torch trigger switch is depressed.	Duty cycle of power source has been exceeded.	Leave the power source switched ON and allow it to cool. Note that fault indicator must be extinguished prior to commencement of welding.
4 Welding output continues when torch trigger released	A Trigger mode selection is in 4T (LATCH) mode B Torch trigger leads shorted	A Change to 2T (NORMAL) mode B Repair or replace Torch / trigger lead
5 Welding output voltage is present when the torch trigger switch is depressed but arc cannot be established.	Poor or no work lead contact.	Clean work clamp area and ensure good electrical contact.
6 Welding output voltage is not present when torch trigger depressed	Faulty trigger switch / lead	Repair or replace Torch / trigger lead
7 TIG electrode melts when arc is struck.	TIG torch is connected to the (+) VE terminal.	Connect the TIG torch to the (-) VE terminal.
8 Arc flutters during TIG welding.	Tungsten electrode is too large for the welding current.	Select the correct size of tungsten electrode.
9 No HF output in HF mode	HF Circuit faulty	Have an Accredited CIGWELD Service Provider check HF circuit.

The owners of the equipment shall keep a suitable record of the periodic tests and a system of tagging, including the date of the most recent inspection.

A transportable power source is deemed to be any equipment that is not permanently connected and fixed in the position in which it is operated.

B. Insulation Resistance

Minimum insulation resistance for in-service CIGWELD Inverter Power Sources shall be measured at a voltage of 500V between the parts referred to in Table 5-2 below. Power sources that do not meet the insulation resistance requirements set out below shall be withdrawn from service and not returned until repairs have been performed such that the requirements outlined below are met.

Components to be Tested	Minimum Insulation Resistance (M Ω)
Input circuit (including any connected control circuits) to welding circuit (including any connected control circuits)	5
All circuits to exposed conductive parts	2.5
Welding circuit (including any connected control circuits) to any auxiliary circuit which operates at a voltage exceeding extra low voltage	10
Welding circuit (including any connected control circuits) to any auxiliary circuit which operates at a voltage not exceeding extra low voltage	1
Separate welding circuit to separate welding circuit	1

Table 5-2: Minimum Insulation Resistance Requirements: CIGWELD Inverter Power Sources

C. Earthing

The resistance shall not exceed 1 Ω between any metal of a power source where such metal is required to be earthed, and -

1. The earth terminal of a fixed power source; or
2. The earth terminal of the associated plug of a transportable power source

Note that due to the dangers of stray output currents damaging fixed wiring, the integrity of fixed wiring supplying CIGWELD welding power sources should be inspected by a licensed electrical worker in accordance with the requirements below -

1. For outlets/wiring and associated accessories supplying transportable equipment - at least once every 3 months; and
2. For outlets/wiring and associated accessories supplying fixed equipment - at least once every 12 months.

D. General Maintenance Checks

Welding equipment should be regularly checked by an accredited CIGWELD Service Provider to ensure that:

1. Flexible cord is of the multi-core tough rubber or plastic sheathed type of adequate rating, correctly connected and in good condition.
2. Welding terminals are in suitable condition and are shrouded to prevent inadvertent contact or short circuit.
3. The Welding System is clean internally, especially from metal filing, slag, and loose material.

WELDSKILL 200AC/DC INVERTER

E. Accessories

Accessory equipment, including output leads, electrode holders, torches, wire feeders and the like shall be inspected at least monthly by a competent person to ensure that the equipment is in a safe and serviceable condition. All unsafe accessories shall not be used.

F. Repairs

If any parts are damaged for any reason, it is recommended that replacement be performed by an accredited CIGWELD Service Provider.

Power Source Calibration

A. Schedule

Output testing of all CIGWELD Inverter Power Sources and applicable accessories shall be conducted at regular intervals to ensure they fall within specified levels. Calibration intervals shall be as outlined below -

1. For transportable equipment, at least once every 3 months; and
2. For fixed equipment, at least once every 12 months.

If equipment is to be used in a hazardous location or environments with a high risk of electrocution as outlined in AS 1674.2 - 2007, then the above tests should be carried out prior to entering this location.

B. Calibration Requirements

Where applicable, the tests outlined in Table 5-3 below shall be conducted by an accredited CIGWELD service provider.

Testing Requirements
Output current (A) to be checked to ensure it falls within applicable CIGWELD power source specifications
Output Voltage (V) to be checked to ensure it falls within applicable CIGWELD power source specifications
Accuracy of digital meters to be checked to ensure it falls within applicable CIGWELD power source specifications

Table 5-3: Calibration Parameters

Periodic calibration of other parameters such as timing functions are not required unless a specific fault has been identified.

C. Calibration Equipment

All equipment used for Power Source calibration shall be in proper working condition and be suitable for conducting the measurement in question. Only test equipment with valid calibration certificates (NATA certified laboratories) shall be utilized.

5.04 Cleaning the Welding Power Source

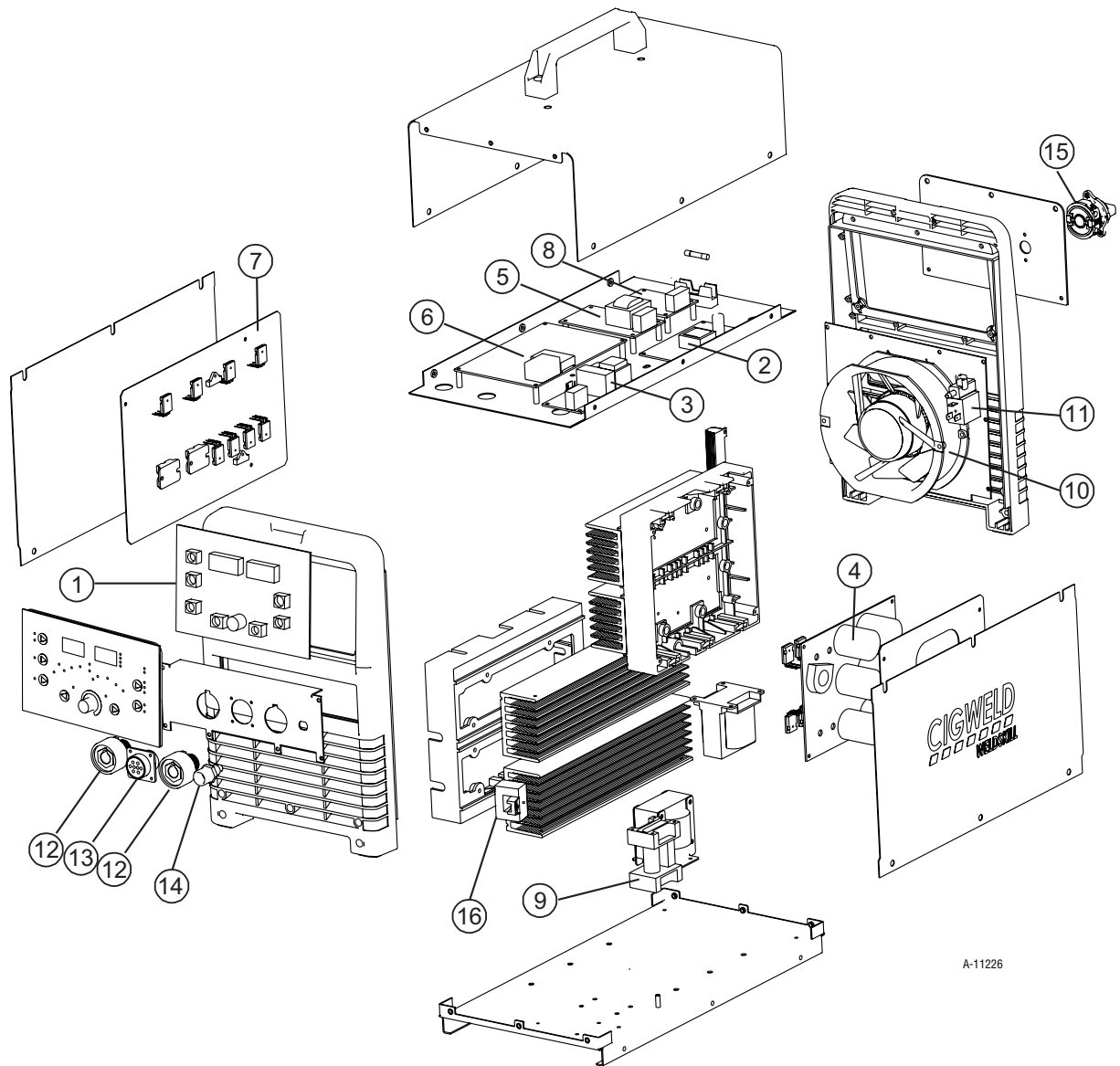


There are dangerous voltage and power levels present inside this product. Do not attempt to open or repair unless you are a qualified electrical tradesperson. Disconnect the Welding Power Source from the Mains Supply Voltage before disassembling.

To clean the Welding Power Source, open the enclosure and use a vacuum cleaner to remove any accumulated dirt, metal filings, slag and loose material. Keep the shunt and lead screw surfaces clean as accumulated foreign material may reduce the welders output welding current.

SECTION 6:
KEY SPARE PARTS

6.01 Power Source



A-11226

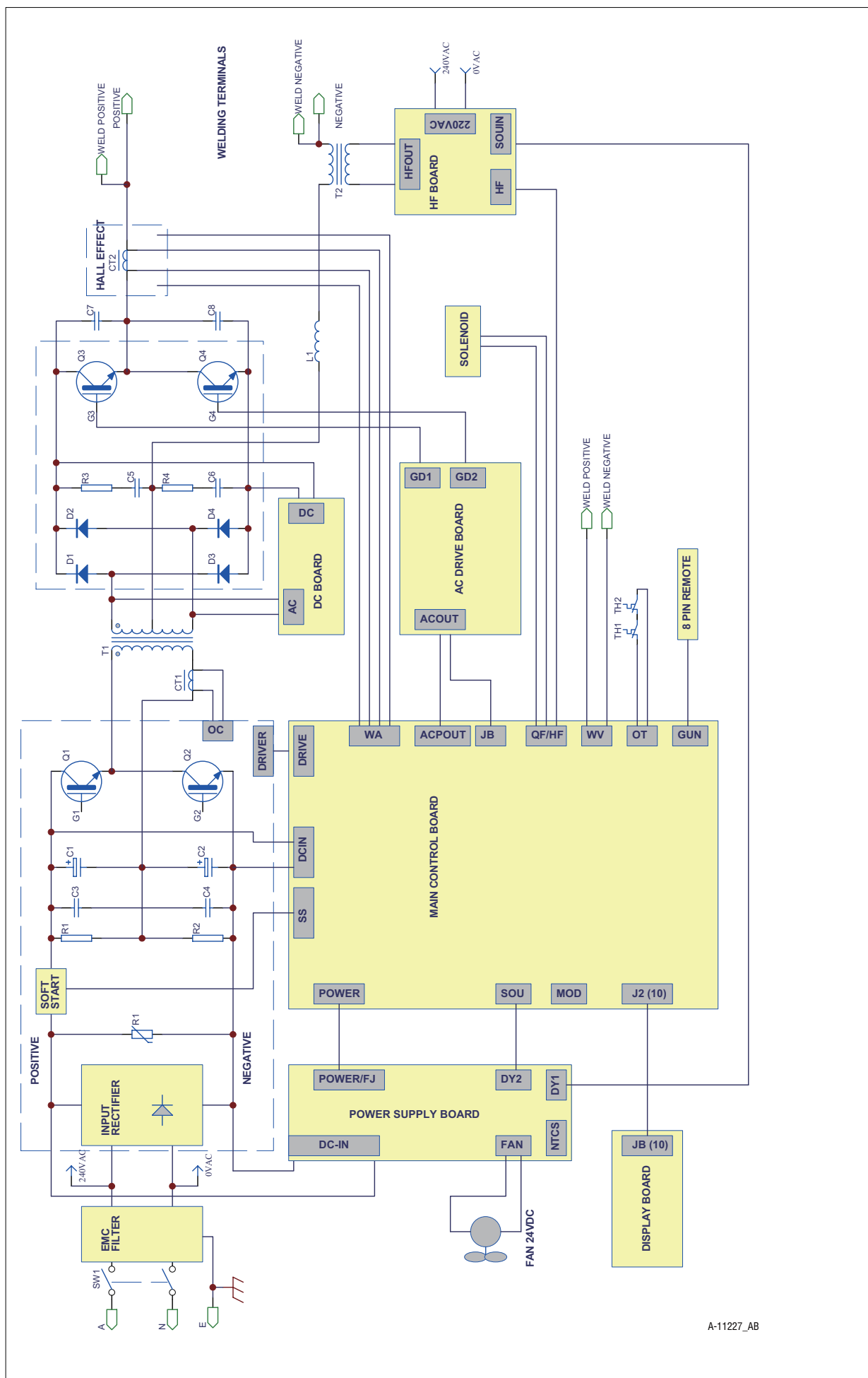
Figure 6-1

WELDSKILL 200AC/DC INVERTER

WeldSkill 200AC/DC Spare Parts		
Item	Part Number	Description
1	W7005500	PCB display
2	W7005502	PCB HF
3	W7005503	PCB aux power supply
4	W7005504	PCB primary inverter
5	W7005505	PCB AC output drive
6	W7005506	PCB control
7	W7005507	PCB secondary rectifier
8	W7005508	PCB EMC filter
9	W7005509	Coil coupling
10	W7005512	Fan assembly
11	W7003033	Gas solenoid assembly
12	W7005513	Dinse Socket 50mm ²
13	W7003036	Control socket 8 pin, (Note that 8 pin control plug part number is UOA706900)
14	W7005514	Gas outlet, front panel
15	W7005515	Switch On/Off
16	W7003076	CT, output
17	704461	Dinse plug male 50mm ² (not shown)

Table 6-1

APPENDIX: CIRCUIT DIAGRAM



A-11227_AB

CIGWELD - LIMITED WARRANTY TERMS

LIMITED WARRANTY: CIGWELD Pty Ltd, A Victor Technologies Company, hereafter, "CIGWELD" warrants to customers of its authorized distributors hereafter "Purchaser" that its products will be free of defects in workmanship or material. Should any failure to conform to this warranty appear within the time period applicable to the CIGWELD products as stated below, CIGWELD shall, upon notification thereof and substantiation that the product has been stored, installed, operated, and maintained in accordance with CIGWELD's specifications, instructions, recommendations and recognized standard industry practice, and not subject to misuse, repair, neglect, alteration, or accident, correct such defects by suitable repair or replacement, at CIGWELD's sole option, of any components or parts of the product determined by CIGWELD to be defective.

CIGWELD MAKES NO OTHER WARRANTY, EXPRESS OR IMPLIED. THIS WARRANTY IS EXCLUSIVE AND IN LIEU OF ALL OTHERS, INCLUDING, BUT NOT LIMITED TO ANY WARRANTY OF MERCHANTABILITY OR FITNESS FOR ANY PARTICULAR PURPOSE.

LIMITATION OF LIABILITY: CIGWELD SHALL NOT UNDER ANY CIRCUMSTANCES BE LIABLE FOR SPECIAL, INDIRECT OR CONSEQUENTIAL DAMAGES, SUCH AS, BUT NOT LIMITED TO, LOST PROFITS AND BUSINESS INTERRUPTION. The remedies of the Purchaser set forth herein are exclusive and the liability of CIGWELD with respect to any contract, or anything done in connection therewith such as the performance or breach thereof, or from the manufacture, sale, delivery, resale, or use of any goods covered by or furnished by CIGWELD whether arising out of contract, negligence, strict tort, or under any warranty, or otherwise, shall not, except as expressly provided herein, exceed the price of the goods upon which such liability is based. No employee, agent, or representative of CIGWELD is authorized to change this warranty in any way or grant any other warranty.

PURCHASER'S RIGHTS UNDER THIS WARRANTY ARE VOID IF REPLACEMENT PARTS OR ACCESSORIES ARE USED WHICH IN CIGWELD'S SOLE JUDGEMENT MAY IMPAIR THE SAFETY OR PERFORMANCE OF ANY CIGWELD PRODUCT. PURCHASER'S RIGHTS UNDER THIS WARRANTY ARE VOID IF THE PRODUCT IS SOLD TO PURCHASER BY NON-AUTHORIZED PERSONS.

The warranty is effective for the time stated below beginning on the date that the authorized distributor delivers the products to the Purchaser. Notwithstanding the foregoing, in no event shall the warranty period extend more than the time stated plus one year from the date CIGWELD delivered the product to the authorized distributor.

TERMS OF WARRANTY – JANUARY 2012

1. The Trade Practices Act 1974 (Commonwealth) and similar State Territory legislation relating to the supply of goods and services, protects consumers' interests by ensuring that consumers are entitled in certain situations to the benefit of various conditions, warranties, guarantees, rights and remedies (including warranties as to merchantability and fitness for purpose) associated with the supply of goods and services. A consumer should seek legal advice as to the nature and extent of these protected interests. In some circumstances, the supplier of goods and services may legally stipulate that the said conditions, warranties, guarantees, rights and remedies are limited or entirely excluded. The warranties set out in Clause 2 shall be additional to any nonexcludable warranties to which the Customer may be entitled pursuant to any statute.
2. Subject to Clause 3. CIGWELD gives the following warranties to the Customer:

Insofar as they are manufactured or imported by CIGWELD, goods will upon delivery be of merchantable quality and reasonably fit for the purpose for which they are supplied by CIGWELD.

CIGWELD will repair or, at its option, replace those of the goods which, upon examination, are found by CIGWELD to be defective in workmanship and/or materials.

CIGWELD reserves the right to request documented evidence of date of purchase.
3. The Warranty in Clause 2;

Is conditional upon:

The Customer notifying CIGWELD or our Accredited Distributor in writing of its claim within seven (7) days of becoming aware of the basis thereof, and at its own expense returning the goods which are the subject of the claim to CIGWELD or nominated Accredited Distributor/Accredited Service Provider. The goods being used in accordance with the Manufacturer's Operating Manuals, and under competent supervision.

Does not apply to:

Obsolete goods sold at auction, second-hand goods and prototype goods.

Breakdown or malfunction caused by accident, misuse or normal wear and tear.

Repairs or replacement made other than by CIGWELD or Accredited Service Providers, unless by prior arrangement with CIGWELD.

Replacement parts or accessories which may affect product safety or performance and which are not manufactured, distributed or approved by CIGWELD.
4. CIGWELD declares that, to the extent permitted by law, it hereby limits its liability in respect of the supply of goods which are not of a kind ordinarily acquired for personal, domestic or household use or consumption to any one or more of the following (the choice of which shall be at the option of CIGWELD).
- The replacement of the goods or the supply of equivalent goods.
- The repair of goods.
- The payment of cost of replacing the goods or acquiring equivalent goods.
- The payment of the cost of having goods repaired.
5. Except as provided in Clauses 2 to 4 above, to the extent permitted by statute, CIGWELD hereby excludes all liability for any loss, damage, death or injury of any kind whatsoever occasioned to the Customer in respect of the supply of goods including direct, indirect, consequential or incidental loss, damage or injury of any kind.

WARRANTY SCHEDULE – JANUARY 2012

These warranty periods relate to the warranty conditions in clause 2. All warranty periods are from date of sale from the Accredited Distributor of the equipment. Notwithstanding the foregoing, in no event shall the warranty period extend more than the time stated plus one year from the date CIGWELD delivered the product to the Accredited Distributor. Unless otherwise stated the warranty period includes parts and labour. CIGWELD reserves the right to request documented evidence of date of purchase.

WELDSKILL 200AC/DC POWER SOURCE	WARRANTY PERIOD	
	PARTS	LABOUR
Original main power magnetics.	1 Year	1 Year
Original main power rectifiers, printed circuit boards and power switch semiconductors.	1 Year	1 Year
All other circuits and components including, but not limited to, relays, switches, contactors, solenoids, fans and electric motors.	1 Year	1 Year
ACCESSORIES	WARRANTY PERIOD	
TIG torch, electrode holder lead and work lead.	3 Months	
TIG torch consumable items.	NIL	
Gas regulator/flowmeter (excluding seat assembly, pressure gauges, elastomer seals and "O" rings).	1 Year	
Regulator seat assemblies and pressure gauges.	6 Months	
Elastomer seals and "O" rings used in the equipment.	3 Months	

Please note that the information detailed in this statement supersedes any prior published data produced by CIGWELD.

CIGWELD Terms of Warranty - 2012

Effective 1st January 2012, all warranties against defects (also known as a manufacturer's warranty) supplied with goods or services must comply with the mandatory requirements in the new Australian Consumer Law and the Trade Practices (Australian Consumer Law) Amendment Regulations (2010) (No.1).

This Warranty Statement should be read in conjunction with the Warranty Schedule contained in the operating instructions of the product. This schedule contains the warranty period applicable to the product

Any claim under this warranty must be made within the warranty period which commences on the date of purchase of the product. To make a claim under the warranty, take the product (with proof of purchase from a Cigweld Accredited Seller) to the store where you purchased the product or contact Cigweld Customer Care 1300 654 674 for advice on your nearest Service Provider.

All costs associated with lodging the warranty claim including the return of goods to Cigweld or our Nominated Accredited Distributor / Accredited Service Provider are the responsibility of the consumer.

This warranty is given.

Cigweld Pty Ltd
A.B.N. 56007226815
71 Gower Street, Preston
Victoria, Australia, 3072
Phone: 1300 654 674
Email: enquiries@cigweld.com.au
Website: www.cigweld.com.au

This warranty is provided in addition to other rights and remedies you have under law: Our goods come with guarantees which cannot be excluded under the Australian Consumer Law. You are entitled to replacement or refund for a major failure and to compensation for other reasonably foreseeable loss or damage. You are also entitled to have the goods repaired or replaced if the goods fail to be of acceptable quality and the failure does not amount to a major failure.

Failures due to incorrect use are not covered by this warranty and consumers are reminded to only use the product in accordance with the Operating Instruction supplied with the product. Additional copies of Operating Instructions are available from Cigweld Customer Care 1300 654 674 or the Website.



GLOBAL CUSTOMER SERVICE CONTACT INFORMATION

CIGWELD, Australia

71 Gower Street
Preston, Victoria
Australia, 3072
Telephone: 61-3-9474-7400
Fax: 61-3-9474-7391
Email: enquiries@cigweld.com.au

Victor Technologies USA

2800 Airport Road
Denton, Tx 76207 USA
Telephone: (940) 566-2000
800-426-1888
Fax: 800-535-0557
Email: sales@thermalarc.com

Victor Technologies Canada

2070 Wyecroft Road
Oakville, Ontario
Canada, L6L5V6
Telephone: (905)-827-1111
Fax: 905-827-3648

Victor Technologies Europe

Europe Building
Chorley North Industrial Park
Chorley, Lancashire
England, PR6 7Bx
Telephone: 44-1257-261755
Fax: 44-1257-224800

PT. Victor Technologies Utama Indonesia

Jl. Angsana II Blok AE No. 28
Delta Silicon I, Cikarang - Sukaresmi
Bekasi, 17550
Indonesia
Tel: +62 21 8990 6095
Fax: +62 21 8990 6096 / 1867
<http://www.Victortechnologies.com>

Victor Technologies, China

No 100 Lao Hongjing Rd
Minhang District
Shanghai, PR, 200235
Telephone: 86-21-64072626
Fax: 86-21-64483032

Victor Technologies Asia Sdn Bhd

Lot 151, Jalan Industri 3/5A
Rawang Integrated Industrial Park - Jln Batu Arang
48000 Rawang Selangor Darul Ehsan
West Malaysia
Telephone: 603+ 6092 2988
Fax : 603+ 6092 1085

Victor Technologies Italy

OCIM, S.r.L.
Via Benaco, 3
20098 S. Giuliano
Milan, Italy
Tel: (39) 02-98 80320
Fax: (39) 02-98 281773

Victor Technologies International

2070 Wyecroft Road
Oakville, Ontario
Canada, L6L5V6
Telephone: (905)-827-9777
Fax: 905-827-9797

Asia Pacific Regional Headquarters

71 Gower Street

Preston, Victoria, Australia, 3072

Telephone: +61 3 9474 7400

FAX: +61 3 9474 7391

Email: enquiries@cigweld.com.au

www.cigweld.com.au

CIGWELD